

**2023**

**ALUMINIO**







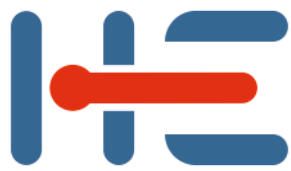

[www.herrajesuropeos.com](http://www.herrajesuropeos.com)

# CATÁLOGO ALUMINIO

**Agosto 2023**

Enero 2023



# Condiciones generales de venta

## 1- Envios

Los plazos de entrega oscilan entre las 24 y las 72 horas. No podemos garantizar estos plazos de entrega, si bien intentamos que las empresas de transporte los cumplan siempre que sea posible. En poblaciones rurales alejadas de núcleos urbanos no es posible garantizar en ningún caso la entrega en 24 horas.

Los plazos de entrega dependerán de la disponibilidad de cada producto. En los pedidos que incluyan varios artículos se intentará hacer un único envío, en caso de no poder servirse todo el material, se hará una segunda entrega con el material pendiente una vez esté disponible.

El cliente dispondrá de 48 horas para comprobar la integridad de todos los componentes del pedido y para comprobar que se incluye todo lo que debe en los productos incluidos. Pasadas estas 48 horas se dará por aceptado el envío y no se aceptarán reclamaciones por desperfectos o fallos con el envío.

En caso de recibir un producto dañado por el transporte es recomendable contactarnos dentro de las primeras 24h para ello, necesitamos que dejen constancia en el parte de entrega de la agencia de transporte.

## 2- Portes

Los portes para península y baleares correrán a cargo de Herrajes Europeos siempre que el pedido sea de 100€ o superior (importe neto, no está incluido el IVA). En caso de pedidos de menor importe, estos se cargarán en factura.

Envíos en los que 1 de sus bultos contengan una medida igual o superior a 3 metros, se verán incrementados en el 30% sobre el porte neto, con un mínimo de 75€.

Los portes para canarias correrán a cargo de Herrajes Europeos siempre que el pedido sea de 1.500€ o superior. En caso de pedidos de menor importe, el cliente podrá enviar a su agencia a recoger el material o bien, estos se cargarán en factura.

## 3- Devoluciones de mercancía:

Puede proceder a la devolución de productos en un plazo de 60 días desde la recepción de la mercancía por parte del cliente. Para ello se deben cumplir las siguientes condiciones:

Toda mercancía debe ser devuelta en su embalaje original con todos los accesorios que contenga, en perfecto estado y que no presente signos de manipulación. En caso contrario HERRAJES EUROPEOS S.L. se reserva el derecho de rechazar la devolución.

Solicitar el parte de devolución de material, el cual una vez rellenado y enviado a Herrajes Europeos se comprobará que es correcta la devolución y se avisará a la agencia de transportes para que proceda a la recogida.

Los gastos de transporte originados por error del cliente correrán a su cargo. Usted es libre de elegir y buscar la forma de hacerlo llegar a HERRAJES EUROPEOS S.L. Una vez recibida la mercancía y comprobada que está en perfectas condiciones, se tramitará la devolución del material. Le realizaremos el abono en un plazo máximo de 15 días naturales desde que se compruebe la devolución.

## 4- Información del catálogo:

Los artículos sin ninguna marca son artículos en stock en nuestro almacén de Valencia, los artículos con la marca naranja ■, indica que además del almacén de Valencia están en stock también en nuestro almacén de Mallorca y los artículos con la marca verde ■, indica que son artículos sobrepedido, no disponemos de stock en nuestros almacenes pero se pueden conseguir, siempre en cajas completas.

# INDICE

<b>1</b>	<b>Corredera</b>	<b>9</b>
	- Ruedas.....	9
	- Kits.....	25
	- Felpa.....	27
	- Cierres y uñas.....	28
	- Contracierres.....	32
	- Cierres multipunto.....	36
	- Manillas multipunto especiales y cierres centrales.....	44
<b>2</b>	<b>Elevable</b>	<b>49</b>
<b>3</b>	<b>Osciloparalela automática</b>	<b>52</b>
<b>4</b>	<b>Oscilos y líneas de manillas</b>	<b>54</b>
	- MR.....	54
	- MASTER.....	62
	- FAPIM.....	72
	- BLANDA anodizada.....	79
	- STAC.....	82
	- Mini ID.....	85
	- Curvo.....	86
	- Canal 16 (TYT y WK).....	87
<b>5</b>	<b>Practicable (ap. interior y ap.exterior)</b>	<b>89</b>
	- Apertura practicable y sistema de ventilación.....	89
	- Bisagras.....	90
	- Kits, pasadores, cerraderos y cerrojos.....	97
	- Cremona ap. exterior.....	102
	- Accesorios ap. exterior.....	103
	- Fast out.....	104
	- Cajas embutir.....	105
	- Compases y golpetes.....	106
	- Proyectantes y muro cortina.....	108
<b>6</b>	<b>Pivotante</b>	<b>110</b>
<b>7</b>	<b>Mallorquinas</b>	<b>111</b>
<b>8</b>	<b>Puerta de calle</b>	<b>117</b>
	- Cerraduras.....	117
	- Cilindros.....	125
	- Cerraderos.....	128
	- Control acceso.....	130
	- Tiradores.....	131
	- Cierrapuertas.....	135
	- Cortavientos.....	137
	- Otras manillas para puertas.....	139
	- Antipánicos.....	140
	- Sistema coplanar.....	143
	- Puertas.....	145
	- Paneles.....	149

<b>9</b>	<b>Motores de cadena y herrajes mando a distancia</b>	<b>150</b>
<b>10</b>	<b>Goma</b>	<b>153</b>
<b>11</b>	<b>Escuadras</b>	<b>164</b>
	- Escuadras de bloqueo.....	164
	- Escuadras tetón muelle.....	166
	- Escuadras varias y uniones.....	167
	- Escuadras de alineación.....	169
<b>12</b>	<b>Barandilla</b>	<b>171</b>
<b>13</b>	<b>Plegable</b>	<b>175</b>
<b>14</b>	<b>Aireadores</b>	<b>180</b>
<b>15</b>	<b>Sistemas de sellado</b>	<b>182</b>
<b>16</b>	<b>División de oficina</b>	<b>190</b>
<b>17</b>	<b>Varios</b>	<b>191</b>
<b>19</b>	<b>Mosquitera</b>	<b>197</b>
<b>20</b>	<b>Rales especiales</b>	<b>198</b>
<b>21</b>	<b>Catálogos HE QR</b>	<b>208</b>





## TIPOLOGIA



### 1.- RODAMIENTO DE BOLAS

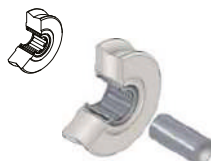

### 2.- RODAMIENTO DE AGUJAS CON EJE INOX + DELRIN



### 3.- RODAMIENTO DE AGUJAS CON EJE INOX + CASQUILLO INOX + DELRIN

MODELO RUEDA	PESO KGS HOJA (2 ruedas)			
	Bolas	Aguja	Eje + casquillo	Tipologia
Rueda nylon bolas	0 a 25			1
Rueda zamak simple bolas	0 a 30			1
Rueda zamak simple agujas		0 a 50		2
Rueda zamak doble bolas	0 a 60			1
Rueda zamak doble agujas		0 a 80		2
Rueda zamak PREMIUM simple aguja			0 a 75	3
Rueda zamak PREMIUM doble aguja			0 a 150	3
Rueda zamak PREMIUM INA doble aguja			250	3
Rueda zamak/nylon CONFORT bolas tandem	0 a 60			1
Rueda zamak/nylon CONFORT aguja tandem		0 a 80	0 a 200	2/3
Rueda elevable simple agujas			100	3
Rueda elevable tandem agujas			200	3
Rueda elevable tandem casquillo INA			300	3

## Diferentes diseños de rodamiento

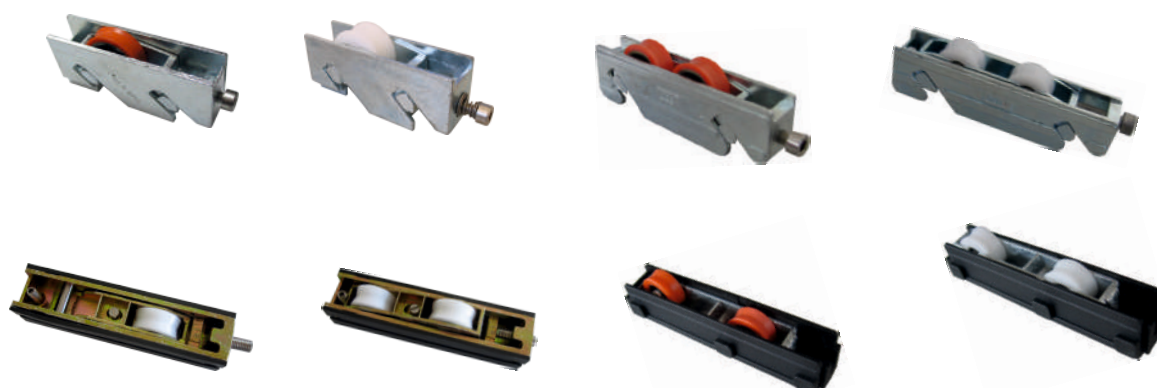
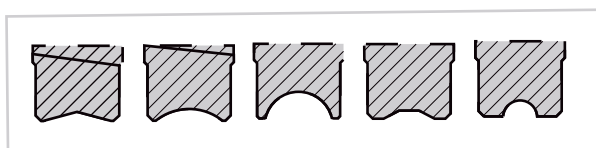

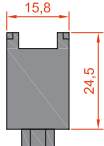
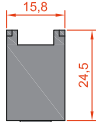
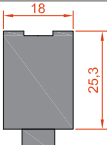
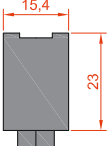
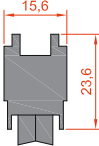
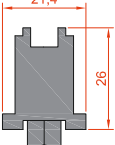
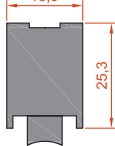
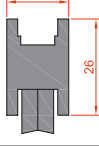
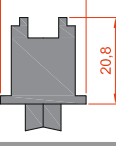
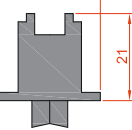

REFERENCIA	ROD. BOLAS CINCADO	ROD. AGUJAS CINCADO	MEDIDAS	
	CÓDIGO	CÓDIGO		
S/640 s/ 640, s/Junior, s/AL-21, s/1850, s/GP-65, s/800 Alugom, s/9060 Alcar, s/4900 Extol, s/Garbi 60 Tecalum	■ 3104	3890		200
S/2300 ANTIGUA s/2300 antigua	3088	3895		200
S/2300 NUEVA s/2300 nueva, s/c-23	3093	2311		200
S/ELITE VENTANA s/Elite Ventana, s/EU 200 Alugom, s/A-200, s/Domo 60 Indalsu	3172	106		250
S/C-60 GV s/GV-60, s/Diana Ventana	3161			250
S/5000 s/5000 cortizo	3100	8982		100
S/4400 s/4400, s/P60 Ayuso,	3099	3896		200
S/FORMA s/Forma Alumafel, s/ 1850At Exlabesa, s/C-62 galisur corte recto	3176	16048		250
S/GALA s/Gala Alumafel, s/P-60 Strugal, s/ Select P-60 codeval (perimetral)	3178	2931		250
S/AL-18 s/AL-18, s/C-70 Sopena/Provedal, s/2000 Cortizo, s/P65 Strugal, s/Inizio Evo3, s/GP65 Alumed/Galisur, s/Renova CO Centroalum, s/Alba 70 Barcelona, s/Nexus 70 Innaltech, s/VF70RT Teleprofil	3145	2038		150

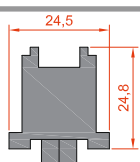
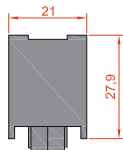
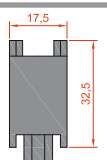
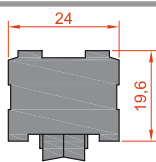
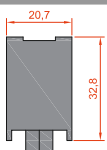
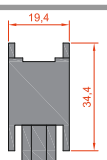
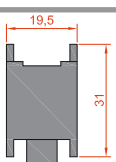
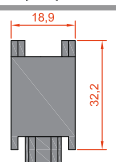
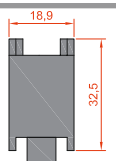
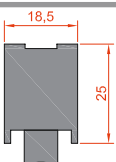

REFERENCIA	ROD. BOLAS CINCADO	ROD. AGUJAS CINCADO	MEDIDAS	
	CÓDIGO	CÓDIGO		
S/PLG s/PLG, s/LG perimetral, s/AL-18 Multipunto, s/PLG70 Balumco, s/Euronova P70 Al.Franco	3200	6480		200
S/AL-14 s/AL-14 Aluval/Extrual/Marton, s/P7180 costabrava, s/GV-65, s/CW-70, s/CW-75, s/G96, s/5200, s/1950, s/9010 Alcar, Marina 70 y 75 Inalum (Aldal)	3157	3155		150
S/700 s/700 Sopena	3114	3119		150
S/AL-18 /2500 s/800 perimetral Sapa/Alcoa, s/Alfa	9331	13305		150
S/C-2002 s/C-2002	3168	9363		100
S/LG s/LG, s/Giralda	3185	3867		150
S/V-68 s/V-68	3209			200
S/P-92 s/P-92, s/Aitana, s/800 Galsa, s/P-70 Galisur s/P92 Galisur	1896	3195		150
S/P-92 (Rodamiento al-24) s/P-70 Galisur o Codeval	3197			150
S/AL-24 s/Al-24 Aluval Extrual, s/Elite Puerta, s/Murcia, s/Gala 60, s/Elite Junior	3137	3887		200

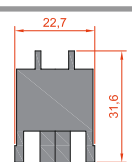
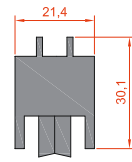
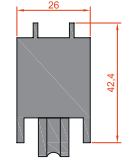
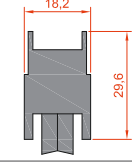
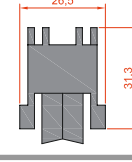
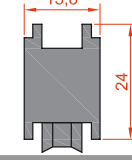
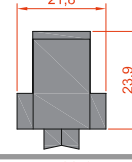
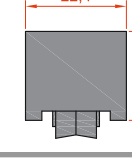
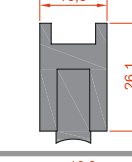
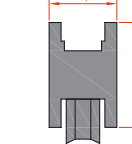

REFERENCIA	ROD. BOLAS CINCADO	ROD. AGUJAS CINCADO	MEDIDAS	
	CÓDIGO	CÓDIGO		
S/C-75 GV s/C-75 GV	3177	1067		150
S/V-82 s/V-82	3683			200
S/GV-909 s/GV-909 Sopena	3180			100
S/A-300 s/EU-300 alugom		3152		200
S/52.200 S/52.200		6294		100
S/BA-61 s/BA-61, C-95	18338			150
S/G-90 s/G-90, 5000 Simer, RM-71, s/S90 Extrugasa, s/RM71 Rominio/Q Systems	3174	11000		200
S/SLIDER s/Millenium, s/Slider Gallego Vilar, s/it-205 Exlabesa, s/3700 Extol, s/AL18 Labi/Aluval/Extrual, s/2000 Cortizo H.recta	3206	13497		200
S/6500 Simer S/6500 Simer corte recto	18141			200
S/AL-15 Multipunto S/3750 Mutlipunto Extol, s/Al15 Multipunto s/6500 Simer Perimetral	17450	17451		150



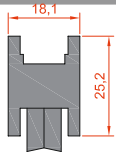
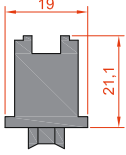
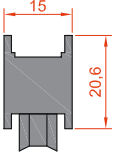
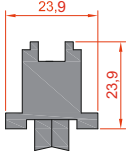
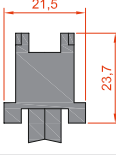
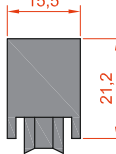
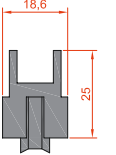
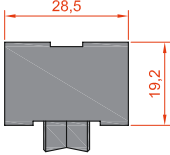
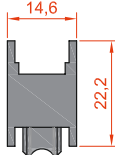
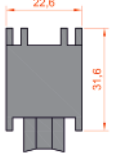

REFERENCIA	ROD. BOLAS CINCADO	ROD. AGUJAS CINCADO	MEDIDAS	
	CÓDIGO	CÓDIGO		
S/C-65 GV s/C-65 GV	3163	3162		250
S/AL-15 S/3750 Extol, s/Al-15 Aluval/Extrual, s/600P Alumarte, s/c-60 Sopena, s/AL-15 Alueuropa	10705	4804		200
S/P-60/65 s/P-60, s/P-65, s/P-62 Strugal	7535			300
S/P-70 s/P-70 Codeval, s/P70P Strugal, s/Alba 80 Barcelona, s/700P Alumarte, Apotema Cr89 Marton, s/70P Strugal	3190	2039		150
S/CONFORT s/Confort	8007	8008		250
S/IT-60 s/It-60	9663			250
S/VV60 s/VV-60	11193			250
S/VV85 S/VV-85, s/Catedral 85F-RPT Extruperfil * s/XS60RPT Extrugasa con calzo 14169	11194	13121		130
S/BL S/BL - Triana	3203			300
S/70.000 s/70000, s/7500 Itesal, s/Diana Puerta, s/23 Itesal	■ 3118	3116		100

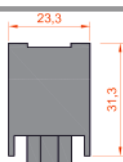
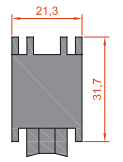
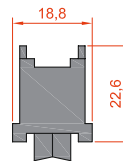
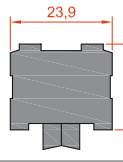
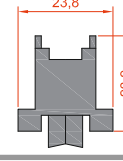

REFERENCIA	ROD. BOLAS CINCADO	ROD. AGUJAS CINCADO	MEDIDAS	
	CÓDIGO	CÓDIGO		
S/C-94 s/C-94	3165	4175		100
S/800 s/800 Sopena	■ 3124	3128		100
S/GAUDI	19402			200
S/COR 2000 S/2000 Cortizo Perimetral h.curva, Al-17 rotura, C-75	16564			200
S/PERIMETRAL 70 S/GFN-39 Perimetral Alugal, s/Silver 70 Alugom	6159	24430		250
4600	■ 16578	■ 16579		
400 ALUGOM	18515	24208		

**NOTA:** Disponemos de rodamientos de bronce. Consultar con departamento comercial.

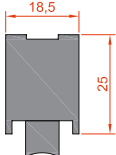
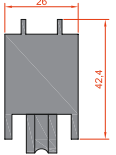
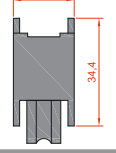
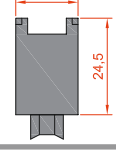
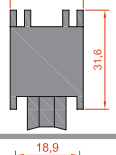
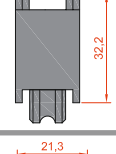
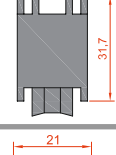
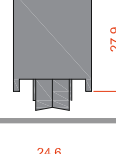
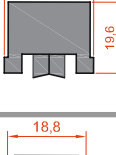
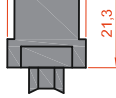

REFERENCIA	Zamak tandem rod.bolas	Zamak tandem rod. agujas	MEDIDAS	
	CÓDIGO	CÓDIGO		
S/AL-24 s/AL24 Aluval-Extrual, s/Gv65 Gallego Vilar, s/Elite Junior, s/Elite Puerta	3154	13693		150
S/GV-909	3736			100
S/LG s/LG Balumco, Giralda Extruperfil	5903	14484		150
S/640 s/640 Sopena, 9060 Alcar, s/Al-21 Aluval-Extrual, s/Garbi60 Tecalum, s/C60E Perfial, s/Jun21 Al.Franco, s/AE9000 Alcar, s/Ba61 Exlabesa, s/6500 Simer, s/Eur800 Aluqom, s/4900 Extol	8724	10012		200
S/70000 / C-94 s/23 Itesal		14483		100
S/P-92 s/GP92 Galisur	6669	16293		100
S/800 s/800 Sopena		11780		100
S/AL-14 s/AL-14 Aluval/Extrual, 9010 Alcar, s/7180, s/CW-70-7 s/C70-75 Inalum, Aldal, s/G96, s/1950, s/5200	6208	6209		100
S/AL-18 s/AL18, 9050-9051 Alcar, s/C70 Sopena, s/3700 Extol, s/800 perimetral Sapa-Alcoa, s/Inicio Evo 3, s/Alu13 -Alfa	■ 3147	8610		100
S/AL-15 s/Al15 Aluval, s/3750 Ayuso-Extol	13935	3143		150

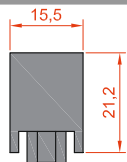
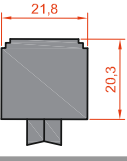
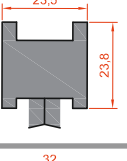
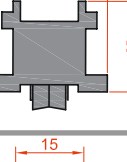
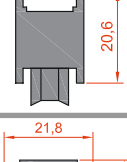
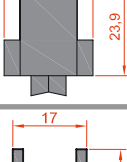
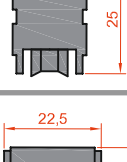
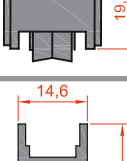
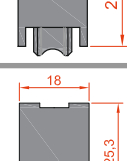
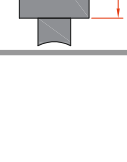

REFERENCIA	Zamak tandem rod.bolas	Zamak tandem rod. agujas	MEDIDAS	
	CÓDIGO	CÓDIGO		
S/IT-60	9848			200
S/IT-73* s/IT73 itesal, s/800 Perimetral Alcoa-Sapa	10236			100
* Carcasa exterior de plástico				
S/70 Perimetral s/70 Perimetral Apotema, p-70 Codeval s/700P Alumarte, s/70P Strugal, s/LR89 Marton	14954	16294		100
S/TPG-90 s/90P Strugal	16360	16577		100
S/P-65 s/P60-65-62 Strugal	8003			100
S/5000 / G-90 / P-650 s/G-90, 5000 Simer, RM-71, s/S90 Extrugasa, s/RM71 Rominio/Q Systems	14309			100
S/AL-15 MULTIPUNTO s/3750 Multipunto Extol	17452	17453		150
S/IT-205 s/IT-205, 13700 Toledo, s/AI18 Labi Aluval - Extrual, Millenium RPT	8088	12342		100
S/BL S/BL - Triana	20300			200
S/2300 nueva s/C-23, Alg 400,	15271	21543		200

# Ruedas zamak tándem regulables

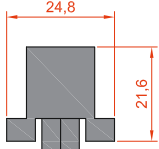
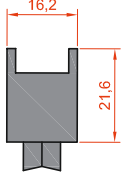

REFERENCIA	Zamak tandem rod.bolas CÓDIGO	Zamak tandem rod. agujas CÓDIGO	MEDIDAS	
S/4600 s/4600-2000 Cortizo	■ 18654	■ 18513		100
	■ 25487			150

# Ruedas zamak fija

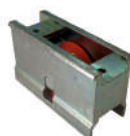

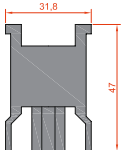
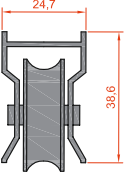

REFERENCIA	Zamak rod.bolas	MEDIDAS	
S/950	7661		50
S/6500 Cortizo, A-14 Alucan	21606		100



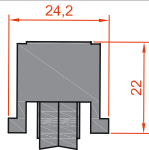
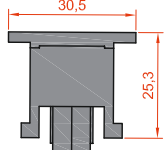
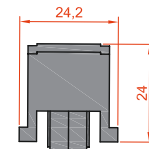
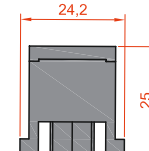
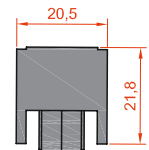
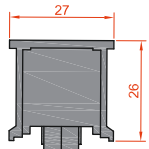
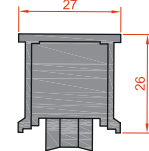
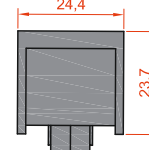
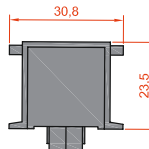
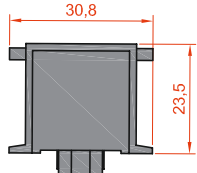

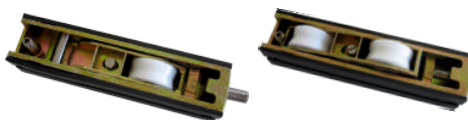
REFERENCIA	Rueda simple bicromatizada rod agujas	Rueda tandem bicromatizada rod agujas	MEDIDAS	
	CÓDIGO	CÓDIGO		
<b>B-1</b> Al-18 Multip,Alba 70 Al.Barcelona, Plg,8000 Extrugasa,C70 Inalum Aldal, Al-17 RPT, Millenium 63RPT Exlabesa, Exal Evolucion, 9050 Alcar, GFN-39 Perimetral Alugal	5097	5098		100
<b>B-1-5</b> Serie Unno Alumafel	5503	5452		100
<b>B-1-9</b> 400 Cortizo Corte Recto, Giralda Extruperfil, PLG Balumco, 4200 CR cortizo, s/CT Anicolor, P-70 Codeval	14496	■ 7745		110
<b>B-1-16</b> 6900RPT Simer, C-61 RPT Simer, C-61 Simer	17699	17698		100
<b>B-2</b>	9284	9285		100
<b>B-2-2</b> Alas 70 RPT, Alcar Ae9081, 60-85 Rominio, Q Systems, S90p Strugal, RQ rpt Centro Alum, Ae9052 corte recto	11988	■ 5454		100
<b>B-2-2 ESPECIAL</b>		■ 5453		100
<b>B-2-6</b>		14501		100
<b>B-2-8</b> Alfil rpt, C71a, Alba 80 rpt Al.Barcelona, Aluzal, 7500RPT simer,	5907	5301		100
<b>B-2-8 ESPECIAL</b> Cpt70 Extol (carril 800)	17202	17201		100

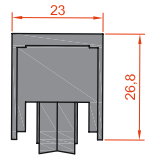
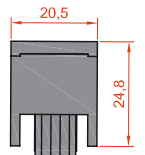
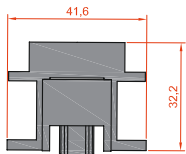
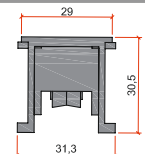
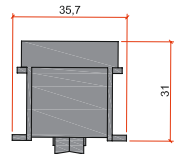
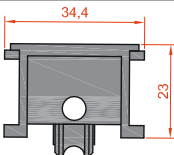
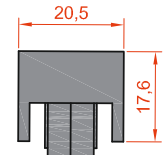
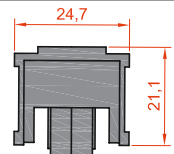
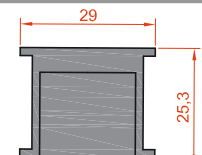

REFERENCIA	Rueda simple bicromatizada rod agujas	Rueda tandem bicromatizada rod agujas	MEDIDAS	
	CÓDIGO	CÓDIGO		
B-2-10 P74 rpt Codeval	6799	5455		100
B-2-16 s/4700 Cortizo	20942	20941		100
B-2-29 ESPECIAL Magna Thermic Alumed		23425		100
B-2-32 s/VF80RT Teleprofil		19334		100
B-2-38 ESPECIAL s/100 RPT Al. Franco	23515	23496		100
B-2-44 ESPECIAL s/CRS 77 Elite de Exlabesa	24797	24798		100
B-3 70 Extrugasa	6914	6915		100
B-3-1 Al 18 Aluval-Extrual, C70 y C75 Sopena, Alup17 rpt y fria, Marina RPT-75, Millenium Exlabesa, c-75RPT Inalum, 63RPT, Alba-80 Al.Barcelona, It-205 Exlabesa, VF70Rt -Teleprofil	5250	■ 5184		100
B-3-3 Silver 76RPT Alugom, C70 Eurocol Ayuso, Confort 90RPT Codeval, 80 RPT Itesal, CT70RPT Ayuso	7472	17279		100

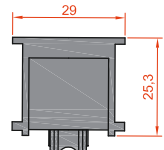
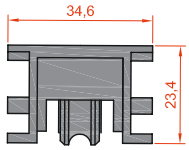
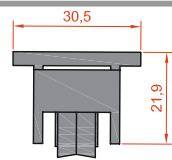
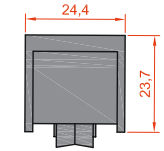
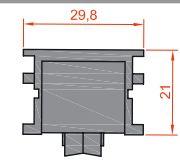
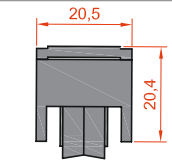
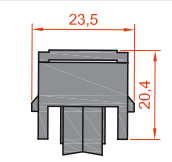
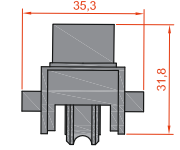
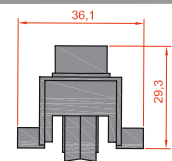
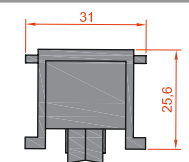

REFERENCIA	Rueda simple bicromatizada rod agujas	Rueda tandem bicromatizada rod agujas	MEDIDAS	
	CÓDIGO	CÓDIGO		
<b>B-3-3 ESPECIAL</b> Teknica, Tecnica Thermic CR, Tecnica Perimetral	17972	■ 13880		100
<b>B-3-4 ESPECIAL</b> 2000, Cortizo, 2070 Cortizo, Slide Gv,	25179	25180		80
<b>B-3-5</b> Alba 80		5456		100
<b>B-3-6</b> 4200 perimetral de Cortizo, Evo 3 rpt , 71 Laminex Eup 70 Benialu, 50 REU, Domo 80 Indalsu, 85 RT Indalsu, Alas 70, Simer 7700 RPT, Euronova P70 rpt al. Franco, CT Anicolor,	8899	■ 5457		100
<b>B-3-7</b>	25466	25467		100
<b>B-3-9 SIN POSTIZOS</b> s/Select P-60 Codeval Perimetral	9816	8787		100
<b>B-3-9</b> S90 y P70 Extrugasa, Silver 60 Alugom	17444	5459		100
<b>B-3-12 ESPECIAL</b> V-100 Sopena Elevable		6780		100
<b>B-3-13</b>		6664		100
<b>B-3-14</b> 9081 Alcar, AL-83 minimal Alcar,	17874	17873		100



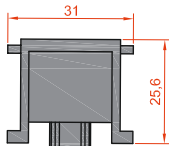
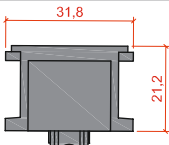
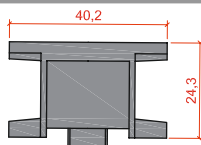
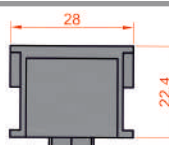
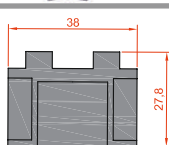
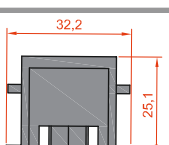
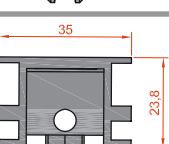
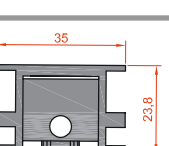

REFERENCIA	Rueda simple bicromatizada rod agujas	Rueda tandem bicromatizada rod agujas	MEDIDAS	
	CÓDIGO	CÓDIGO		
B-3-14 ESPECIAL	17217	17216		100
B-3-15 ESPECIAL	24795	24796		100
B-3-19 ESPECIAL 4900 HI RPT Cortizo,	23514	23401		100
B-3-20 MK s/80 las Islas, Sistemic 60	20240	20241		100
B-3-22 ESPECIAL s/CT-70, Europlus, Eurocor, Ayuso	24681	24682		100
B-3-24MK	20242	20243		100
B-3-26 It-61 Simer, Q-95 Q-System Perimetral s/Marina 90 Perimetral	1460	14610		90
B-3-26 ESPECIAL Itesal EVO-61 RPT Corte Recto y perimetral	18134	18135		90
B-3-27	18747	18748		100
B-3-27 ESPECIAL s/Indalsu 85RT + PLUS, s/ SLIM de exlabesa	18208	18209		80

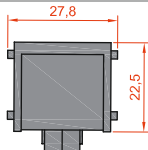
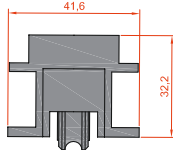
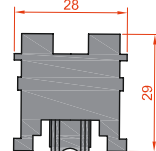
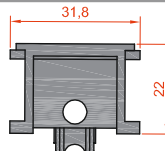
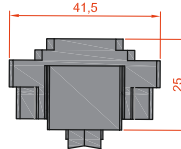
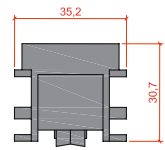
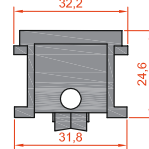
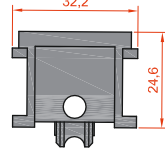

REFERENCIA	Rueda simple bicromatizada rod agujas	Rueda tandem bicromatizada rod agujas	MEDIDAS	
B-3-28 Thermia CF31-CR31 Fria y rotura, Catedral Extruperfil fria y rotura, Vv85 Fria y rotura	18204	18205		100
B-3-29 ESPECIAL Al-41 Aluval		18567		50
B-3-30 Extrual 75	18750	■ 18749		75
B-3-30 ESPECIAL	18753	18752		100
B-3-31 ESPECIAL Renova Eficiente	19541	19542		90
B-3-33	20357	20358		100
B-3-35 s/CRS-77 Exlabesa	20804	20803		60
B-3-36 s/86 RPT Strugal	14259	14123		100
B-3-36 ESPECIAL s/ Slide 120 Alugom	21414	21415		100
B-3-37 ESPECIAL		21500		100

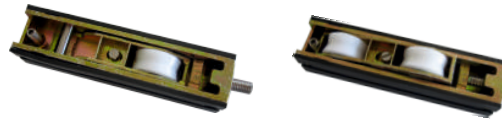

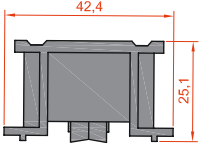
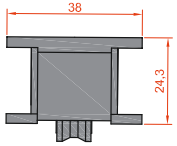
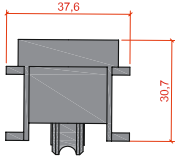
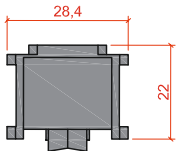
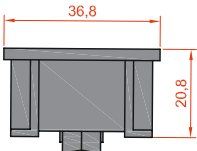
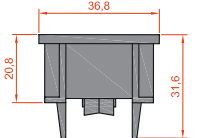
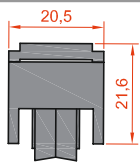
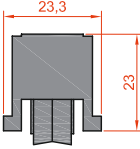
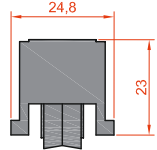
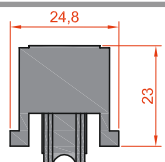

REFERENCIA	Rueda simple bicromatizada rod agujas	Rueda tandem bicromatizada rod agujas	MEDIDAS	
B-3-39MK	20244	20245		100
B-3-40 ESPECIAL	23862	23863		100
B-3-42 ESPECIAL ELEVABLE s/80 Extrual, s/110 Alugom, s/ Magna Thermic	24416	24374		100
B-3-43 s/Mediterraneo de Cortizo	24577			75
B-3-45	24764	24765		100
B-3-46	24766	24767		100
B-3-48	25468	25469		100
B-4 Silver 70 Alugom, V82 perfiles del cabo, Evolucion Exal		5392		100
B-5 P70 Coalsa, Silver 65 RPT, Alas 75	16828	■ 5451		100
B-5 ESPECIAL Rq Centroalum	15738	13364		100

# Ruedas PREMIUM regulables (rodamiento aguja)



1

REFERENCIA	Rueda simple bicromatizada rod agujas	Rueda tandem bicromatizada rod agujas	MEDIDAS	
B-5-9 Style 70 Alueuropa, Cp50 Reynaers	10136	10138		100
B-5-16 Ecothermic Slide Thecnal	17511	17510		100

## Ruedas CONFORT regulables



REFERENCIA	Rueda tandem rod bolas	Rueda tandem rod agujas	MEDIDAS	
	CÓDIGO	CÓDIGO		
C-1 s/C-97,s/C-97 RT, s/C-98RT Hidro - Expral, s/GPR-90 RPT Galisur, s/6800 Simer, s/6800 RPT, s/CT-87 Alugal	12681	12682		100
C-2		18210		100
C-3 s/Magna Extrual, s/75 Marton s/ Gp90 Galisur	13547	13546		100
C-4 Strugal S90P, s/Alba Pros 80RPT Al.Barcelona s/ Sintermic 60	16891	14749		100

## Ruedas nylon

CODIGO	SERIE	
9940	s/400 Alugom	200
7049	s/4400/2300 HJ	200
3110	s/640	250
■ 21313	s/70p Strugal	200
9137	s/A-300	200
7930	s/AL-14/Marina/7180/9051	300
3151	s/Al-24/Elite puertaElite junior/Tk70	300

CODIGO	SERIE	
3202	s/BL Triana	500
10909	s/C-95	500
5809	s/Diana Puerta/C-94/70000/800	200
■ 17679	s/Diana Ventana	200
3205	s/LG Giralda	150
■ 9220	s/P-60-65/P-62 Strugal	100
3192	s/P-92/P-70	300
11191	s/VV60	1000





Kits corredera guiados color negro

CODIGO	REF.	EXTRUSOR	
2350	700	Sopena	100
2403	C94	Expral	50
11097	MARINA 75	Aldal	50

Kits corredera corte recto guiados con cortavientos CAUCHO, color negro

CODIGO	REF.	EXTRUSOR	
2389	640/AL-21/IT27	Sopena / Itesal	50
2326	2300 ANTIGUO	Sopena / Itesal	100
2328	2300 HJ NUEVO	Sopena / Itesal	50
■ 2372	800	Sopena / Itesal	50
2361	70.000/ IT-23	Sopena / Itesal	50
2493	P92	Galisur	50
2490	P70	Galisur	50
2434	Gv909	Sopena	50
■ 2379	800 MULTIPUNTO	Sopena	75
7660	950R		50
2386	AL-14	Aluval	60
17138	AL-24	Aluval	75
2315	2002A	Expral	50
2317	2002B	Expral	50
10539	C-95	Expral	75
2417	ELITE JUNIOR	Alumed	50
16526	ELITE PUERTA	Alumed	50
16401	A-400	Alugom	100

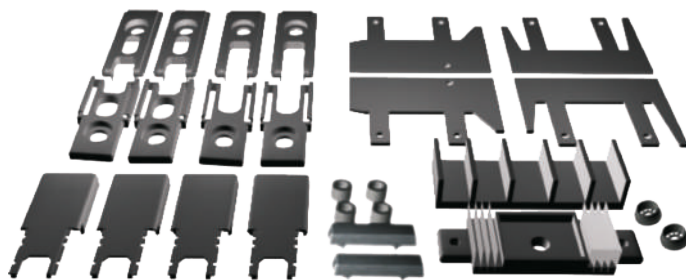

Kits corredera corte recto superpuestos con cortavientos PELO, color negro

CODIGO	REF.	EXTRUSOR	
2471	MARINA 70	Aldal	50
2473	CW-75	Aldal	50
10820	TRIANA-BL	Proveedora	100

Kits corredera corte recto superpuestos con cortavientos CAUCHO

CODIGO	REF.	EXTRUSOR	
2494	P92	Galisur	50
■ 2392	AL-24	Aluval	50
2466	LG	Proveedora	50
2397	BA-61	Exlabesa	100
2419	ELITE VENT	Alumed	50
2380	Eu200	Alugom	50
2387	AL-14	Aluval	50
2390	640/AL-21HE/IT27	Sopena - Itesal	75
17277	640/AL-21/IT27	Sopena - Itesal	50
2418	ELITE PUER	Alumed	50
16388	ELITE JUNI	Alumed	50
2381	A300	Alugom	50
2486	P65/P62	Galisur	100
21881	6500 Cortizo	Simer	100
7937	EURO 1000	Expral	100
9219	CW-70	Aldal	100
16393	P-70	Galisur	100

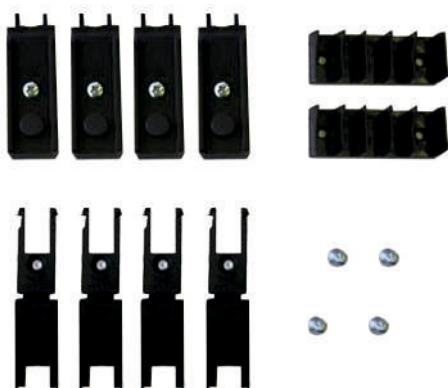

Kits perimetral, color negro

CODIGO	REF.	EXTRUSOR	
6157	AL-15/ C-60	Aluval	35
■ 8499	AL-18-17	Aluval	35
■ 5595	C70	Sopena	100
5594	C75	Sopena	40
8502	IT-205	Exlabesa	100
16419	IT-60	Exlabesa	50
7691	MAGNA	Alumed	50
2474	MILLENIUM	Exlabesa	50
8161	P-60	Galisur	150
16406	SLIDER	Laminex	35
17604	EX-75 FRIA	Extrual	40
■ 24393	EX-75 RPT	Extrual	20
21060	EX-80	Extrual	-
21791	P70	Extrugasa	35

## Flexiband

### Flexiband

CODIGO	MEDIDAS	COLOR	SERIE	
2022	3 X 18	Negro	BL	1300
2023	3 X 20	Negro	640/2300	288
2024	3 X 22	Negro	700/2300	280
2025	4 X 22	Negro	700	264
2026	4 X 25	Negro	800/70000/P-92	264

## FELPA SIN LAMINA



CODIGO	MEDIDA A x B	COLOR	
1822	3,8 x 6,5	Negro	2000
6048	4,8 x 6	Negro	1800
1826	4,8 x 7	Negro	1600
1828	4,8 x 8	Negro	1600
13037	4,8 x 9	Negro	1200
8385	4,8 x 10	Negro	1000
1830	4,8 x 15	Negro	800
17306	5,1 x 8	Negro	1300
14555	5,2 x 5	Negro	2000
1835	5,2 x 6	Negro	1800
9125	5,9 x 4	Negro	2000
1848	6,5 x 5	Negro	1800
1863	6,8 x 4	Negro	2000
1923	6,8 x 4,5	Negro	1800
■ 1868	6,8 x 5	Negro	1800
1927	6,8 x 5,5	Negro	1600
■ 1874	6,8 x 6	Negro	1600
1930	6,8 x 6,5	Negro	1400
■ 1877	6,8 x 7	Negro	1300
1880	6,8 x 9	Negro	1100
2006	7 x 8	Negro	1100
1967	7 x 10	Negro	1000
1969	7 x 11	Negro	800
1972	7 x 15	Negro	600
1958	7,2 x 6	Negro	1600
6049	7,5 x 9	Negro	900
16530	14 x 10	Negro	100
16175	57 x 8	Negro	100

CODIGO	MEDIDA A x B	COLOR	
1823	4,8 x 5	Gris	2000
5219	6,8 x 5	Gris	1800
1873	6,8 x 6	Gris	1600

Otras medidas consultar Dep. Comercial

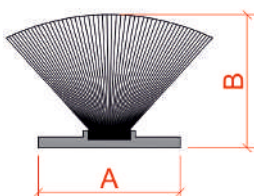

## FELPA CON LAMINA



CODIGO	MEDIDA A x B	COLOR	
1825	4,8 x 7	Negro	1200
15812	4,8 x 9	Negro	750
11428	4,8 x 10	Negro	900
12018	5,5 x 5	Negro	1500
12017	5,5 x 6	Negro	1350
12016	5,5 x 10	Negro	1350
1862	6,8 x 4	Negro	1650
1922	6,8 x 4,5	Negro	1650
■ 1867	6,8 x 5	Negro	1500
1926	6,8 x 5,5	Negro	1425
■ 1872	6,8 x 6	Negro	1350
1929	6,8 x 6,5	Negro	1275
■ 1876	6,8 x 7	Negro	1200
12015	6,8 x 8,5	Negro	750
6777	6,8 x 9	Negro	750
14199	6,8 x 10	Negro	600
20910	6,8 x 13	Negro	450
2000	7 x 7,5	Negro	1050
2004	7 x 8	Negro	900
1957	7,2 x 6	Negro	1125

CODIGO	MEDIDA A x B	COLOR	
1866	6,8 x 5	Gris	1500
5218	6,8 x 6	Gris	1350
2008	7 x 9	Gris	750

Otras medidas consultar Dep. Comercial

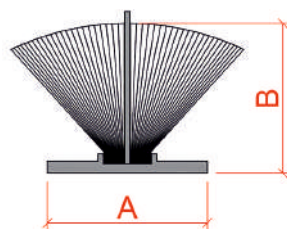

## FELPA TRI BAND



CODIGO	MEDIDA A x B	COLOR	
18635	6,8 x 5	Negro	1400
18636	6,8 x 5,5	Negro	1400
■ 18637	6,8 x 6	Negro	1200
■ 18638	6,8 x 6,5	Negro	1200
■ 18639	6,8 x 7	Negro	1000
■ 18640	6,8 x 7,5	Negro	1000
■ 18641	6,8 x 8	Negro	600
18645	6,8 x 9	Negro	400
■ 23573	6,8 x 10	Negro	600
■ 22390	6,8 x 11	Negro	600
■ 22391	6,8 x 12	Negro	500

Otras medidas consultar Dep. Comercial

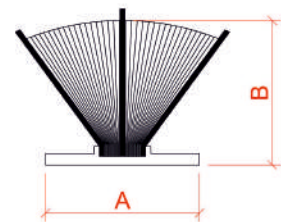

## FELPA MONO BAND



CODIGO	MEDIDA A x B	COLOR	
24584	6,8 x 5	Negro	1500
24585	6,8 x 5,5	Negro	1275
24586	6,8 x 6	Negro	1200
24587	6,8 x 7	Negro	1050
24589	6,8 x 7,5	Negro	1050
24590	6,8 x 8	Negro	900
24591	6,8 x 9	Gris	750
24592	6,8 x 10	Negro	600

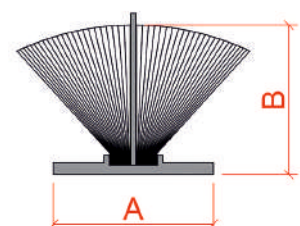



■ **CÓDIGO:** 3794 **REF.:** U-90010  
Uña 2029

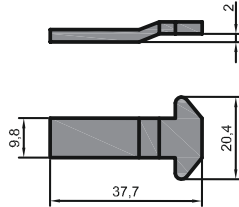

■ **CÓDIGO:** 10533 **REF.:** 2030  
Uña 2030

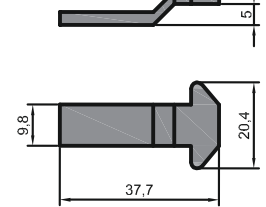

■ **CÓDIGO:** 18801 **REF.:** G043520  
Uña para serie Extrual 75

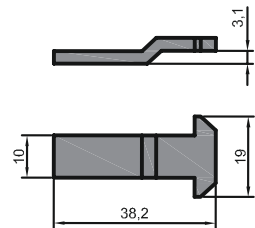

**CÓDIGO:** 19981 **REF.:** G91520  
Uña para serie BX-65

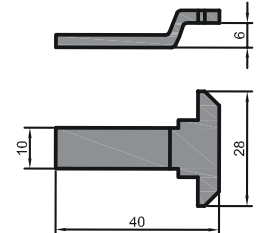

■ **CÓDIGO:** 9797 **REF.:** 2035

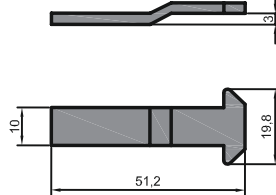

**CÓDIGO:** 19830 **REF.:** 2033  
Uña 2033 s/EVO-61

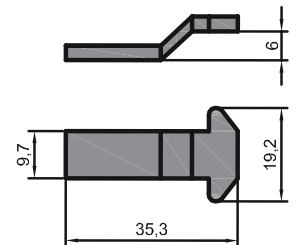

**NOTA:** Uña especial para la s/800 Multipunto

**CÓDIGO:** 23450 **REF.:** G083

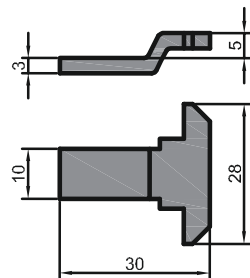

■ **CÓDIGO:** 18138 **REF.:** 4307  
Uña 4307 para perimetral para cierre 4308 - 4309

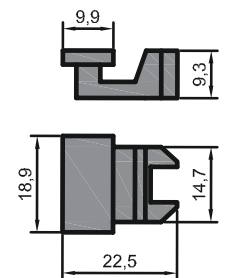

**CÓDIGO:** 15345 **REF.:** 4307G  
Para cierre 4308 - 4309

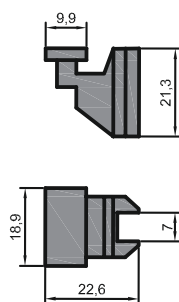

**CÓDIGO:** 18317 **REF.:** B038500  
Prolongador uña

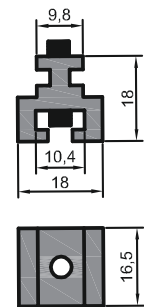

**CÓDIGO:** 3793 **REF.:** U-90009  
Uña HE para perimetral (4-2-Z)

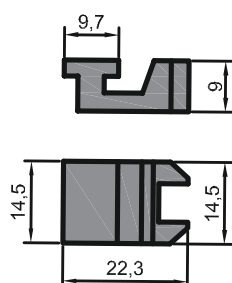

**CÓDIGO:** 9072 **REF.:** 36  
Uña perimetral rebajada, especial para perfiles de 60 mm.

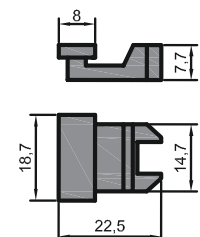
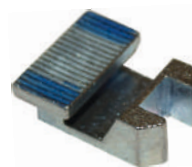



Cierre embutido con tornillos económico sin condena.

CODIGO	REF.	COLOR	
2033	2170	Blanco	50
4143	2170	Negro	50

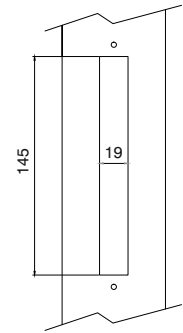
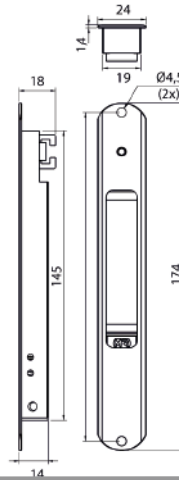

Cierre embutido sin tornillos económico. El mismo incluye con y sin condena.

CODIGO	REF.	COLOR	
9340	2172	Blanco	20
2712	2172	Negro	20

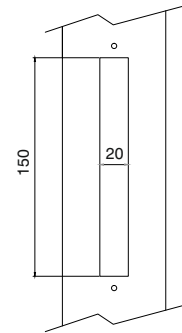
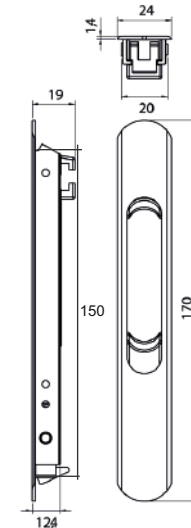

Cierre embutido sin tornillos económico ancho. El mismo incluye con y sin condena.

CODIGO	REF.	COLOR	
9339	2175	Blanco	50
7479	2175	Negro	50

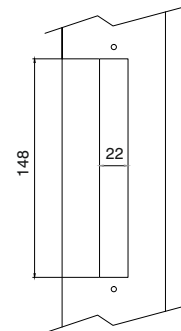
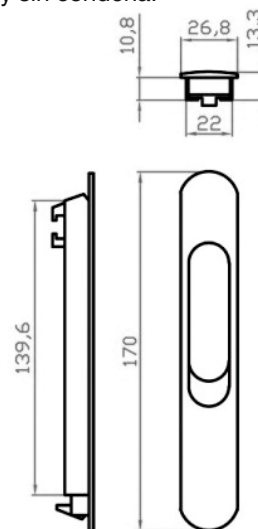

CÓDIGO: 7480 REF.: 2175  
Uña centrada para cierre 2172 y 2175

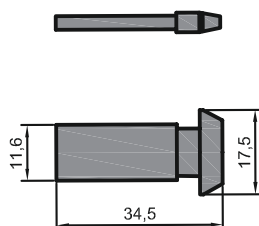

CÓDIGO: 4229 REF.: 2172  
Uña desplazada para cierre 2172 y 2175

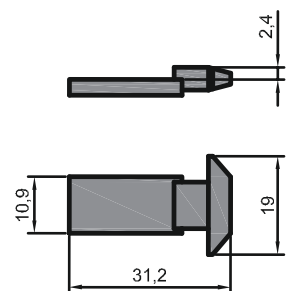
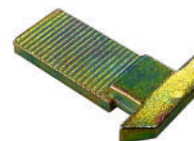



## Cierre E45 corredera pequeño COMBI con tornillos

CODIGO	REF.	COLOR	
24213	E45	Blanco	100
24214	E45	Negro	100

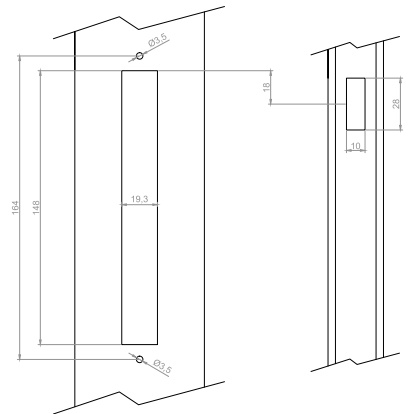
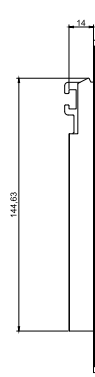
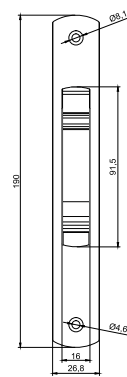

## Cierre E70 corredera grande COMBI con tornillos

CODIGO	REF.	COLOR	
24215	E70	Blanco	100
24216	E70	Negro	100

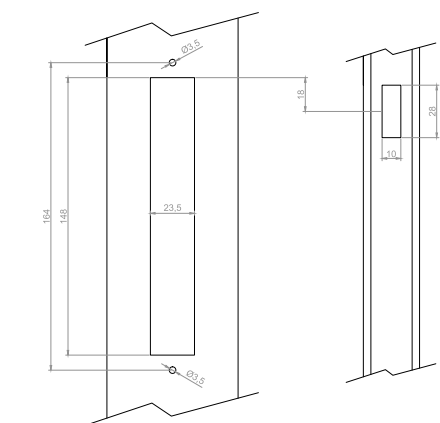
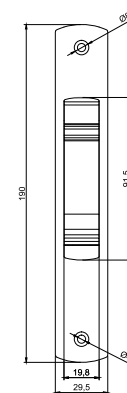

## Asa 4210 para cierre E45 y E70

CODIGO	REF.	COLOR	
24	4210	Blanco	24
26	4210	Negro	24

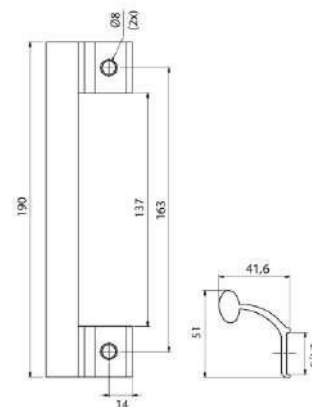

### CÓDIGO: 5808

Uña desplazada cierre E-45-70/33 corredera

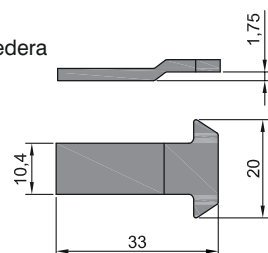

### CÓDIGO: 24218

Uña recta E-45-70/33MM FR

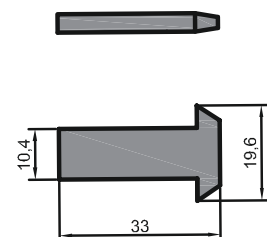

### CÓDIGO: 17854

Uña desplazada E-45-70/41MM

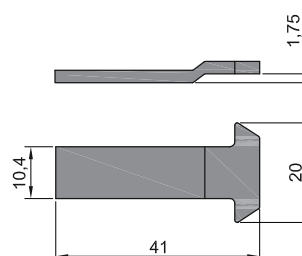

### CÓDIGO: 8933

Uña cierre E-25 perimetral

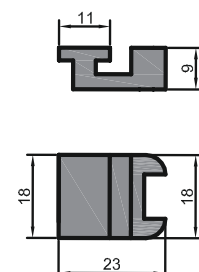

■ **CÓDIGO: 936 + 1667 (esparrago)**  
 Contracierre para la serie P92, Aluprom 24 y Elite Puerta

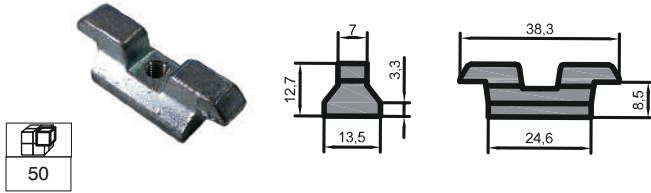

**CÓDIGO: 908**  
 Contracierre para la serie 2300 (atornillado), Diana Ventana y Universal

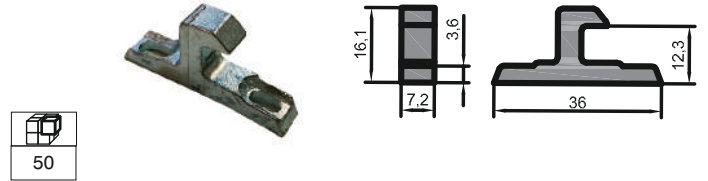

**CÓDIGO: 922**  
 Contracierre para las series Diana Ventana y 2300

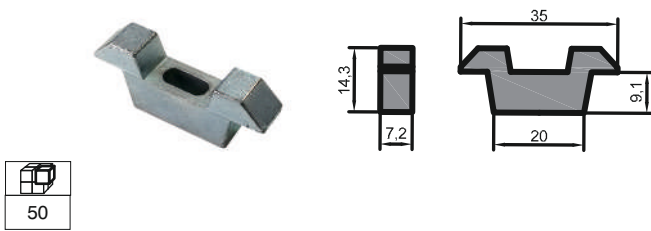

**CÓDIGO: 934 + 1667 (esparrago)**  
 Contracierre para las series LG y Giralda

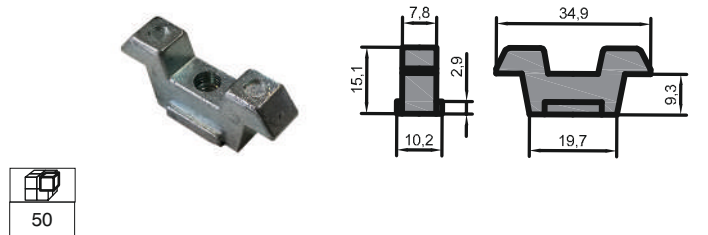

**CÓDIGO: 913 + 1667 (esparrago)**  
 Contracierre para la serie 6000, 700, 2300

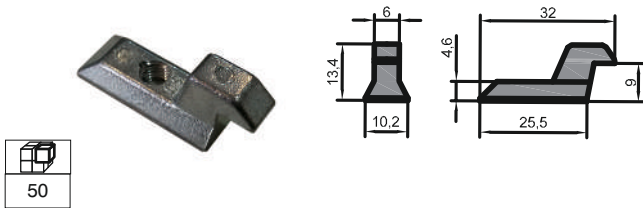

**CÓDIGO: 914 + 1667 (esparrago)**  
 Contracierre para la serie AL-21

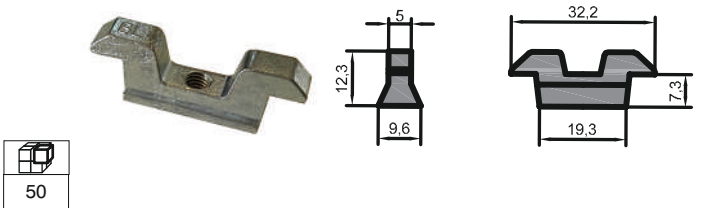

**CÓDIGO: 918 + 1667 (esparrago)**  
 Contracierre para la serie 7180 y V-47

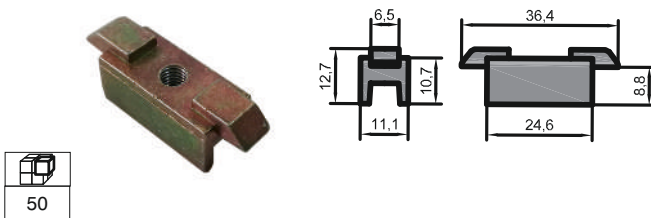

■ **CÓDIGO: 920 + 1667 (esparrago)**  
 Contracierre para la serie 800

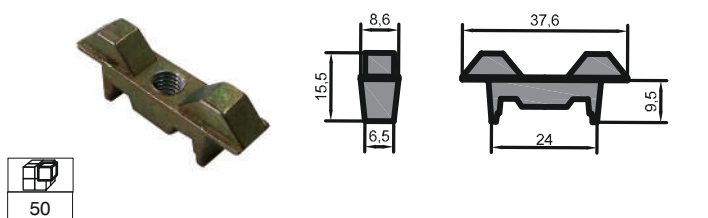

■ **CÓDIGO: 917**  
 Contracierre para la serie 70000

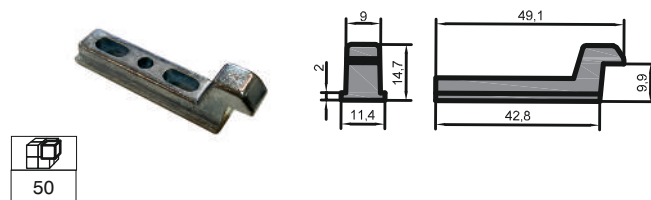

**CÓDIGO: 910 + 1667 (esparrago)**  
 Contracierre para la serie 2300, 400 Alugom, Elite Ventana

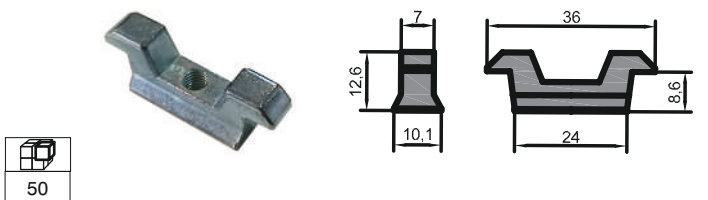

**CÓDIGO: 939 + 1667 (esparrago)**  
 Contracierre para la serie BL

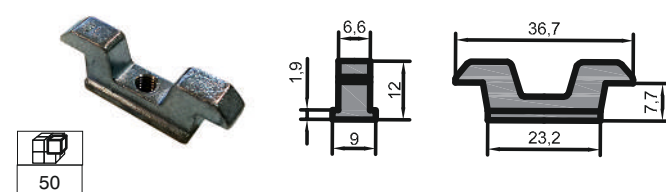

**CÓDIGO: 930 + 1667 (esparrago)**  
 Contracierre para la serie G-90 y 5000

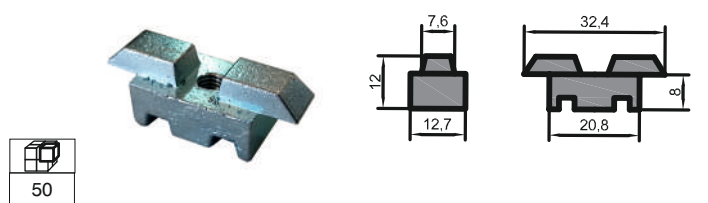

CÓDIGO: 926 + 1667 (esparrago)  
 Contracierre para las series 300 Alugon

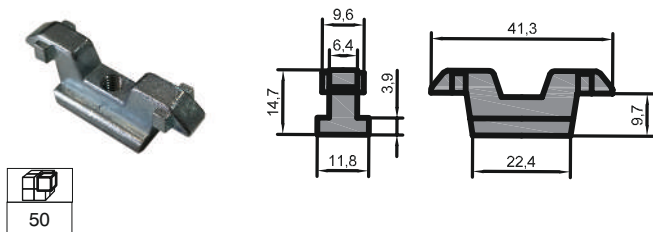

CÓDIGO: 935 + 1667 (esparrago)  
 Contracierre para las series Marina y G-96

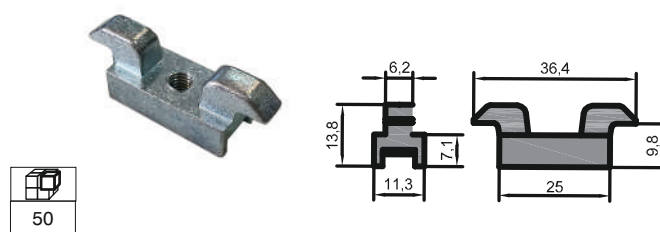

CÓDIGO: 15204  
 Contracierre para la A-14 Alucan, 6500 Cortizo

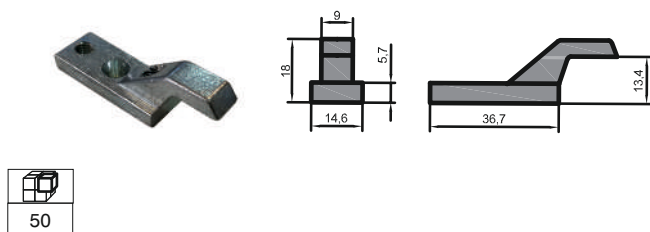

CÓDIGO: 924 + 1667 (esparrago)  
 Contracierre para las series BA-61

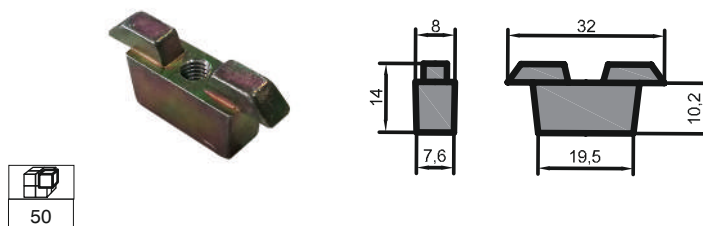

■ CÓDIGO: 14173 + 1663 (esparrago)  
 Contracierre para Extrual 75

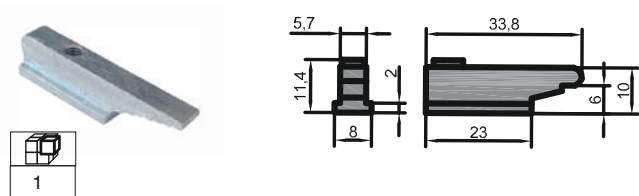

CÓDIGO: 13469 + 1667 (esparrago)  
 Contracierre para la serie Tecnika

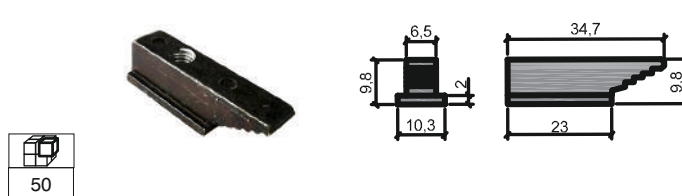

CÓDIGO: 16975  
 Contracierre para la serie A-15 Alucan

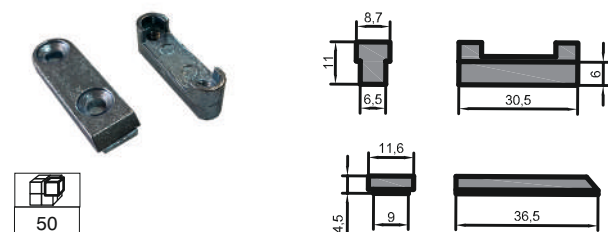

CÓDIGO: 20285 + 1667 (esparrago)  
 Contracierre perimetral para la serie VV85

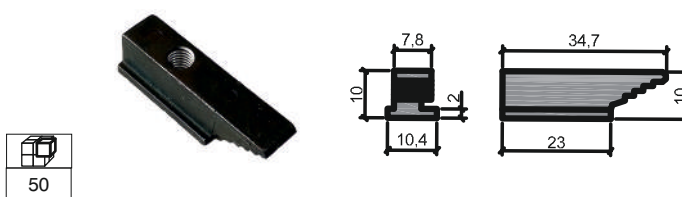

CÓDIGO: 912  
 Contracierre para la serie 4400, 44PC y 9200

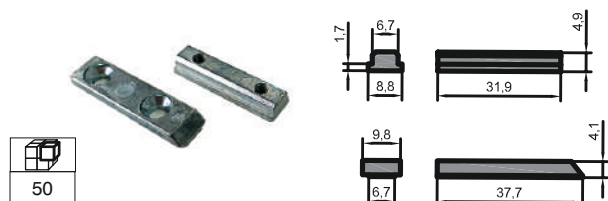

CÓDIGO: 24718  
 Contracierre para la serie TECNICA (fijación inox)

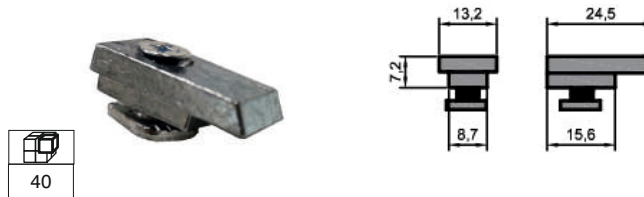

CÓDIGO: 921 + 1663 (esparrago)  
 Contracierre para la serie 800 y GV-75

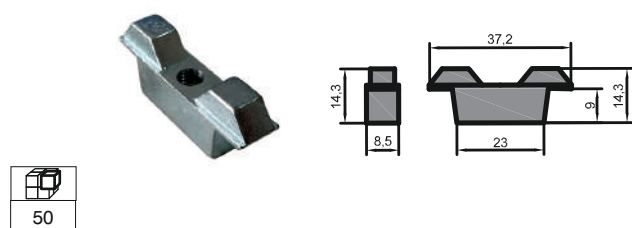

**CÓDIGO: 916**

Contracierre para las series 70000 y perimetral

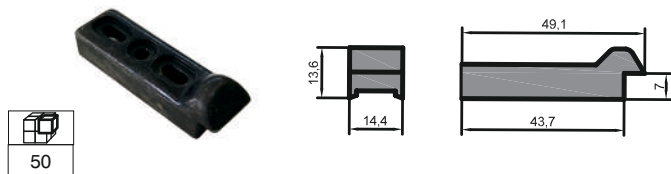

**CÓDIGO: 16371**

Contracierre perimetral mediano

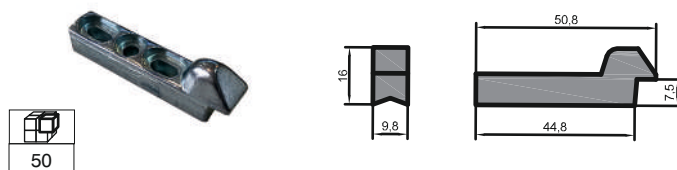

**CÓDIGO: 911**

Contracierre perimetral 4302

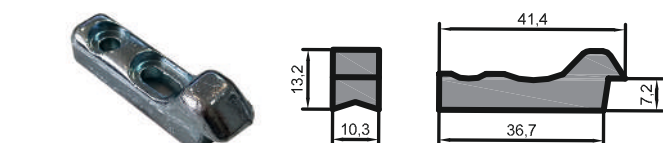

**CÓDIGO: 12591**

Contracierre perimetral 4301

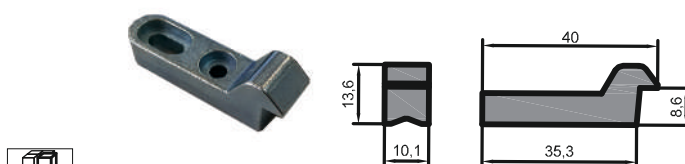

**CÓDIGO: 915**

Contracierre perimetral para la serie AL-15



**CÓDIGO: 7857**

Kit microventilacion perimetral para cierre 4308 y 4309.

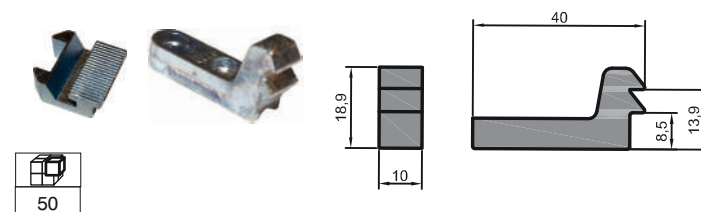

**CÓDIGO: 928**

Contracierre para E-25 perimetral.

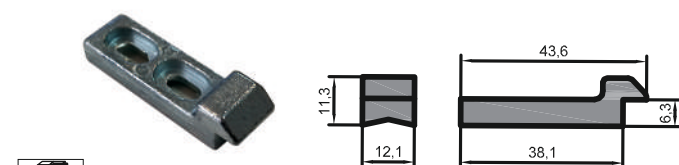

**CÓDIGO: 5014**

Contracierre 1420 para perimetral

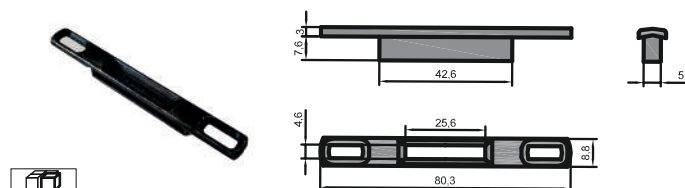

**CÓDIGO: 931**

Contracierre 10047 para cierre 4308

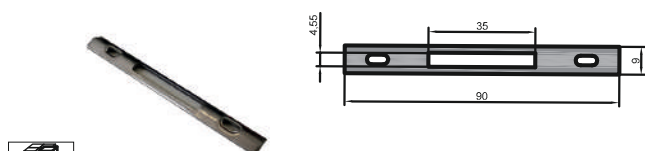

**CÓDIGO: 933**

Contracierre inox 2,5 Syncar

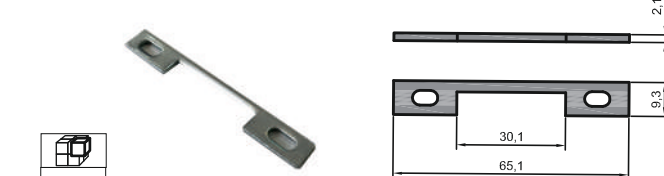

## Calce apoyo cerradero

CODIGO	REF.	CODIGO TORNILLO
23584	ALBA PROS 70 RPT ALBA PROS 85 RPT	22090
11313	EXTRUAL 75 SYSTEMIC 60 ALUGAL RPT	23422
11341	EVO 61 ROTURA	23421
11339	TEKNICA	



## Chapa contracierre

CODIGO	REF.
23827	EXTRUAL 75
23828	EVO 61 ROTURA
■ 23829	TEKNICA

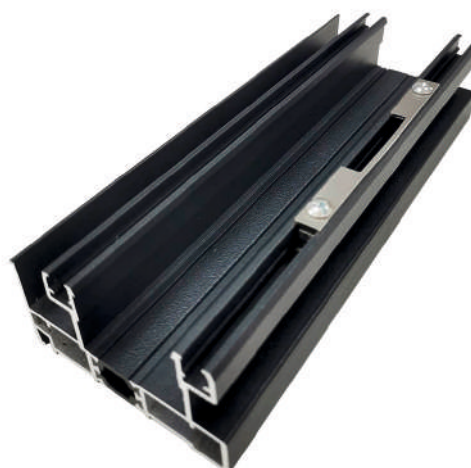
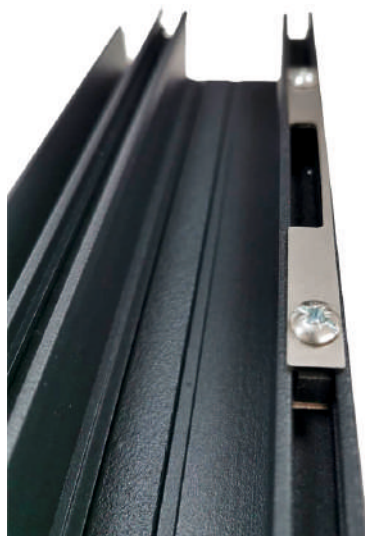

1

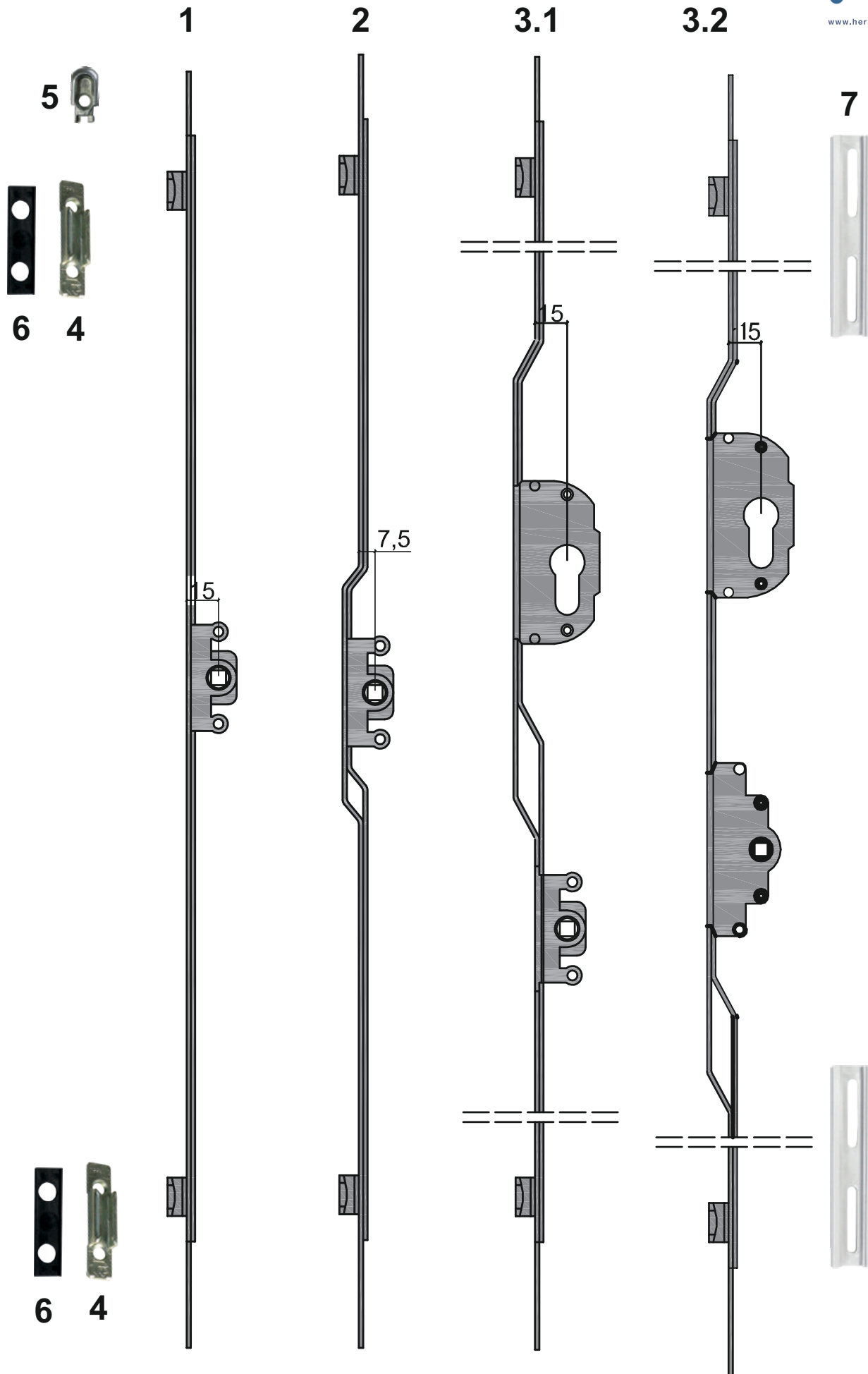



## Cremona Entrada 15 Modelo TYT.

1

CODIGO	MEDIDA ALTO	Nº BULONES	COTAS MANILLAS	
9081	210	1	-	20
9083	600	2	300	20
9077	1.000	2	500	20
9086	1.600	3	800	20
9079	1.800	3	900	20

## Cremona Entrada 7,5 Modelo TYT.

2

CODIGO	MEDIDA ALTO	Nº BULONES	COTAS MANILLAS	
9082	270	1	-	20
9084	600	2	300	20
9078	1.000	2	500	20
9087	1.600	3	800	20
9080	1.800	3	900	20

## Cremona Entrada 15 con llave

3.1

3.2

CODIGO	MEDIDA ALTO	Nº BULONES	COTAS MANILLAS	MODELO	
9180	1.600	3	800	TYT	20
986	1.600	2	800	GU	20

## Cerraderos.

4

CODIGO	REF.	SERIE	
318	13880	Standard	100
468	E-13880-06-0-1	800 multip	-
17078	3600011M	Guiado	-
16280	TRK		100
18427		Standard INOX	100

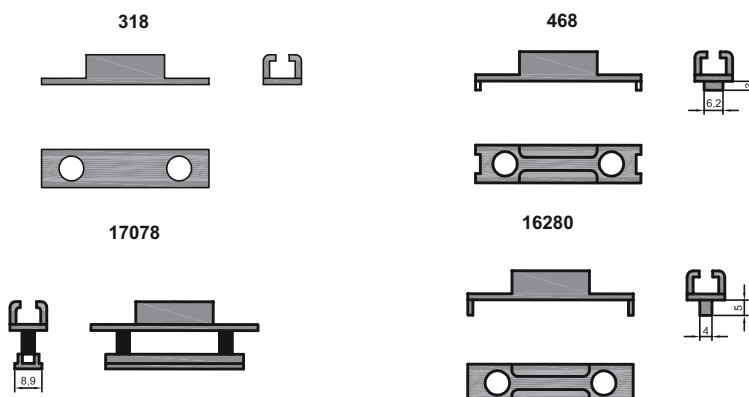

## Seguro Antielevacion.

5

CODIGO	REF.	
338	18196	50



## Calce Cerradero.

6

CODIGO	REF.	
369	55-12-5	200
370	55-12-EZ	200
11621	55-12-10	200
6766	s/800	200

369 (5512-5)

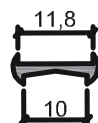

370 (5512-EZ)

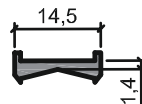

11621 (5512-10)

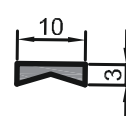

6766 (S/800)

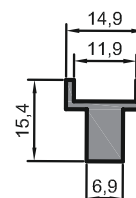

7

Ver calzos de apoyo cremona en pag. 41

1

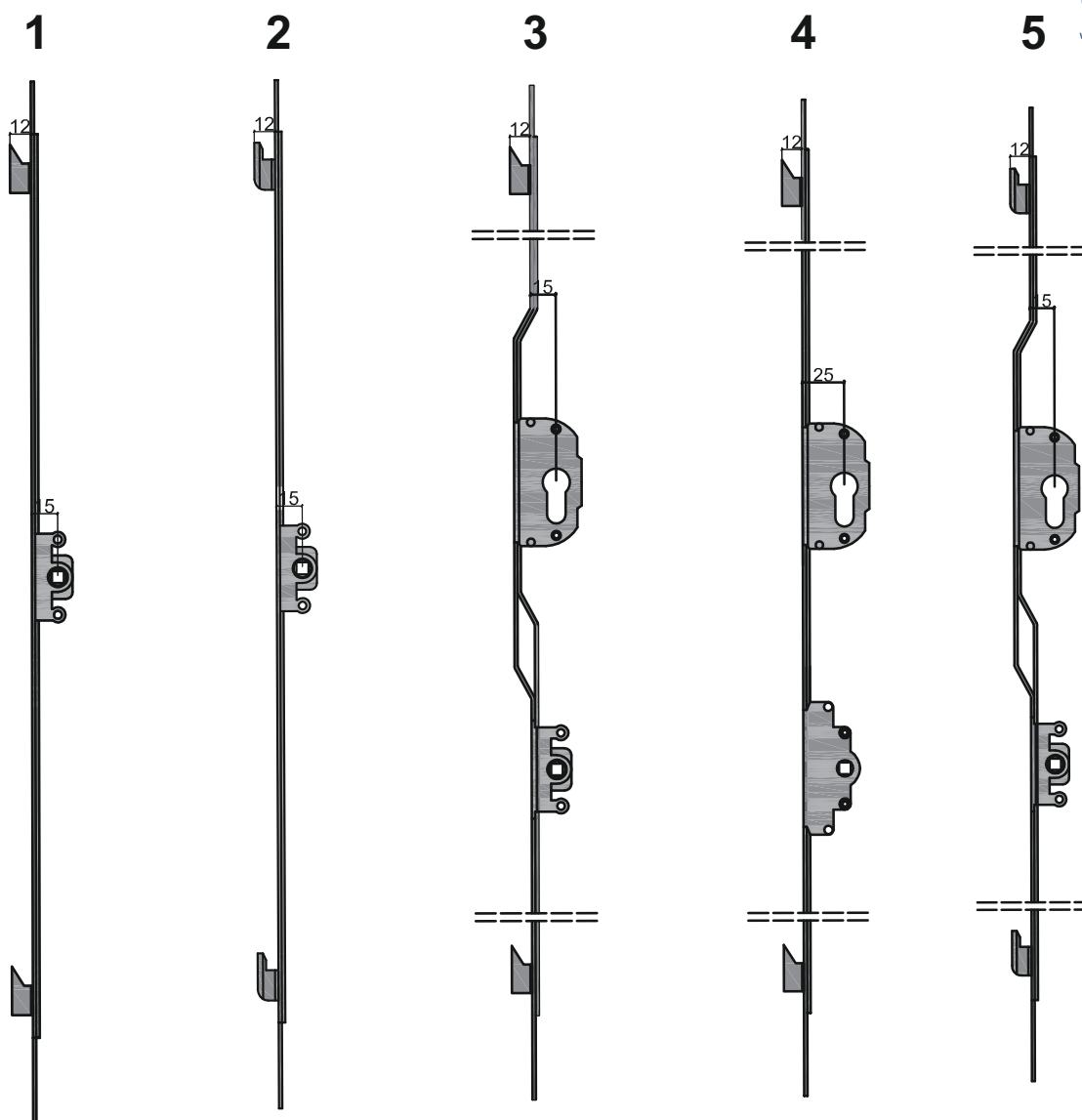

## 1 Cremona Entrada 15 Modelo Gancho Corto.

CODIGO	MEDIDA ALTO	Nº BULONES	COTAS MANILLAS	
5635	210	1	-	20
■ 15781	600	2	300	20
328	1.000	2	500	20
■ 15782	1.600	3	800	20

## 2 Cremona Entrada 15 Modelo Gancho Recto.

CODIGO	MEDIDA ALTO	Nº BULONES	COTAS MANILLAS	
24212	210	1	-	20
24164	600	2	300	20
24165	1.000	2	500	20
24166	1.600	3	800	20

## 3 Cremona Entrada 15 con llave. Modelo Gancho Corto.

CODIGO	MEDIDA ALTO	Nº BULONES	COTAS MANILLAS	
20911	1600	3	800	-

## 4 Cremona Entrada 25 con llave. Modelo Gancho corto

CODIGO	MEDIDA ALTO	Nº BULONES	COTAS MANILLAS	
18090	1600	2	800	-

## 5 Cremona Entrada 15 con llave. Modelo Gancho recto.

CODIGO	MEDIDA ALTO	Nº BULONES	COTAS MANILLAS	
24167	1600	3	800	-



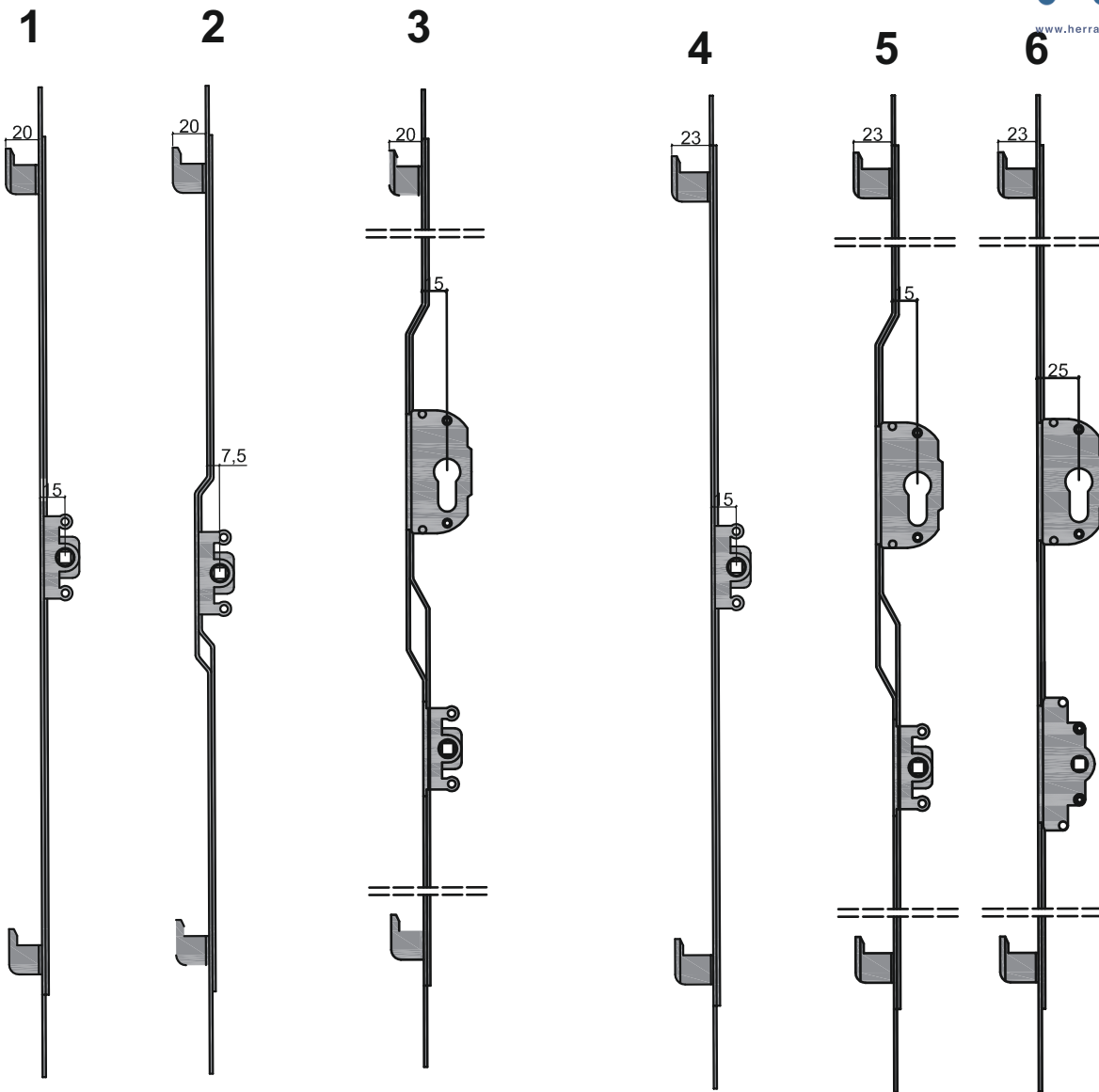



**1 Cremona Entrada 15 Modelo Gancho Mediano**

CODIGO	MEDIDA ALTO	Nº BULONES	COTAS MANILLAS	
20368	600	2	300	20
20369	1.600	3	800	20

**2 Cremona Entrada 7,5 Modelo Gancho Mediano**

CODIGO	MEDIDA ALTO	Nº BULONES	COTAS MANILLAS	
22384	270	1	-	20
18759	600	2	300	20
18761	1.600	3	800	20

**3 Cremona Entrada 15 con llave. Modelo Gancho Mediano**

CODIGO	MEDIDA ALTO	Nº BULONES	COTAS MANILLAS	
20371	1600	3	800	-

**4 Cremona Entrada 15 Modelo Gancho Largo**

CODIGO	MEDIDA ALTO	Nº BULONES	COTAS MANILLAS	
20849	210	1	-	20
18758	600	2	300	20
21830	1.000	2	500	20
18760	1.600	3	800	20

**5 Cremona Entrada 15 con llave. Modelo Gancho Largo**

CODIGO	MEDIDA ALTO	Nº BULONES	COTAS MANILLAS	
19019	1600	3	800	20

**6 Cremona Entrada 25 con llave. Modelo Gancho Largo**

CODIGO	MEDIDA ALTO	Nº BULONES	COTAS MANILLAS	
14367	1600	2	800	20

## Kit micro-ventilación corredera multipunto Entrada 15.

CODIGO	MEDIDA ALTO	Nº BULONES	
20248	600	2	2
20249	1.600	3	2

## Kit micro-ventilación corredera multipunto Entrada 7,5.

CODIGO	MEDIDA ALTO	Nº BULONES	
20250	600	2	2
20251	1.600	3	2

## Plantilla cerradero micro-ventilación corredera

CODIGO	REF.	
20262	-----	2



**NOTA:** Para cantidades inferiores a 20 unidades, los kits se servirán en tubos de 2 unidades por tubo.

## Componentes 2 Kits micro-ventilación corredera multipunto 600 mm.

Cantidad	Artículo
2	Cremona multipunto entrada 15 o 7,5
2	Cerradero micro-ventilación
2	Cerradero estandar INOX
2	Juego de calzos para los cerraderos de 1,2 y 2 mm.
1	Plantilla cerradero micro-ventilación.

## Componentes 2 Kits micro-ventilación corredera multipunto 1.600 mm.

Cantidad	Artículo
2	Cremona multipunto entrada 15 o 7,5
2	Cerradero micro-ventilación
4	Cerradero estandar INOX
4	Juego de calzos para los cerraderos de 1,2 y 2 mm.
1	Plantilla cerradero micro-ventilación.

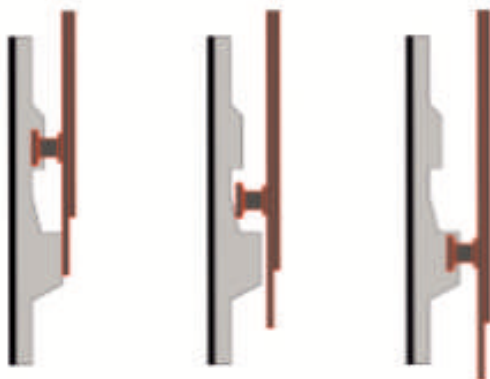
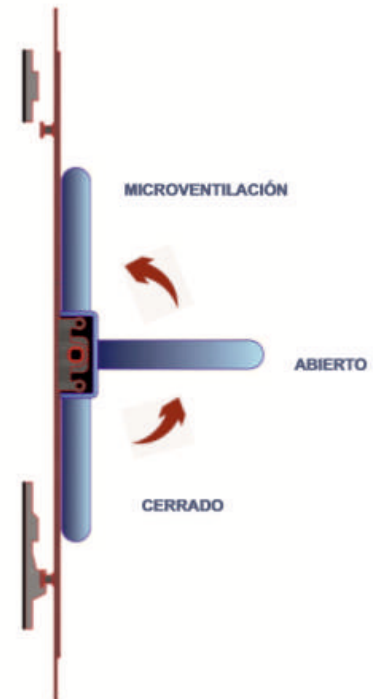

**CERRADO      ABIERTO      MICROVENTILACIÓN**

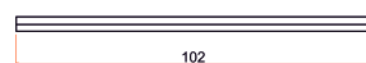
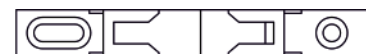

Ensayado según norma UNE-EN 1026:2017. Ventanas y puertas. Permeabilidad al aire.

## Calce de Apoyo Cremona.

CODIGO	REF.	SERIE	
■ 376	140-24-11		100
377	140-24-K1		100
375	120-20-9		100
■ 378	140-24-EZ		100
16929	3602406		100
16897	SM-100	SM-100	100
17732			100
14824			100
■ 17267	0520007	4200 CORTE RECTO CT ANICOLOR	100
■ 17251	0520011	4200 PERIMETRAL CT ANICOLOR	100
17314	0520009	CT87-90P-RP90P	100
17514	3602416	Extrual 75 (estandar)	100
18075	3603006		100
17709	3603111	Minimalista Alcoa, CPT-70 EXTOL	100
16924	3602416	CR-77, EVO 61	100
■ 19049	3602518	Extrual 75 (gancho)	100
19017	2721009	-----	100
19676		-----	100
20338	TEKNICA CR	Teknica Thermic CR	100
21573	TEKNICA PR	Teknica Thermic PR	100
8804		Corte recto	100
25178	3/0014		100
25309	3/0015		100
25310	3/0016		100
25685	53AU14599	Calce Domo 85+	100

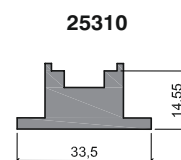
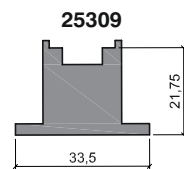
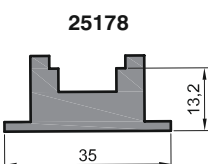
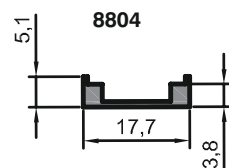
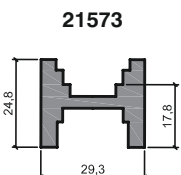
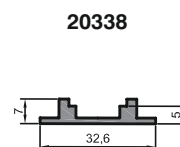
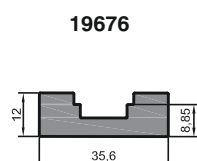
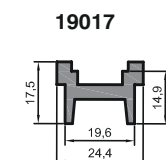
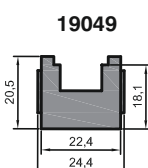
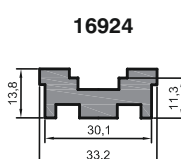
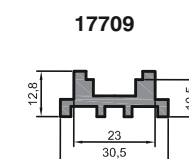
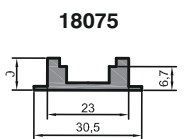
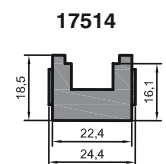
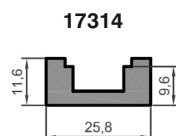
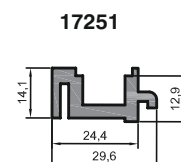
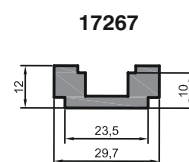
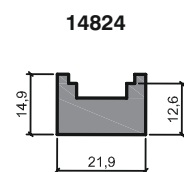
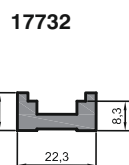
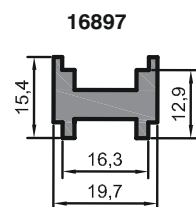
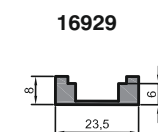
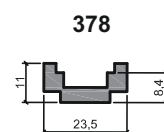
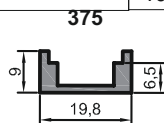
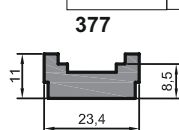
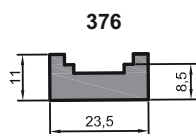

## Cremona multipunto INOXIDABLE MAC.

CODIGO	CODIGO	MEDIDA ALTO	Nº BULONES
21911	MAC2	200	1
21783	MAC6	600	2
21842	MAC16	1.600	3
21843	MAC18	1.800	4

## Cremona multipunto INOXIDABLE con llave MACK.

CODIGO	CODIGO	MEDIDA ALTO	Nº BULONES
21912	MACK6	600	2
21913	MACK16	1.600	3

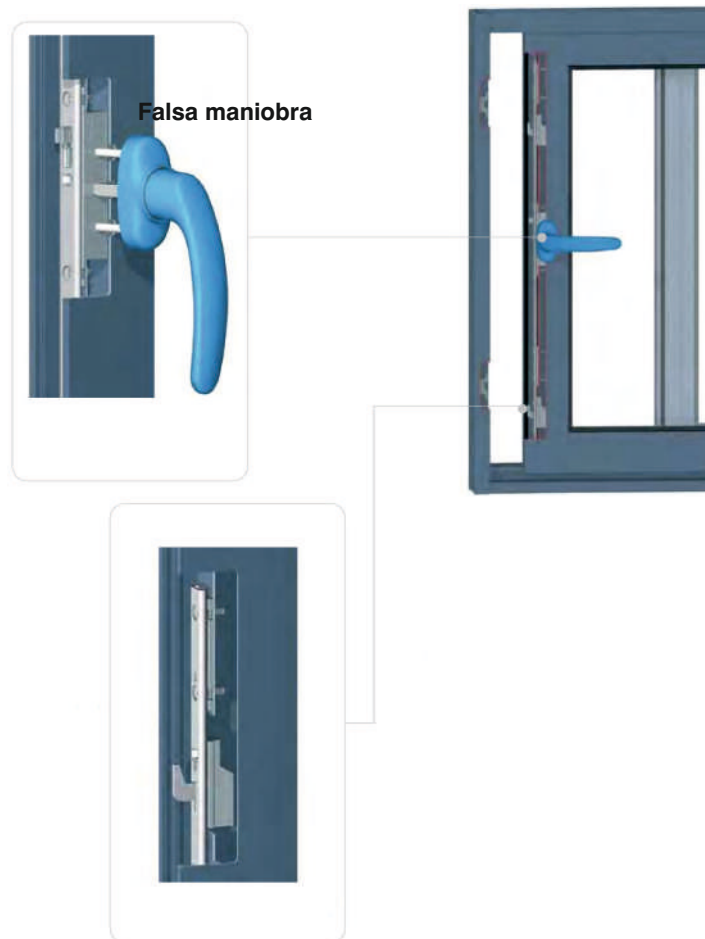
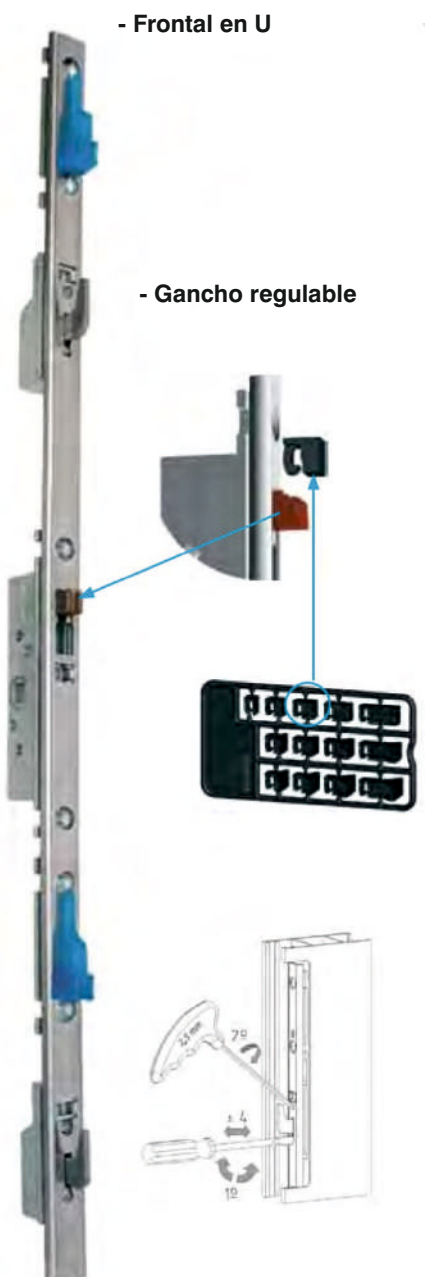

**NOVO**  
NUEVO / NEW  
100% INOX

100% Innox



## Cremona multipunto (acabado inox)

CODIGO	REF.	MEDIDA	PTOS CIERRE	
12366	NI 6000	700	2	40
12713	NI 6000	1400	3	40

## Cierre corredera simple con tornillos sin condensa.

CODIGO	REF.	COLOR	
757	4308	Blanco	50
759	4308	Negro	50

## Cierre corredera simple sin tornillos sin condensa.

CODIGO	REF.	COLOR	
697	4309	Blanco	50
699	4309	Negro	50

## Cierre corredera doble con tornillos con llaves iguales.

CODIGO	REF.	COLOR	
7167	4308C	Blanco	25
7168	4308C	Negro	25

## Cierre corredera simple sin tornillos con llaves iguales.

CODIGO	REF.	COLOR	
4794	4309C	Blanco	50
4795	4309C	Negro	50

## Uña

CODIGO	REF.	
13405	Ni6000	1

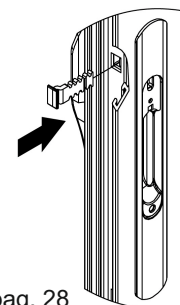

**NOTA:** Para otros colores ver pag. 28.

## Cierre corredera con cremone (pala roscada)

CODIGO	REF.	COLOR	
■ 13365	4220 ESPECIAL	Blanco	12
■ 11055	4220 ESPECIAL	Negro	12
2685	Pernio 11mm		40



## Cierre de 1 punto o 3 puntos con cremona modelo TRADICIONAL

CODIGO	REF.	COLOR	
571	4220 1 punto	Blanco	6
572	4220 1 punto	Negro	6
573	4220 3 puntos	Blanco	6
574	4220 3 puntos	Negro	6

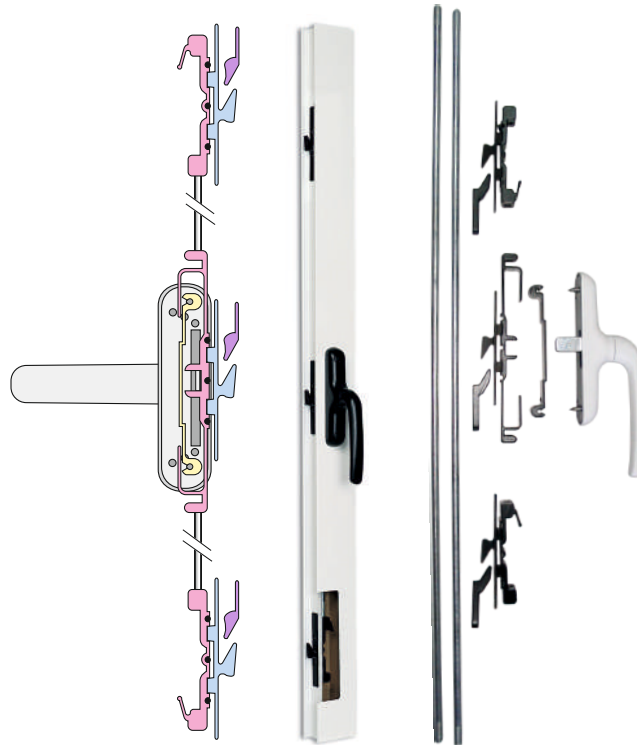

## Contracierres

CODIGO	REF.	SERIE	
15791	----	----	-
5476	4221	s/4221	50
5589	2180.87	s/800I	-
6337	2180.109	s/Marina	-

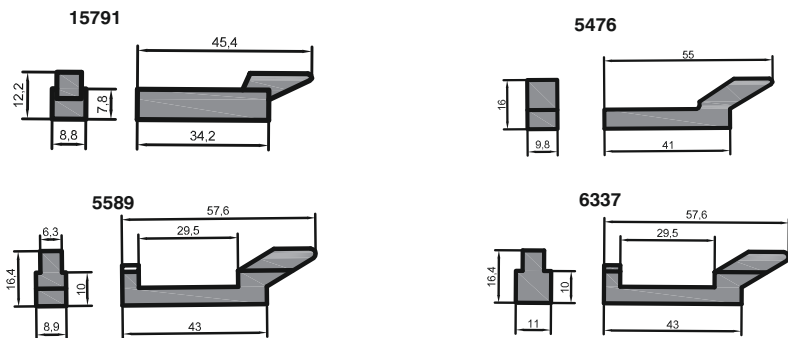

## Cierre monopunto para corte recto.

CODIGO	REF.	
6635	3812000	-

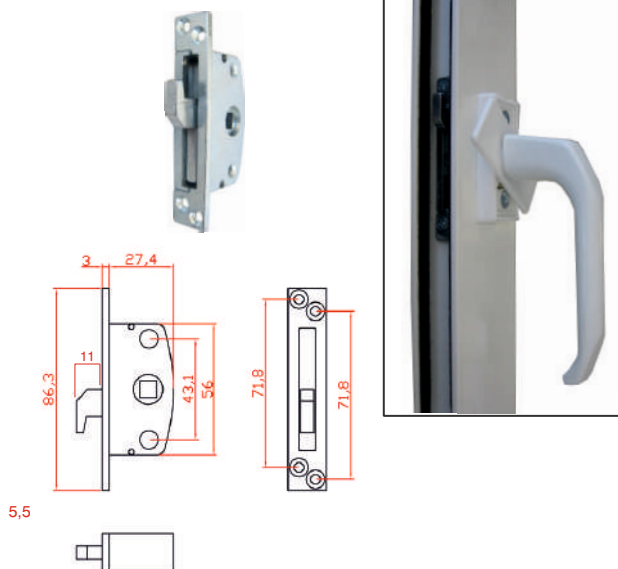

## Cremona 104 doble o simple.

CODIGO	REF.	COLOR	
1051	104 SL (doble)	Blanco	10
1053	104 SL (doble)	Negro	10
1680	107 SL (2º punto cierre)		50

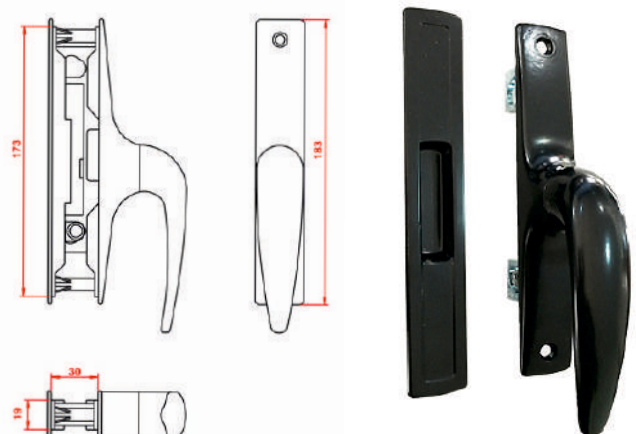

**NOTA:** Disponemos de otras medidas de gancho. Consultar con departamento comercial.

## Manilla Plana Embutida.

CODIGO	REF.	COLOR	
7082	3030	Blanco	60
7137	3030	Negro	60
6790	6398.1 grande	Blanco	20
6791	6398.1 grande	Negro	20
21396	6398.1 grande	Plata	20
24694	6398.1 grande	Lac Inox	20

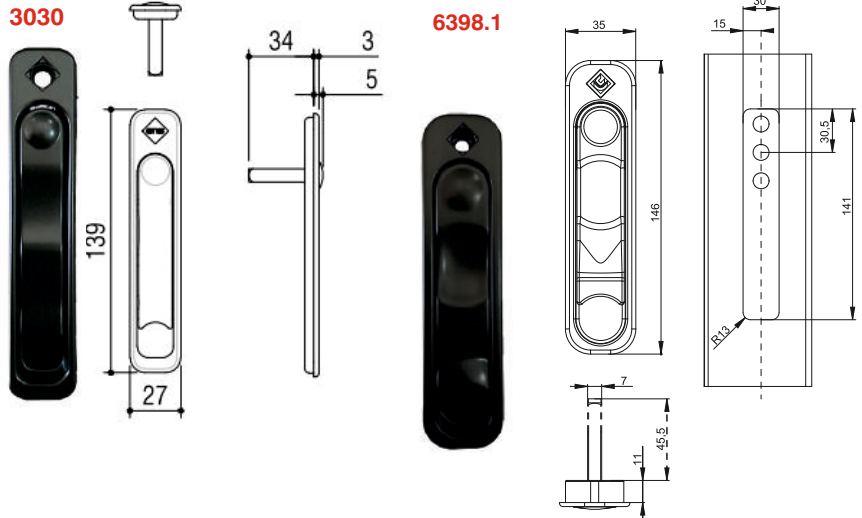

## Manilla oculta 180°/90° multifunción eje 21mm.

CODIGO	REF.	COLOR	
25207	6397.19	Blanco	20
25208	6397.19	Negro	20
25211	6397.19	Plata	20
25212	6397.19	Lac Inox	20

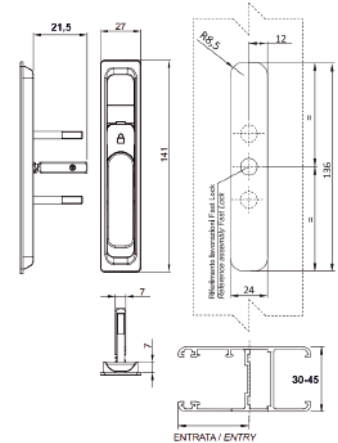

**NOTA:** La apertura del multipunto se consigue con la palanca de la manilla en posición de 180°, mientras el giro del eje hace los 90° que necesita el multipunto, de esta forma evitamos roturas innecesaria de la palanca.

## Tirador FAST LOCK (clipado o atornillado a manilla multifunción)

CODIGO	REF.	COLOR	
9494	6397.11	Blanco	20
9495	6397.11	Negro	20
9889	6397.11	Lac Plata	20
9989	6397.11	Lac Inox	20
14575	6397.10	Blanco	20
14576	6397.10	Negro	20
14577	6397.10	Lac Plata	20
14578	6397.10	Lac Inox	20

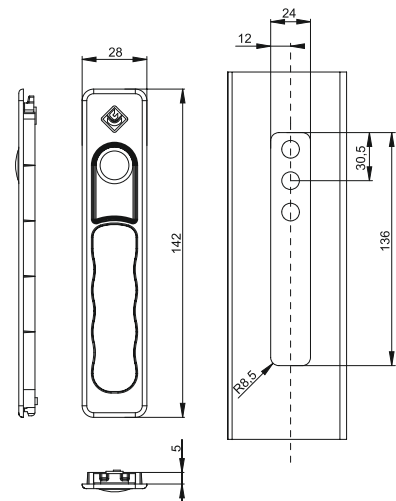

**NOTA:** Para la manilla 6397.19 utilizar el tirador 6397.10

### 6397.10 (clipado)

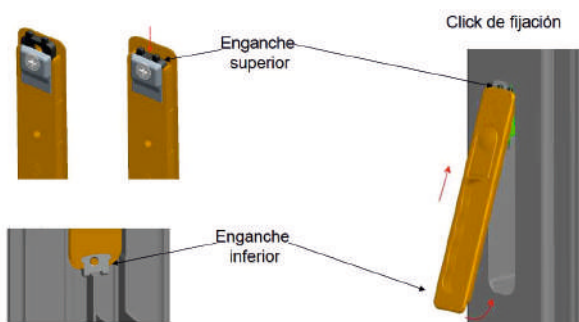

### 6397.11 (atornillado a manilla multifunción)

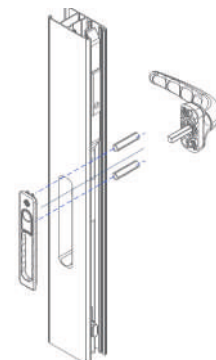



## Cierre multipunto EDGE ventana (165mm)

CODIGO	MEDIDA	COLOR	MANO	
■ 11133	165mm	Blanco	Derecha	20
■ 12636	165mm	Blanco	Izquierda	20
■ 10049	165mm	Negro	Derecha	20
■ 10651	165mm	Negro	Izquierda	20
13643	165mm	Plata	Derecha	20
13620	165mm	Plata	Izquierda	20
13650	165mm	Inox	Derecha	20
13651	165mm	Inox	Izquierda	20

## Cierre multipunto EDGE balconera (220mm)

CODIGO	MEDIDA	COLOR	MANO	
■ 13788	210mm	Blanco	Derecha	20
■ 13690	210mm	Blanco	Izquierda	20
■ 13657	210mm	Negro	Derecha	20
■ 13679	210mm	Negro	Izquierda	20
13805	210mm	Plata	Derecha	20
13806	210mm	Plata	Izquierda	20
13844	210mm	Inox	Derecha	20
13854	210mm	Inox	Izquierda	20

## Tirador exterior EDGE ventana

CODIGO	MEDIDA	COLOR	
■ 11126	165mm	Blanco	20
■ 11127	165mm	Negro	20
11336	165mm	Plata	20
11235	165mm	Inox	20

## Tirador exterior EDGE balconera

CODIGO	MEDIDA	COLOR	
■ 10039	210mm	Blanco	20
■ 10711	210mm	Negro	20
11100	210mm	Plata	20
10712	210mm	Inox	20

**NOTA:** El cierre de derecha va colocado en la hoja de la izquierda y viceversa.



## Tirador hoja pasiva EDGE ventana

CODIGO	MEDIDA	COLOR	
■ 23964	165mm	Blanco	20
■ 23965	165mm	Negro	20
23967	165mm	Plata	20
23966	165mm	Inox	20

**NOTA:** Para el tirador de hoja pasiva no es necesario colocar el cierre interior.

## Eje EDGE para manilla interior / exterior

CODIGO	MEDIDA	
23492	130mm	50

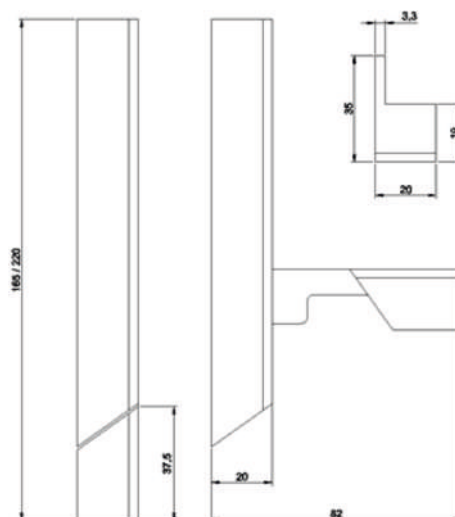



## Cierre multipunto WING LINE 50

CODIGO	MEDIDA	COLOR	
25312	160mm	Blanco	20
25313	160mm	Negro	20
25314	160mm	Plata	20
25315	160mm	Inox	20

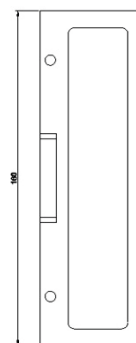

## Tirador exterior WING LINE 50

CODIGO	MEDIDA	COLOR	
25316	160mm	Blanco	20
25317	160mm	Negro	20
25318	160mm	Plata	20
25319	160mm	Inox	20



## Manilla Multifuncion en acero inoxidable con base rectangular. (4 posiciones)

CODIGO	REF.	
6456	10927/45	-
2512	20040	-

10927/45

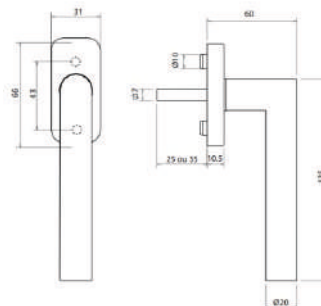

20040

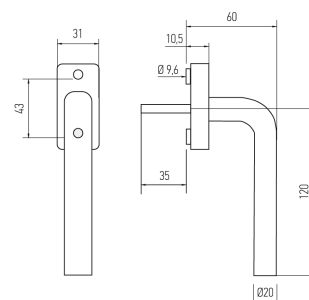

**NOTA:** Para hacer la manilla doble utilizar el tornillo y la tuerca pag. 105

## Manilla Multifuncion en acero inoxidable con llave

CODIGO	REF.	
11943	11417	-

**NOTA:** Para hacer la manilla doble utilizar el tornillo y la tuerca pag. 105



## Cierre central para ventanas corredera con o sin llave.

CODIGO	REF.	COLOR	
14895	11545 llaves iguales	Blanco	15
14896	11545 llaves iguales	Negro	15
14906	11545 llaves iguales	Lac Plata	15

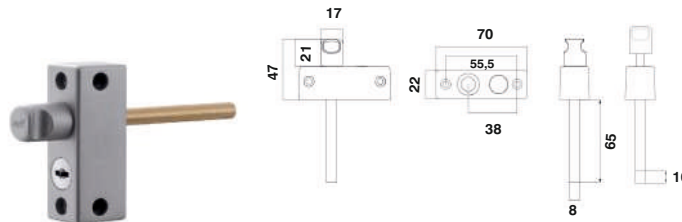

## Cierre central con pulsador .

CODIGO	REF.	COLOR		
12893	3075	Blanco	con pulsador	10
14047	3075	Negro		10
13325	3076	Blanco	con llaves iguales	10
13326	3076	Negro		10

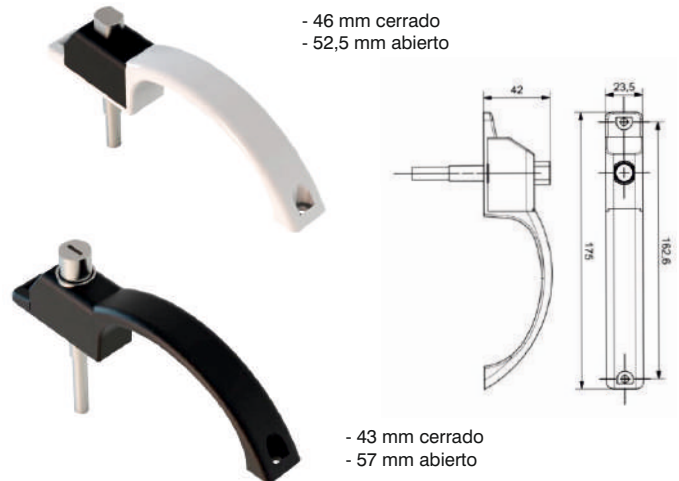

## Cierre central para ventanas corredera con llave .

CODIGO	REF.	COLOR	
16931	200466 llaves iguales	Blanco	10
16932	200466 llaves iguales	Negro	10
16952	Pernio 24mm		50

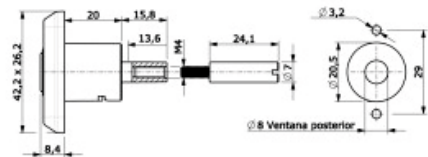

## Cierre central para ventanas corredera con pomo.

CODIGO	REF.	COLOR	
17001	200466 con pomo	Blanco	10
17002	200466 con pomo	Negro	10
16952	Pernio 24mm		50



Medidas (con prolongador):  
 - abierto: 26mm  
 - cerrado: 39mm

## Roseta quita y pon.

CODIGO	REF.	COLOR		
1372	6-46231-00-0-7	Blanco	Plástico	10
1371	6-46231-00-0-5	Negro		10



CODIGO	REF.	COLOR		
13630	6-24913-00-0-7	Blanco	Metálico	1
15381	6-24913-00-0-5	Negro		1



## Llave quita y pon.

CODIGO	REF.	
2501	E-18331-PR-0-0	10



## Manilla Dirigent quita y pon blanca.

CODIGO	REF.	
13152	8-00694-50-0-7	1

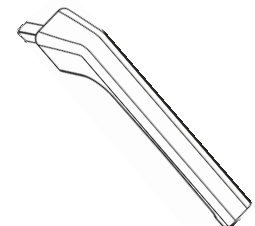

## Tope GV-909

CODIGO	REF.	COLOR	
3616	TOPE GV909	Blanco	1
3617	TOPE GV909	Negro	1
6672	TOPE GV909	Lac plata	1

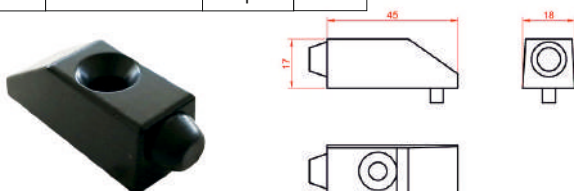

## Tirador exterior pequeño.

CODIGO	COLOR	
9864	Blanco	100
9865	Negro	100
9866	Lac Plata	100
9867	Lac Inox	100

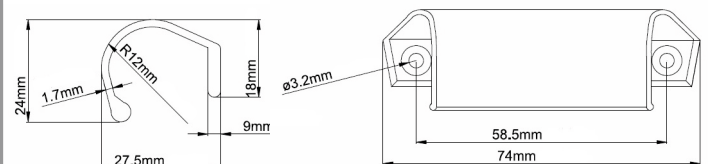

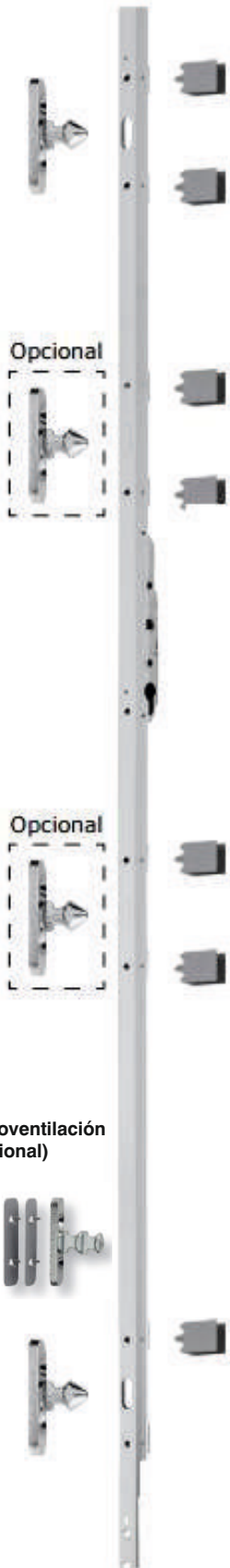

Opcional

Opcional

Microventilación (opcional)

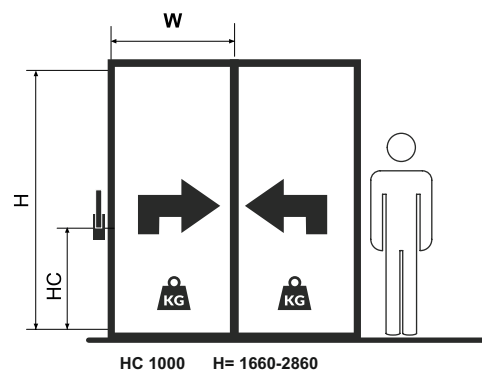
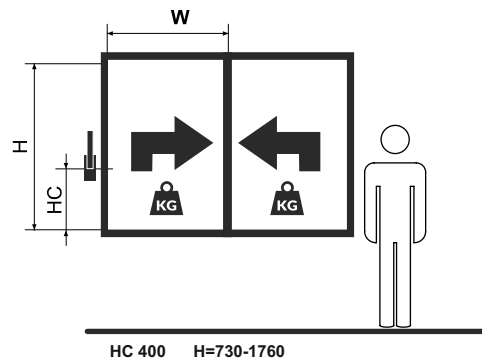

<b>KG</b>	200	630-2200	
<b>W</b>	Max		
<b>KG</b>	300	1200-3385	
<b>W</b>	Max		
<b>KG</b>	300	720-3385	
<b>W</b>	Max		
<b>KG</b>	400	1200-3385	
<b>W</b>	Max		



Carros suplementarios

CODIGO	REF.		
19262	229491	300 kgs	10
9685	215138	400 kgs	10

Varilla conexión

CODIGO	REF.	
7134	359638	1

**Nota:** Disponemos de herraje para bastidores individuales hasta **400 kg**, y para todas las series del mercado. (Más información en nuestra web: [www.herrajesuropeos.com](http://www.herrajesuropeos.com))

2

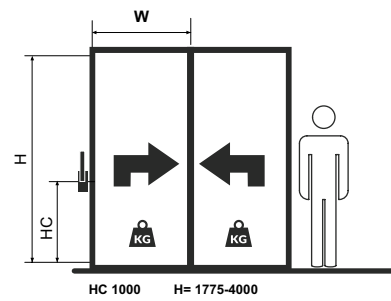
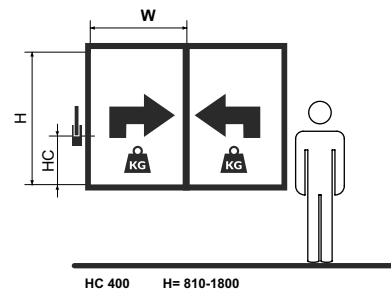

250 Max	730-3400	
<b>W</b> ≥		
400 Max	1330-3800	
<b>W</b> ≥		
330 Max	730-3400	
<b>W</b> ≥		
440 Max	1330-3800	
<b>W</b> ≥		

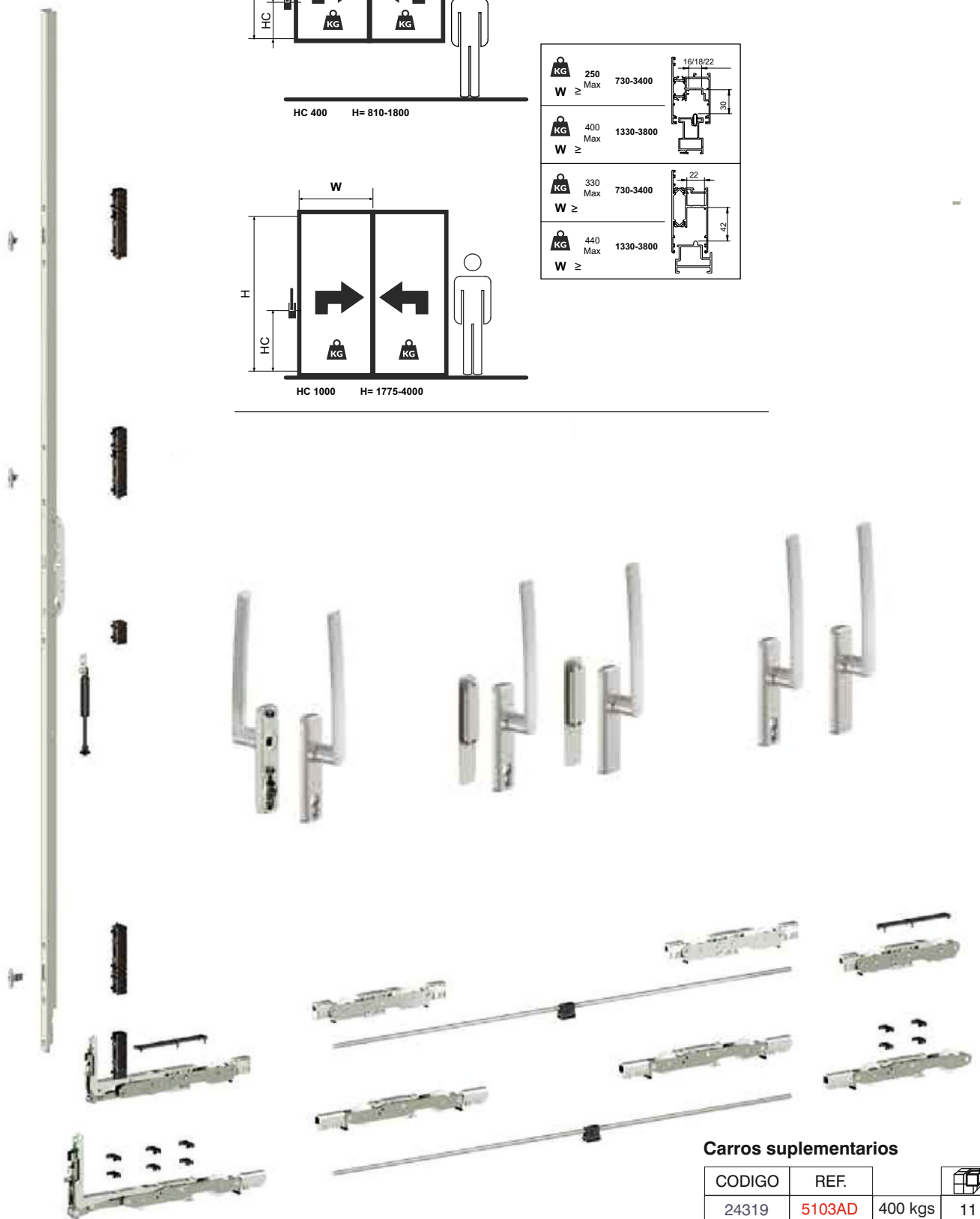

**Carros suplementarios**

CODIGO	REF.		
24319	5103AD	400 kgs	11
24320	5101AD	440 kgs	10

## Accesorios correderas elevables

CODIGO	REF.	DESCRIPION	
8584	20380	Cremona multipunto 1600 E-30	1
5775	G-18250	Cremona multipunto llave 1600 E-25	10
318	13880	Cerradero standar marco perimetral	100
16280	TRK	Cerradero marco abierto	1
20236	1700P/35	Calce multipunto elevable 300 kgs	1

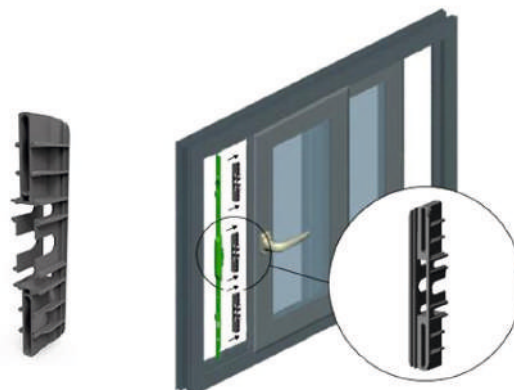

## Rueda corredera para elevables pequeñas en linea (elevable de 200 kgs)

CODIGO	REF.	KGS por rueda	
3170	C00363PLA (tandem)	50	1
5416	GU-937	120	1



## Rueda corredera para elevables grandes en linea (elevables de 300 kgs)

CODIGO	REF.	KGS por rueda	
16760	600HCS - TANDEM	150	30
16761	600 HCS - SIMPLE	75	30



CODIGO	DESCRIPION	
9304	Kit tacos fijación para elevable 300kgs (4 piezas)	10

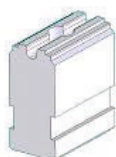

## Tope elevable

CODIGO	REF.	COLOR	
10316	K-12024-00-0-7	Blanco	1
3618	K-12024-00-0-6	Negro	1



3

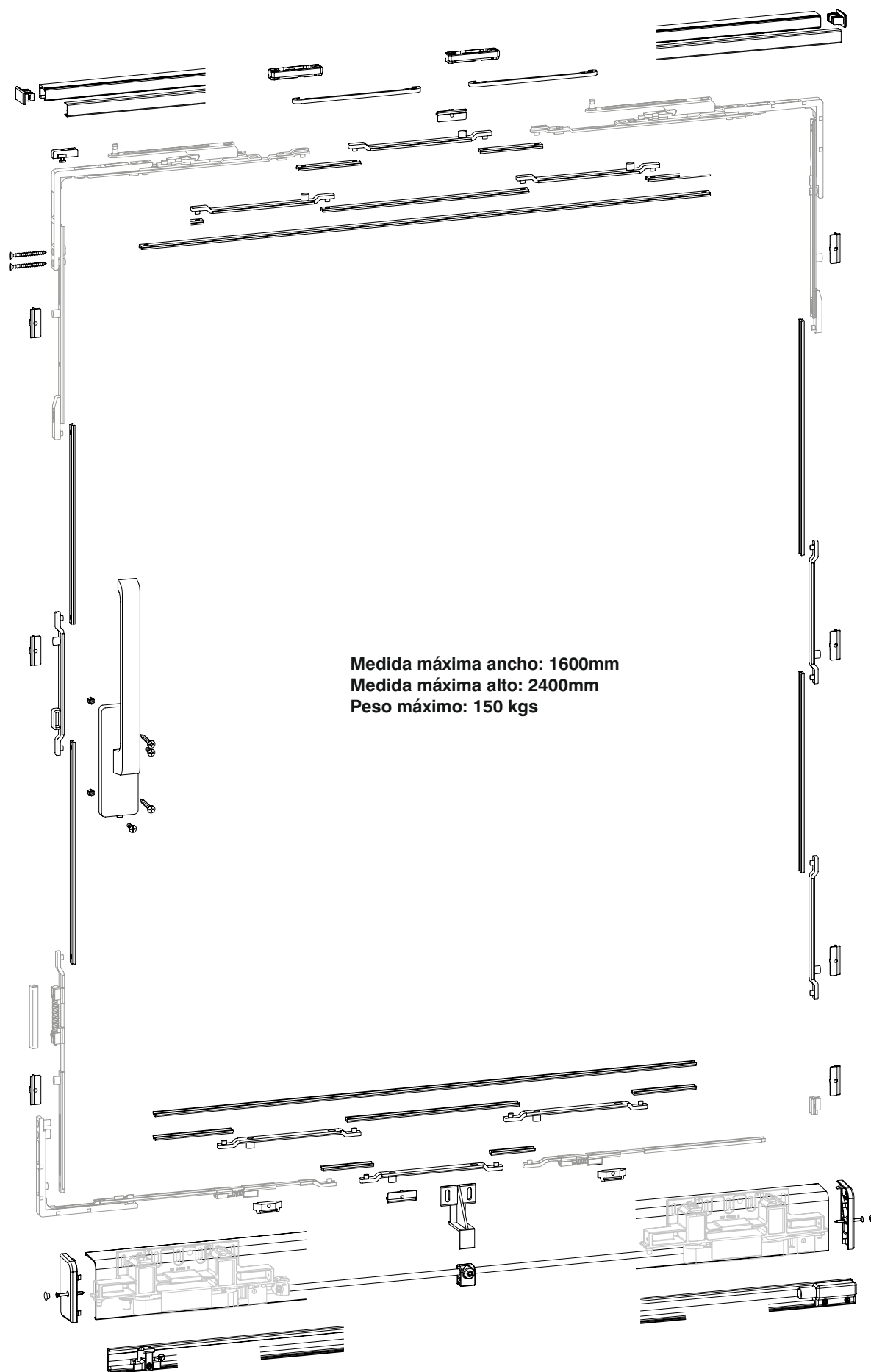

Medida máxima ancho: 1600mm  
Medida máxima alto: 2400mm  
Peso máximo: 150 kgs

**NOTA:** Disponible también para Canal 16.

**Esquemas posibles:**

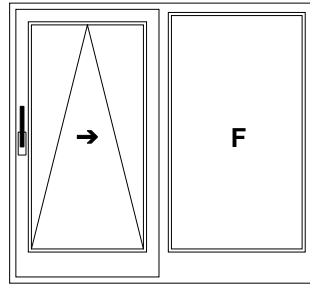

**Esquema A – con travesaño central**  
1 hoja corredera, 1 hoja fija  
Dibujó: montaje mano izquierda

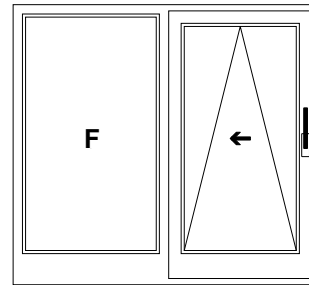

**Esquema A – con travesaño central**  
1 hoja corredera, 1 hoja fija  
Dibujó: montaje mano derecha

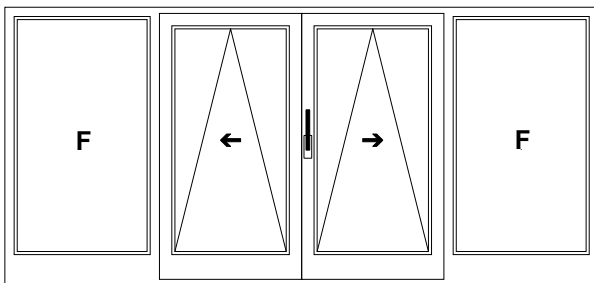

**Esquema C – con travesaños centrales**  
2 hojas correderas, 2 hojas fijas  
Dibujó: Hoja de primera apertura con posición de manilla izquierda

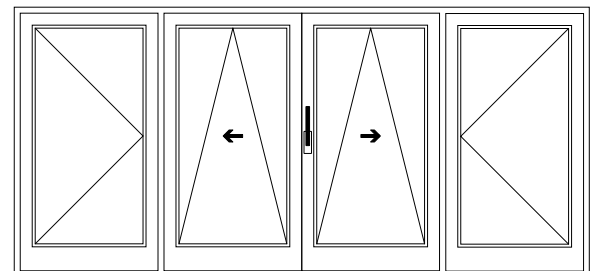

**Esquema C – con travesaños centrales**  
2 hojas correderas, 2 hojas practicables  
Dibujó: Hoja de primera apertura con posición de manilla izquierda

**Dimensiones de montaje Canal Europeo:**

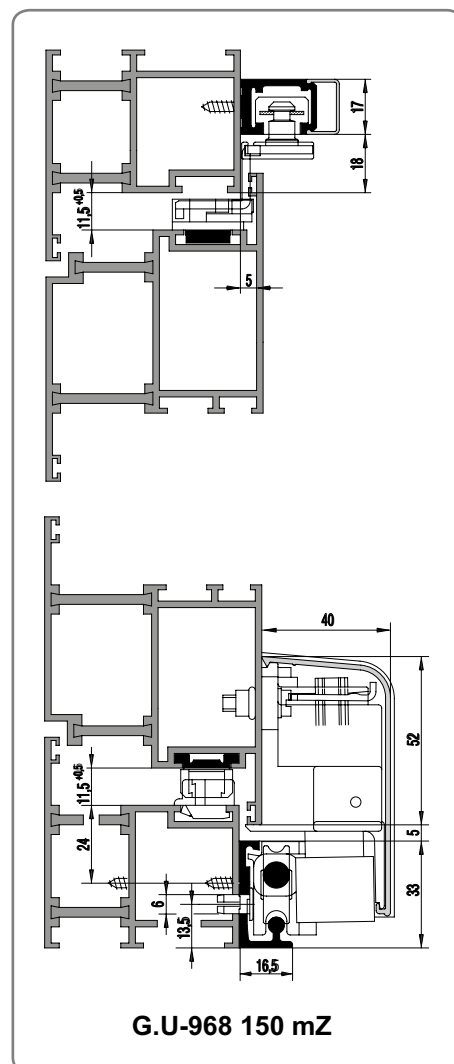
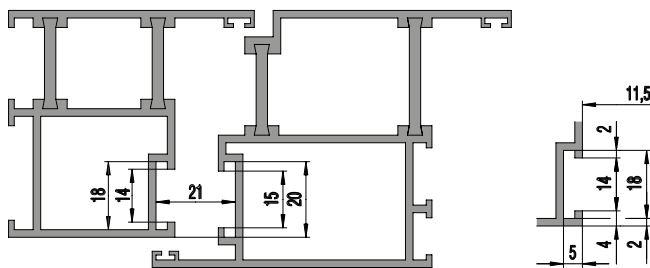

**Nota:** Utilizar perfil de puerta para marco y hoja.

**Nota:** También disponemos de herraje corredera-paralela. Recomendada especialmente para hoteles.



DETALLE  
MICROVENTILACIÓN



4

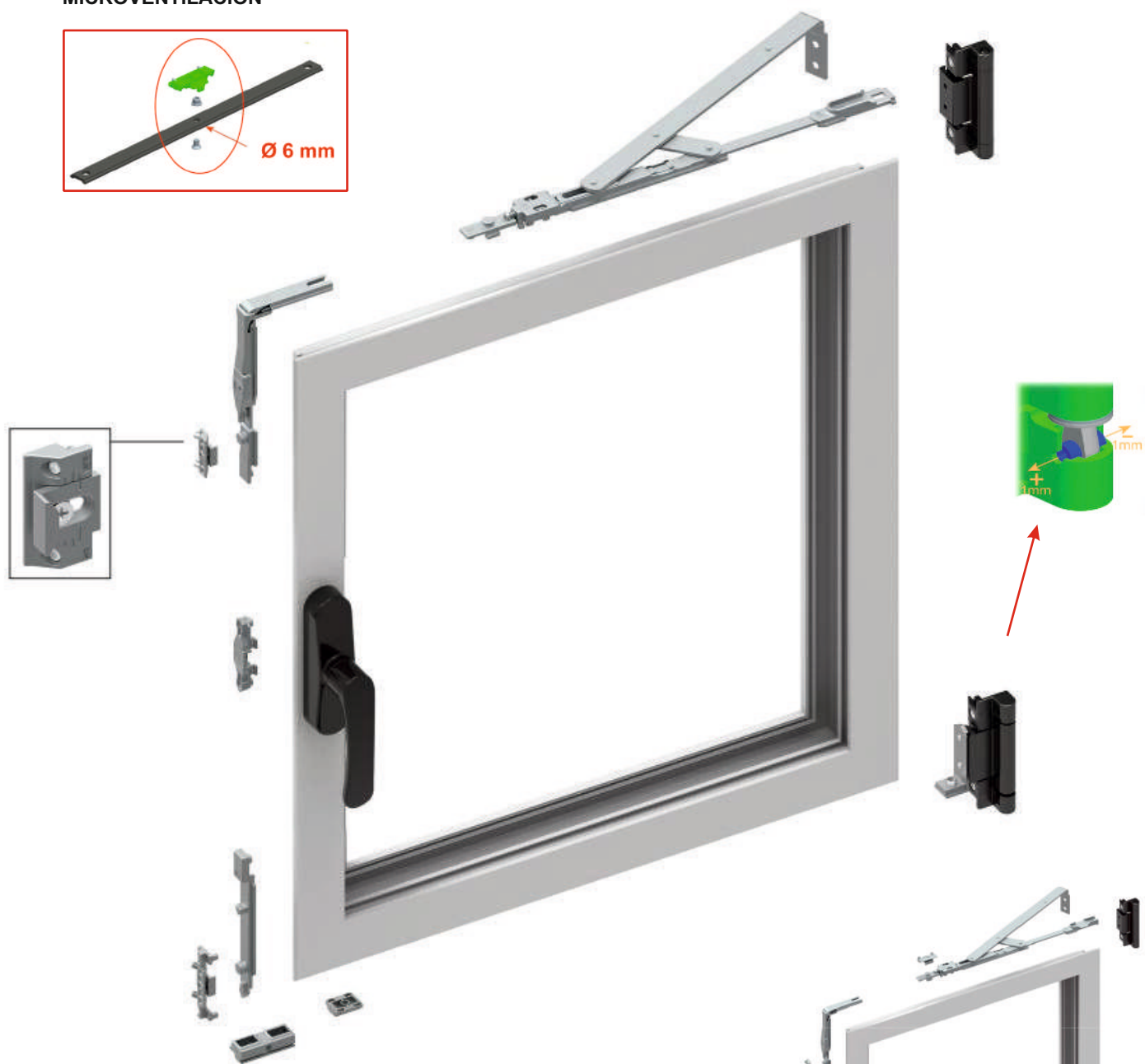

**120 KG**

**Altura mínima: 450 mm**

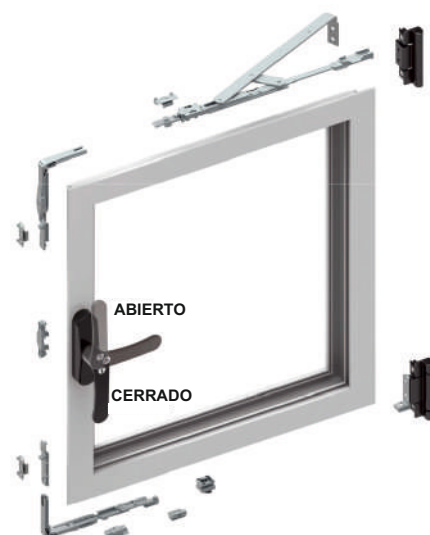

Oscilo con maniobra lógica.





7101 LINEA TRADICIONAL



LINEA CUADRO



9592 LINEA PRESTIGE

### Oscilo 100 7000 con cremona 7101

CODIGO	REF.	MEDIDA	COLOR
20316	100 7000	340/450	Blanco
20317	100 7000	340/450	Negro
■ 5881	100 7000	380/550	Blanco
■ 5882	100 7000	380/550	Negro
■ 5883	100 7000	550/900	Blanco
■ 5884	100 7000	550/900	Negro
■ 5665	100 7000	900/1200	Blanco
■ 5874	100 7000	900/1200	Negro

### Oscilo 5100 con cremona CUADRO

CODIGO	REF.	MEDIDA	COLOR	LLAVE
22128	5100	340/450	Blanco	23661
22132	5100	340/450	Negro	23662
22136	5100	340/450	Lac Plata	23663
22140	5100	340/450	Lac Inox	23664
■ 22129	5100	380/550	Blanco	23611
■ 22133	5100	380/550	Negro	23651
■ 22137	5100	380/550	Lac Plata	23655
■ 22141	5100	380/550	Lac Inox	23658
■ 22130	5100	550/900	Blanco	23650
■ 22134	5100	550/900	Negro	23652
■ 22138	5100	550/900	Lac Plata	23656
■ 22142	5100	550/900	Lac Inox	23659
■ 22131	5100	900/1200	Blanco	23653
■ 22135	5100	900/1200	Negro	23654
■ 22139	5100	900/1200	Lac Plata	23657
■ 22143	5100	900/1200	Lac Inox	23660

### Oscilo 9592 AL Logica con llave

CODIGO	REF.	MEDIDA	COLOR
19337	9592	380/550	Blanco
19348	9592	380/550	Negro
19338	9592	550/900	Blanco
19350	9592	550/900	Negro
19339	9592	900/1200	Blanco
19349	9592	900/1200	Negro

4



**NOTA:** Para ventanas con medidas de 1200 a 1500 utilizar compas suplementario CODIGO 6019 con el compás 550/900.

### Bisagra 2ª hoja

CODIGO	REF.	COLOR	
■ 5678	100 7000	Blanco	6
■ 5679	100 7000	Negro	6
■ 7355	100 7000	Lac Plata	6
■ 6713	100 7000	Lac Inox	6



### Bisagra 2ª hoja regulable (con falso compás)

CODIGO	REF.	COLOR	
■ 7953	9210	Blanco	6
■ 7954	9210	Negro	6



### Punto cierre oculto

CODIGO	REF.	
■ 8044	40809	50



### Ángulo extra de reenvío

CODIGO	REF.	POSICION	
■ 4022	100 7000	Vertical	12
■ 4023	100 7000	Horizontal	10



### Juego pasadores 2ª hoja de zamak.

CODIGO	REF.	
■ 14239	9204	12

### Juego pasadores económico

CODIGO	REF.	
6018	9203	24

### Pasador de palanca

CODIGO	REF.	
■ 17484	9212	6



### Pasador logica bidireccional CE 2ª hoja metalico

CODIGO	REF.	
19397	9213	24

9203 9204 9213

### Kit microventilacion oscilo.

CODIGO	REF.	
■ 7349	33528	150



**Manilla Multifunción Linea TRADICIONAL.**

CODIGO	REF.	COLOR	
4693	9645 grande	Blanco	30
4694	9645 grande	Negro	30
2518	4930 pequeña	Blanco	24
2519	4930 pequeña	Negro	24

9645

4930

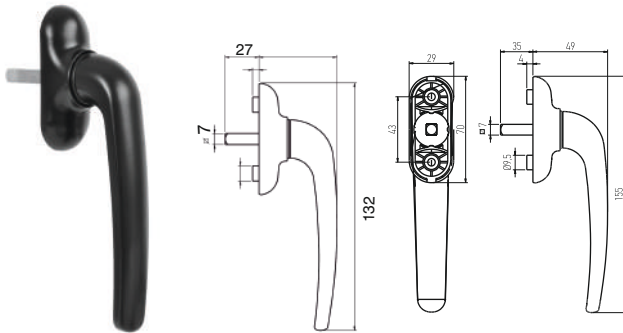

**NOTA:** Para hacer la manilla doble utilizar el tornillo y la tuerca pag. 105.

**Manilla Multifuncion Acodada**

CODIGO	REF.	COLOR	MANO	
4751	9640	Blanco	Derecha	15
4752	9640		Izquierda	15
4747	9640	Negro	Derecha	15
4748	9640		Izquierda	15

Derecha

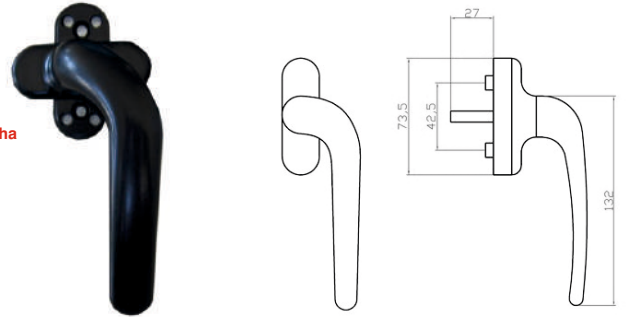

**NOTA:** La mano de la manilla es según el desplazamiento de la manilla y no de la posición de la manilla en la ventana.

**NOTA:** Para hacer la manilla doble utilizar el tornillo y la tuerca pag. 105.

**Suplemento manilla (espesor 4mm).**

CODIGO	COLOR	
10363	Blanco	1
10364	Negro	1



**Cremona interior. Linea TRADICIONAL.**

CODIGO	REF.	COLOR	
1023	7100 grande	Blanco	12
1024	7100 grande	Negro	12
1006	6000 pequeña	Blanco	12
1007	6000 pequeña	Negro	12

7100

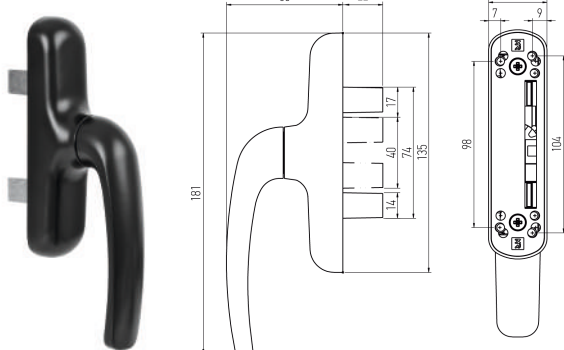

6000

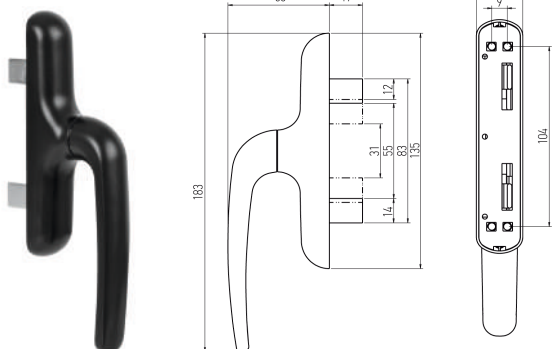

**Cremona 2 palas atornilladas al frontal (series 4000/6000)**

CODIGO	REF.	COLOR	
1009	6101	Blanco	12
1010	6101	Negro	12

6101

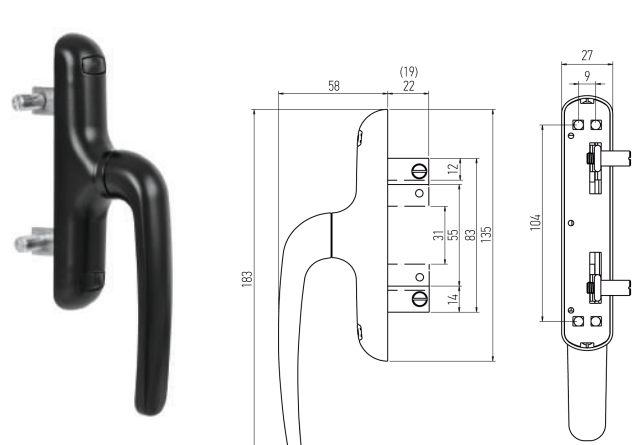

Cremona baja 4 hojas.

CODIGO	REF.	COLOR	
3069	6303	Blanco	12
1827	6303	Negro	12
1018	6302	Blanco	12
1019	6302	Negro	12



6303

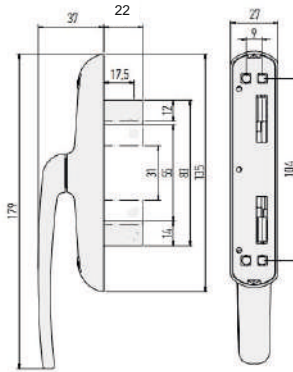

6302 [www.herrajesuropeos.com](http://www.herrajesuropeos.com)

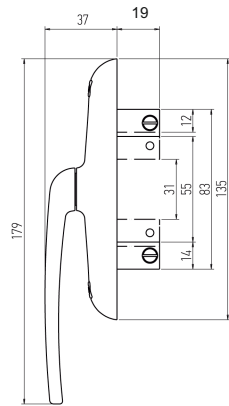

**NOTA:** La cremona 6302 lleva agujeros para la transmisión de pala.

4

Manilla recuperable. (Jgo). Escudo giratorio

CODIGO	REF.	COLOR	
2539	7200	Blanco	12
2540	7200	Negro	12

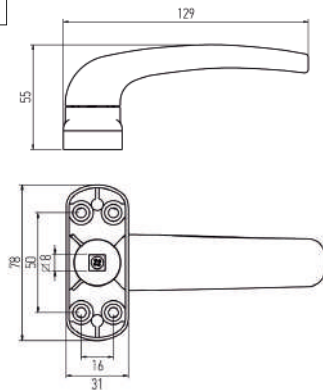

Manilla Recuperable. Linea TRADICIONAL (Jgo). Escudo superpuesto

CODIGO	REF.	COLOR	
2521	4936	Blanco	12
2522	4936	Negro	12

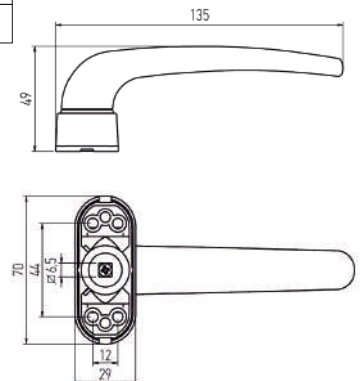

**NOTA:** Eje desplazado 8mm x 100mm código 1359  
Eje recto 8mm x 100mm código 1361

Cierre presión

CODIGO	REF.	COLOR	MANO	
577	4940	Blanco	Derecha	
581	4940		Izquierda	
579	4940	Negro	Derecha	
582	4940		Izquierda	
583	4941	Blanco	Derecha	
7778	4941		Izquierda	
584	4941	Negro	Derecha	
6922	4941		Izquierda	



Manilla con escudo. (Jgo)

CODIGO	REF.	COLOR	
2172	1515	Blanco	10
2174	1515	Negro	10

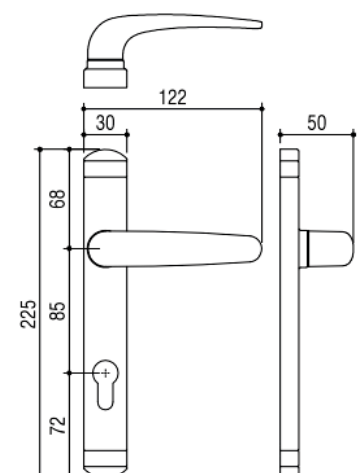

Suplemento cierre

CODIGO	ALTURA	COLOR
6390	3 MM	Blanco
6391	3 MM	Negro
6393	5 MM	Blanco
6392	5 MM	Negro

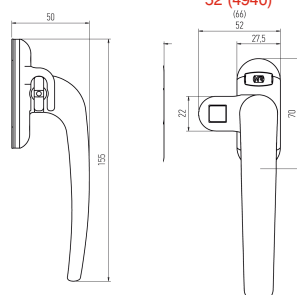

**Manilla Multifuncion Linea CUADRO**

CODIGO	REF.	COLOR
22289	5160	Blanco
22290	5160	Negro
22291	5160	Lac Pata
22292	5160	Lac Inox
22322	5160 C/C	Blanco
22323	5160 C/C	Negro
22324	5160 C/C	Lac Plata
22325	5160 C/C	Lac Inox

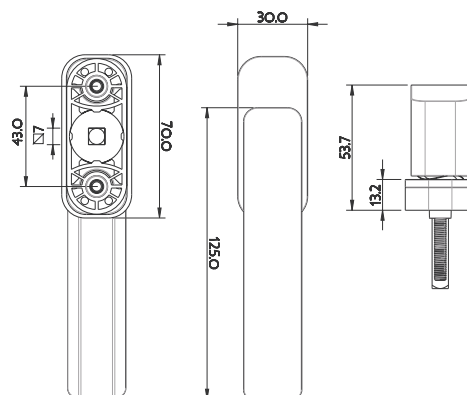

**NOTA:** Para hacer la manilla doble utilizar el tornillo y la tuerca pag. 105.

**Manilla acodada. Linea CUADRO**

CODIGO	REF.	COLOR	MANO
22277	5185	Blanco	Derecha
22274	5180	Blanco	Izquierda
22271	5185	Negro	Derecha
22275	5180	Negro	Izquierda
22272	5185	Lac Plata	Derecha
22276	5180	Lac Plata	Izquierda
22273	5185	Lac Inox	Derecha
22278	5180	Lac Inox	Izquierda

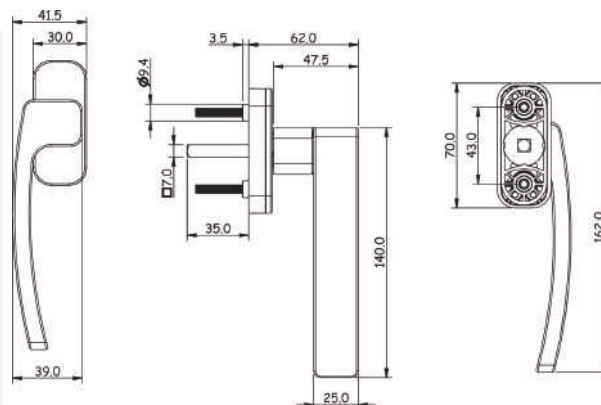

**Manilla acodada con llave. Linea CUADRO**

CODIGO	REF.	COLOR	MANO
23352	5185C/C	Blanco	Derecha
23348	5180C/C	Blanco	Izquierda
23353	5185C/C	Negro	Derecha
23349	5180C/C	Negro	Izquierda
23354	5185C/C	Lac Plata	Derecha
23350	5180C/C	Lac Plata	Izquierda
23355	5185C/C	Lac Inox	Derecha
23351	5180C/C	Lac Inox	Izquierda



5180 C/C  
5185 C/C

**NOTA:** La mano de la manilla es según el desplazamiento de la manilla y no de la posición de la manilla en la ventana.

**Manilla Multifunción larga Linea CUADRO**

CODIGO	REF.	COLOR
24558	5165 larga	Blanco
24559	5165 larga	Negro
24737	5165 larga	Lac plata
24738	5165 larga	Lac inox

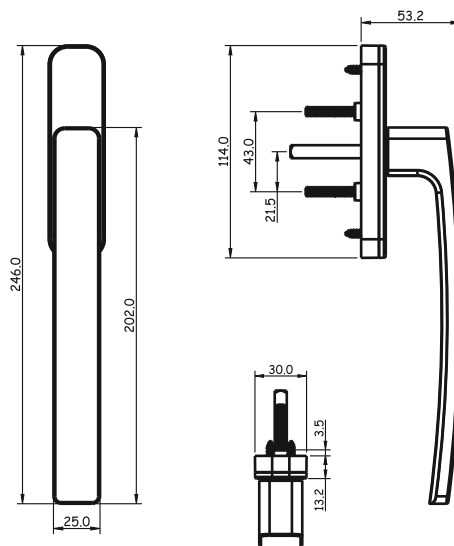

## Cremona apertura interior 2 palas- Linea CUADRO.

CODIGO	REF.	COLOR
22309	5110	Blanco
22310	5110	Negro
22311	5110	Lac Plata
22312	5110	Lac Inox

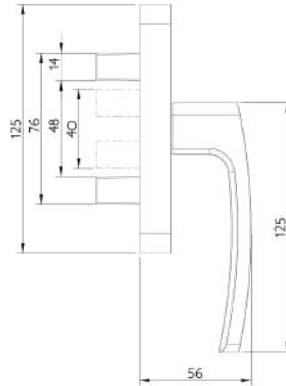

5110

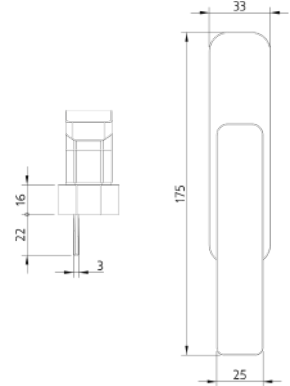

## Cremona apertura interior 2 palas estrecha Linea CUADRO.

CODIGO	REF.	COLOR
24550	5260	Blanco
24551	5260	Negro

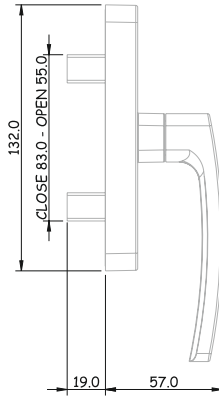

5260

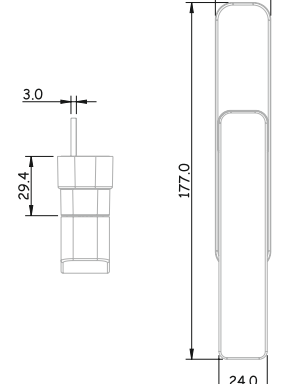

## Cremona apertura interior 2 palas con llave - Linea CUADRO.

CODIGO	REF.	COLOR
22318	5110 C/C	Blanco
22319	5110 C/C	Negro
22320	5110 C/C	Lac Plata
22321	5110 C/C	Lac Inox

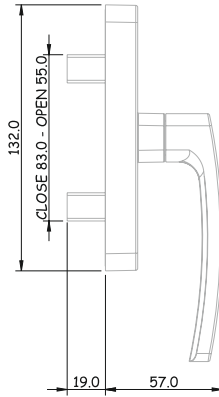

5260

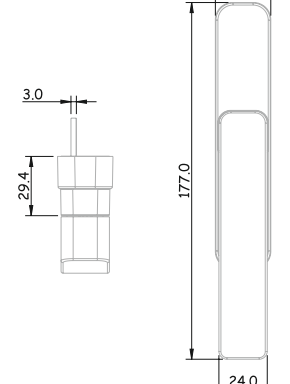

## Palas cremona IZQUIERDA (solo para cremona 5110)

CODIGO	REF.	12
23293	5110	12

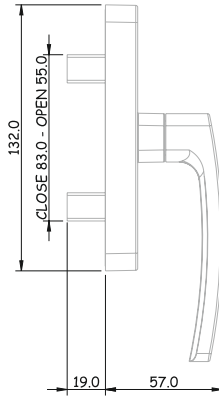

5260

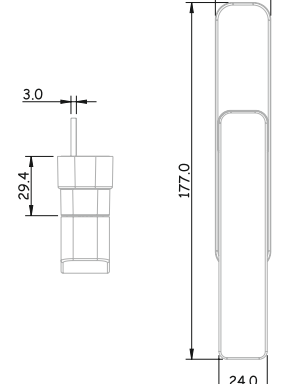

## Cremona apertura exterior 2 palas- Linea CUADRO.

CODIGO	REF.	COLOR
22242	5216	Blanco
22243	5216	Negro
22244	5216	Lac Plata
22245	5216	Lac Inox

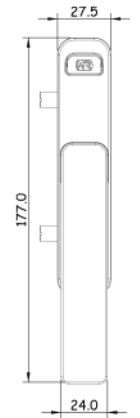
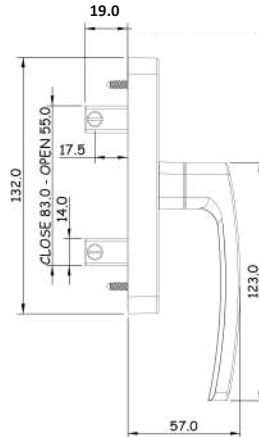

## Cremona apertura exterior 2 palas con llave- Linea CUADRO.

CODIGO	REF.	COLOR
22326	5216 C/C	Blanco
22327	5216 C/C	Negro
22328	5216 C/C	Lac Plata
22329	5216 C/C	Lac Inox

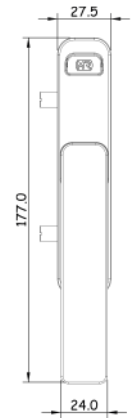
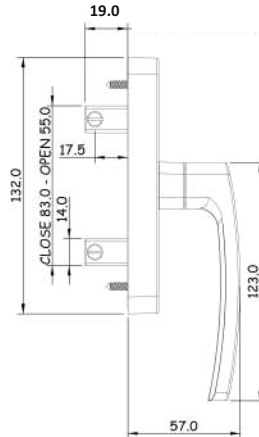

## Cremona plana apertura exterior 2 palas Linea CUADRO.

CODIGO	REF.	COLOR
23344	5252	Blanco
23345	5252	Negro
23346	5252	Lac Plata
23347	5252	Lac Inox

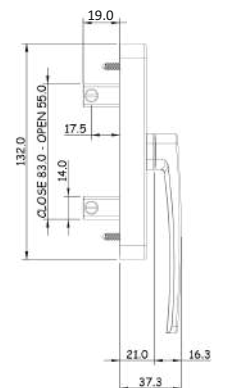
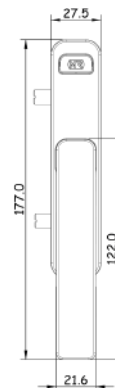

## Cremona apertura exterior. Linea CUADRO.

CODIGO	REF.	COLOR
24552	5230/36	Blanco
24553	5230/36	Negro
24554	5230/48	Blanco
24555	5230/48	Negra

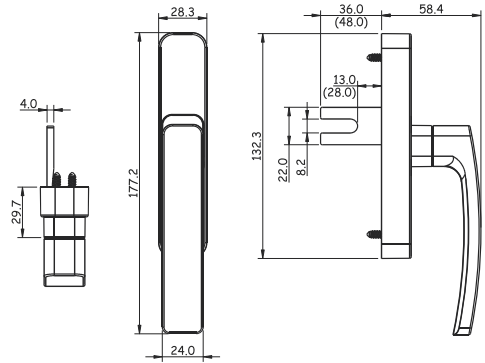

4

## Manilla Recuperable. Linea CUADRO. (Jgo)

CODIGO	REF.	COLOR
22179	5140	Blanco
22180	5140	Negro
22181	5140	Lac Plata
22182	5140	Lac Inox

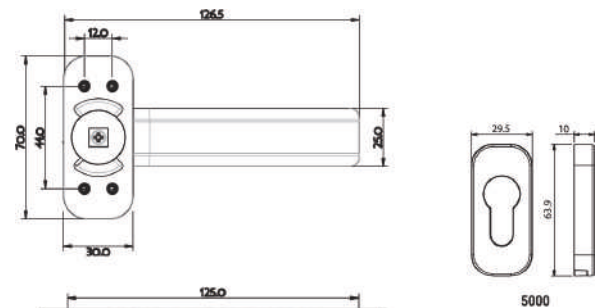

## Embellecedor seguridad. Linea CUADRO.

CODIGO	REF.	COLOR
22188	5000	Blanco
22189	5000	Negro
22190	5000	Lac Plata
22191	5000	Lac Inox

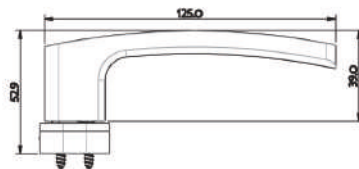

## Manilla recuperable con escudo. Linea CUADRO.

CODIGO	REF.	COLOR
22334	5150	Blanco
22335	5150	Negro
22336	5150	Lac Plata
22337	5150	Lac Inox

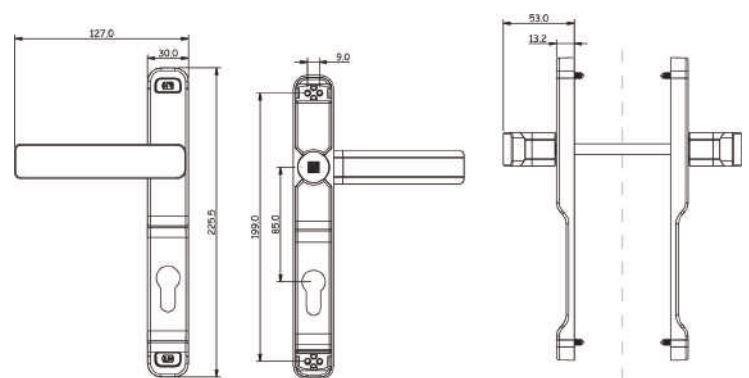

## Cierre presión. Linea CUADRO.

CODIGO	REF.	MANO	COLOR
24560	5280	Derecha	Blanco
24561	5280	Izquierda	Blanco
24568	5280	Derecha	Negro
24569	5280	Izquierda	Negro
24562	5280	Derecha	Lac Plata
24563	5280	Derecha	Lac Inox

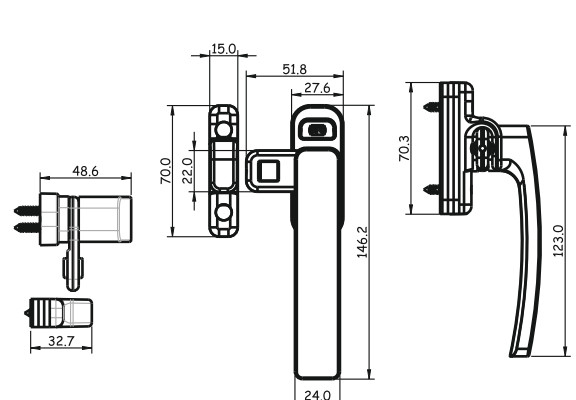



**Cremona interior 2 palas. Linea PRESTIGE**

CODIGO	REF.	COLOR
74	9530P	Blanco
3769	9530P	Negro
81	MANGO 9530	Blanco
957	MANGO 9530	Negro

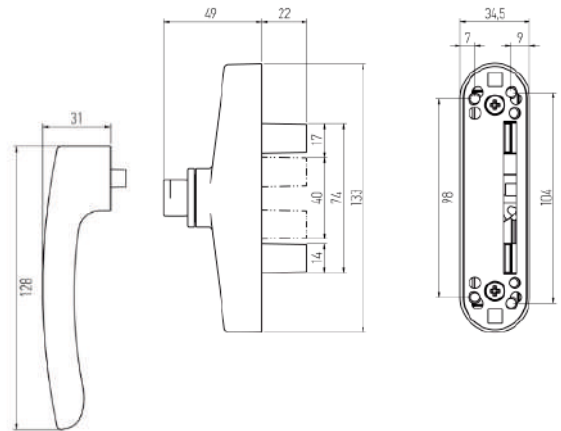

4

**Cremona apertura exterior 2 palas**

CODIGO	REF.	COLOR
281	9520P	Blanco
885	9520P	Negro
283	MANGO 9520	Blanco
952	MANGO 9520	Negro

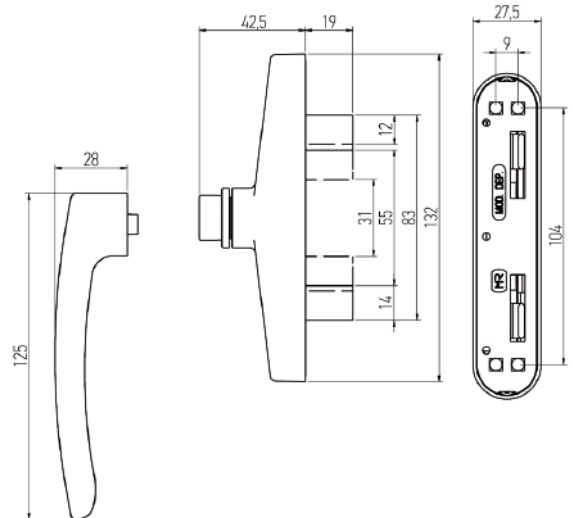

**Manilla elevable PRESTIGE.**

CODIGO	REF.	COLOR
14916	4330U	Blanco
14915	4330U	Negro
14917	4330U	Lac Plata
14918	4330U	Lac Inox

CODIGO	REF.	COLOR
14919	4330C/C	Blanco
14920	4330C/C	Negro
14921	4330C/C	Lac Plata
14922	4330C/C	Lac Inox



4330U



4330C/C

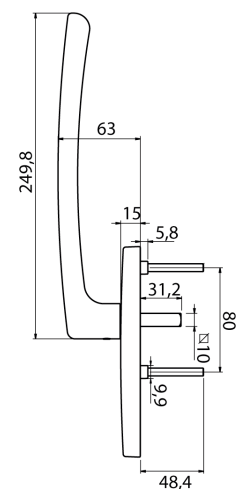



4

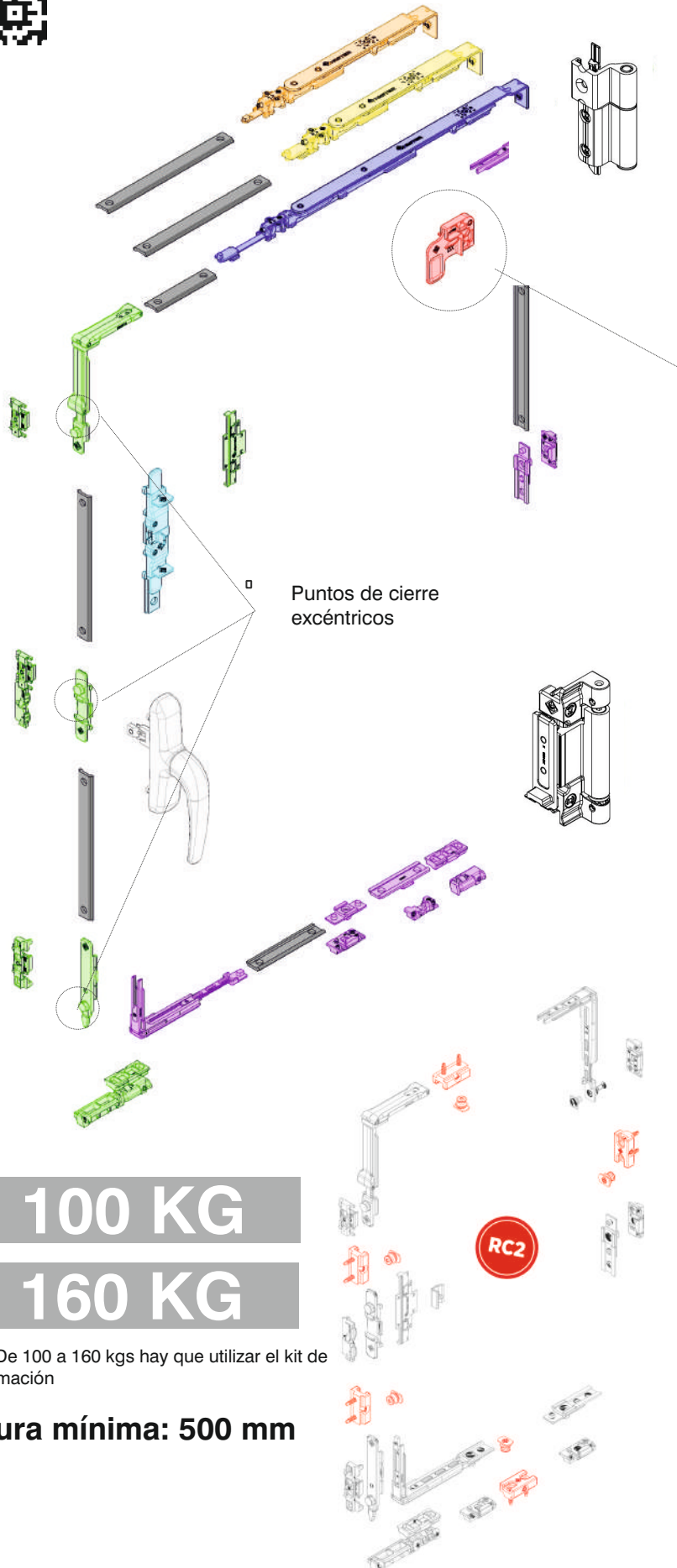

Puntos de cierre excéntricos

OPCIONAL:  
Código 6573

**100 KG**  
**160 KG**

**NOTA:** De 100 a 160 kgs hay que utilizar el kit de transformación

**Altura mínima: 500 mm**

### Kit de fijación para ventanas de 100 a 160 kgs:

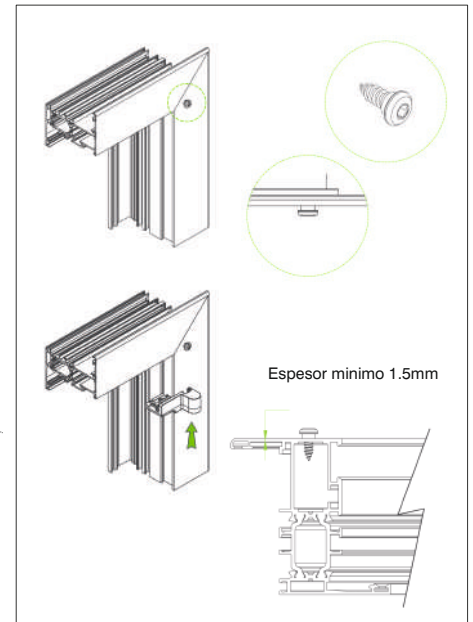

### Plantilla para bisagra superior (160 kgs)

CODIGO	REF.	
16108	3400.50	1



### Kit transformación de 100 a 160 kgs

CODIGO	REF.	COLOR	
18413	3420.52	Blanco	5
18414	3420.52	Negro	5
18415	3420.52	Plata	5
18416	3420.52	Inox	5

### Kit seguridad RC2

CODIGO	REF.	
14866	3400A.53	5

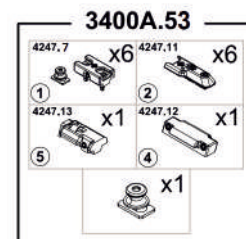

### Punto de cierre inox antipalanca

CODIGO	REF.	
21785	4247.7	50







4

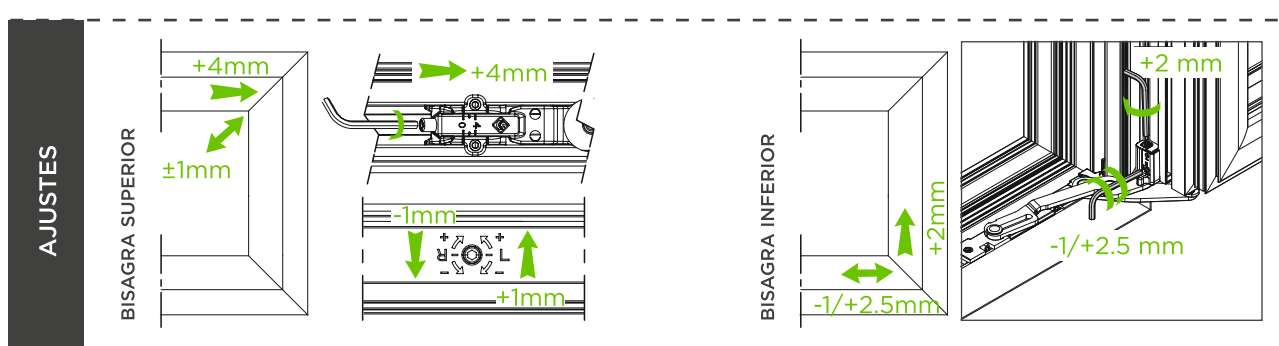
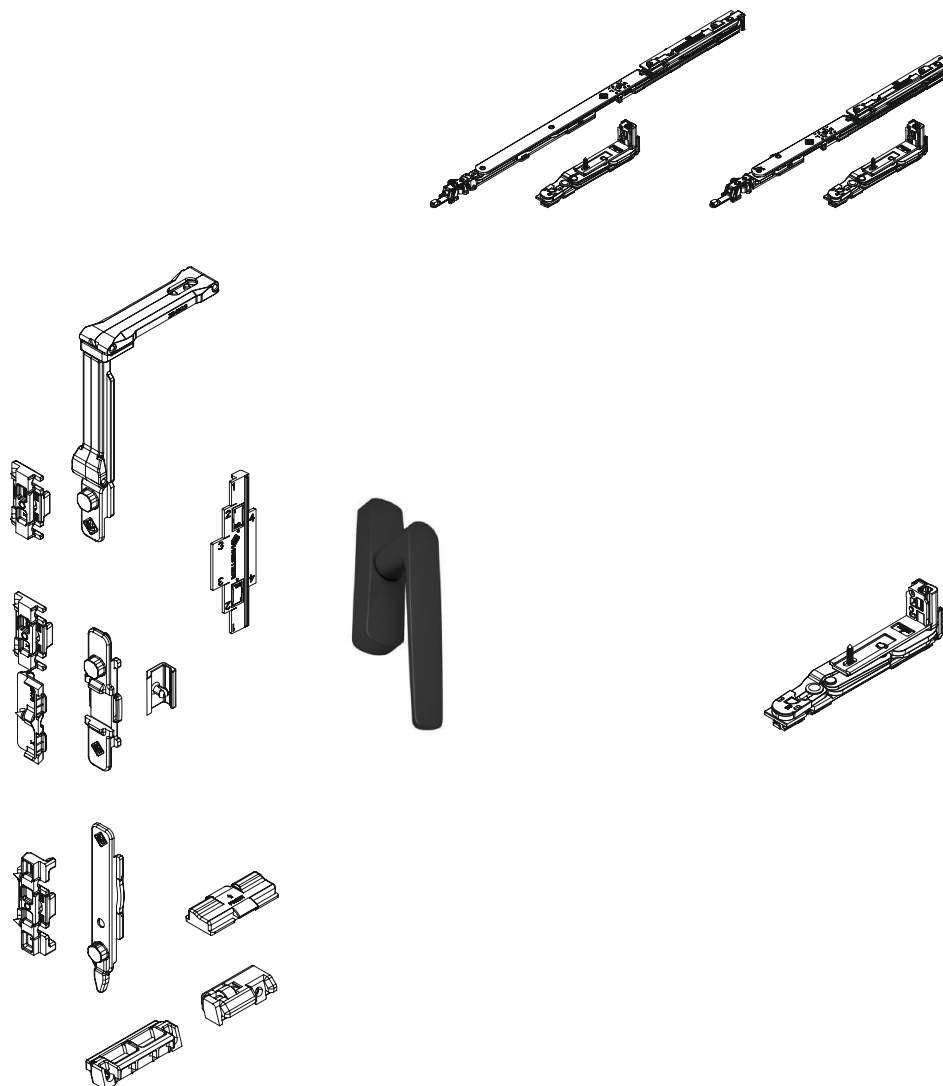

130 KG

180°

Altura mínima: 550 mm

## Oscilobatiente WEEN HIDE 180° (LINEA KARMA)



CODIGO	REF.	MEDIDA	MANO	COLOR
24802	WEEN HIDE	470/670	Dcha	Blanco
24810	WEEN HIDE	470/670	lqda	Blanco
24804	WEEN HIDE	470/670	Dcha	Negro
24812	WEEN HIDE	470/670	lqda	Negro
24806	WEEN HIDE	470/670	Dcha	Lac Plata
24814	WEEN HIDE	470/670	lqda	Lac Plata
24808	WEEN HIDE	470/670	Dcha	Lac Inox
24816	WEEN HIDE	470/670	lqda	Lac Inox
24803	WEEN HIDE	671/1500	Dcha	Blanco
24811	WEEN HIDE	671/1500	lqda	Blanco
24805	WEEN HIDE	671/1500	Dcha	Negro
24813	WEEN HIDE	671/1500	lqda	Negro
24807	WEEN HIDE	671/1500	Dcha	Lac Plata
24815	WEEN HIDE	671/1500	lqda	Lac Plata
24809	WEEN HIDE	671/1500	Dcha	Lac Inox
24817	WEEN HIDE	671/1500	lqda	Lac Inox



### Kit base oculto

CODIGO	REF.
24874	3320G.3

### Bisagras + compás sin cremóna

CODIGO	REF.	MEDIDA	MANO
24870	A3304.10D	470/670	Dcha
24871	A3304.10S	470/670	lqda
24872	A3304.11D	671/1500	Dcha
24873	A3304.11S	671/1500	lqda

**NOTA:** Para ventanas con medidas de 1200 o mas, utilizar compas suplementario código 6563.

### Juego bisagra 2ª hoja

CODIGO	REF.	
24834	3304.12D	Dcha
24835	3304.12S	lqda

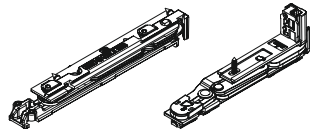

### Pasador Ween (incluye los cerraderos)

CODIGO	REF.	
15497	3420.51	5



### Pasador palanca Ween con punteras metalicas (incluye cerraderos)

CODIGO	REF.	
11293	4515.52	5



### Punto cierre oculto

CODIGO	REF.	
8044	40809	50



### Mecanismo unidireccional con antifalsa maniobra

CODIGO	REF.	
6512	3627	20

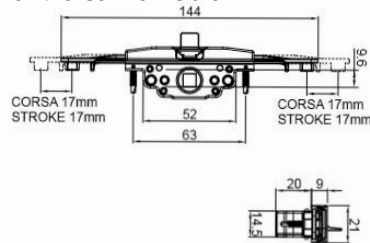

**NOTA:** El mecanismo unidireccional no lleva punto de cierre. Si lo necesita hay que poner el código 6565 (Cierre 3º punto 3520.32 + 1400 ms)

### Ángulo extra de reenvío

CODIGO	REF.	
15494	3400G.31	10



### Kit microventilación regulable.

CODIGO	REF.	
6652	3520.39	1



### Cerradura Clark

CODIGO	REF.	COLOR
8144	3022.1	Blanco
8143	3022.1	Negro

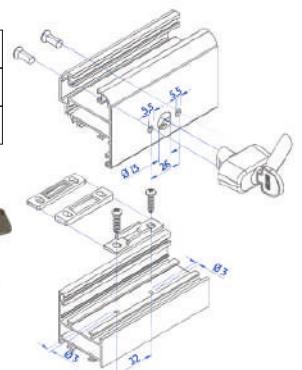

**Manilla Multifunción. Linea KARMA.**

CODIGO	REF.	COLOR	
24826	3100	Blanco	20
24827	3100	Negro	20
24828	3100	Lac Plata	20
24829	3100	Lac Inox	20

**Kit para manilla doble**

CODIGO	REF.	
11842	83070B.10	1

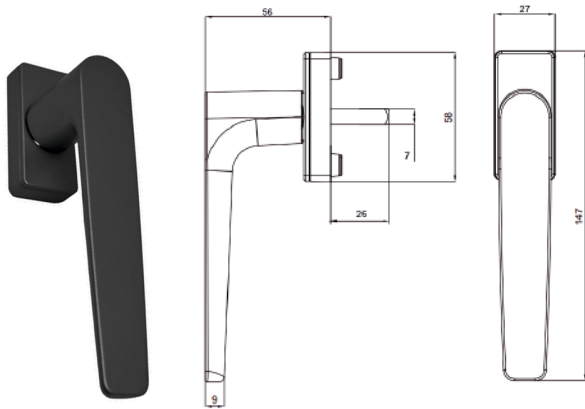

**Manilla Multifunción larga. Linea KARMA.**

CODIGO	REF.	COLOR	
24842	3081.8	Blanco	2
24843	3081.8	Negro	2
24844	3081.8	Lac Plata	2
24845	3081.8	Lac Inox	2

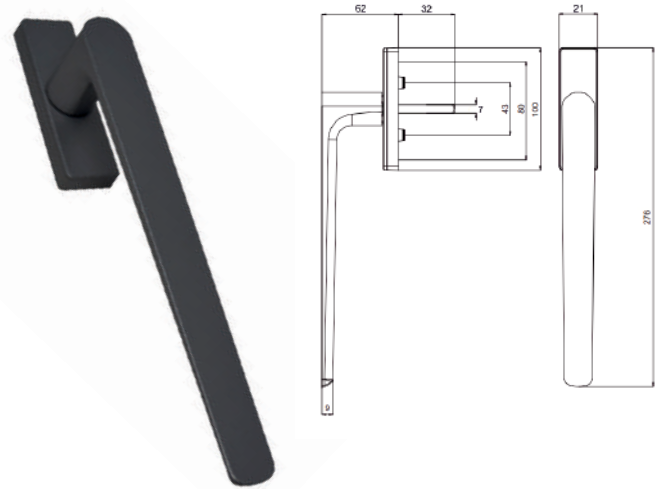

4

**Manilla Multifunción plana. Linea KARMA**

CODIGO	REF.	COLOR	
24838	3106.30	Blanco	20
24839	3106.30	Negro	20
■ 24840	3106.30	Lac Plata	20
■ 24841	3106.30	Lac Inox	20

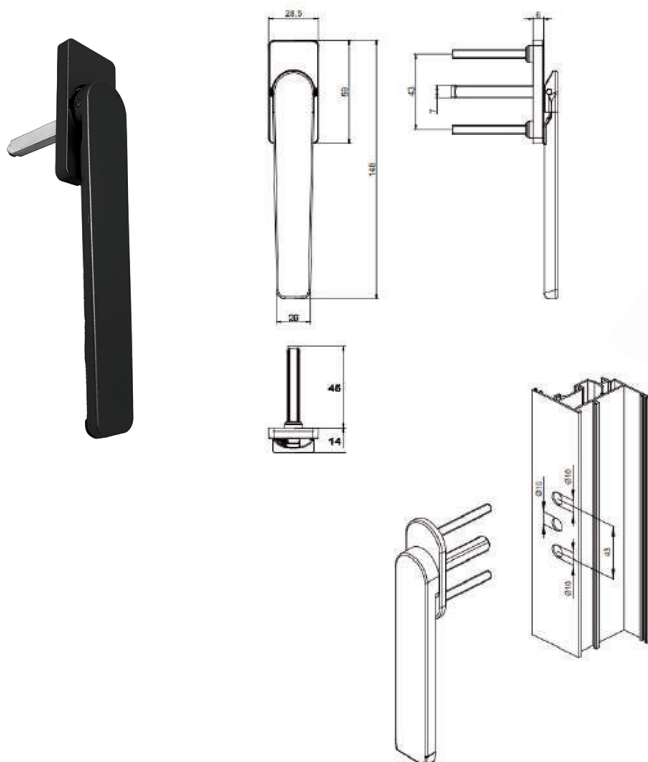

**Manilla Multifunción acodada. Linea KARMA**

CODIGO	REF.	COLOR	MANO	
24850	3102S	Blanco	Dcha	5
24846	3102D	Blanco	Izqda	5
24851	3102S	Negro	Dcha	5
24847	3102D	Negro	Izqda	5
24852	3102S	Lac Plata	Dcha	5
24848	3102D	Lac Plata	Izqda	5
24853	3102S	Lac Inox	Dcha	5
24849	3102D	Lac Inox	Izqda	5

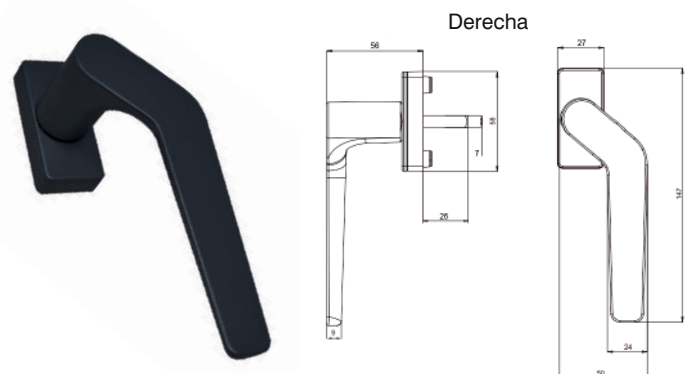

**NOTA:** La mano de la manilla es según el desplazamiento de la manilla y no de la posición de la manilla en la ventana.

**Cremona interior 2 palas LINEA KARMA**

CODIGO	REF.	COLOR	
24818	6060	Blanco	20
24819	6060	Negro	20
24820	6060	Lac Plata	20
24821	6060	Lac Inox	20

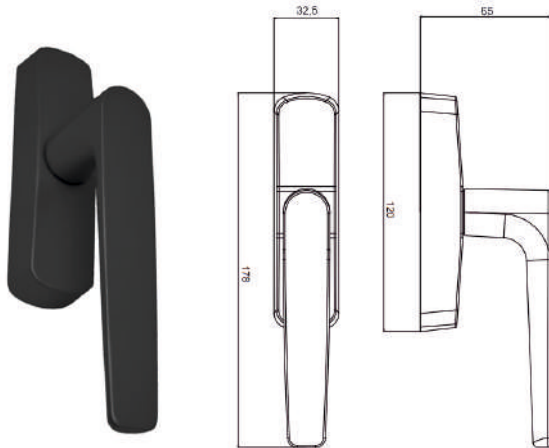

**Manilla recuperable. Linea KARMA (Jgo)**

CODIGO	REF.	COLOR	
24822	3067	Blanco	15
24823	3067	Negro	15
24824	3067	Lac Plata	15
24825	3067	Lac Inox	15

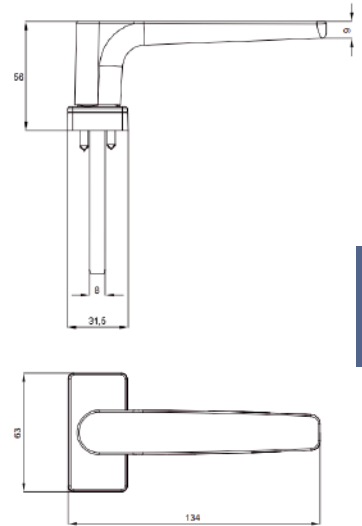

4

**Embellecedor bombillo. Linea KARMA**

CODIGO	REF.	COLOR	
18807	2129.4	Blanco	20
19059	2129.4	Negro	20
16103	2129.4	Lac Plata	20
18481	2129.4	Lac Inox	20

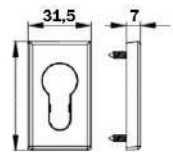

**Manilla elevable y uñero LINEA KARMA**

CODIGO	REF.	COLOR	
24830	3081.20	Blanco	2
24831	3081.20	Negro	
24832	3081.20	Lac Plata	
24833	3081.20	Lac Inox	

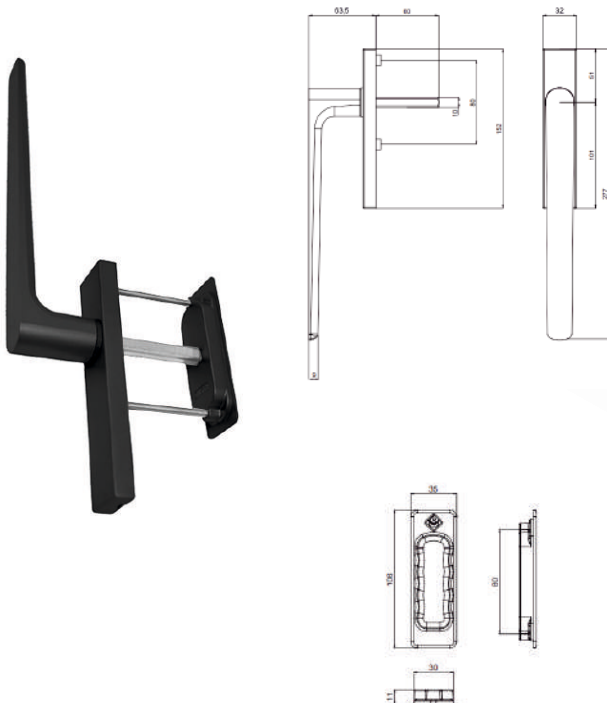

**Manilla multifunción minimalista- LINEA KARMA (cuadradillo regulable de 23,5 a 33mm)**

CODIGO	REF.	COLOR	
23815	3091	Blanco	5
24875	3091	Negro	5
24876	3091	Lac Plata	5
24877	3091	Lac Inox	5

**NOTA:** No valido un cuadradillo convencional de 7mm

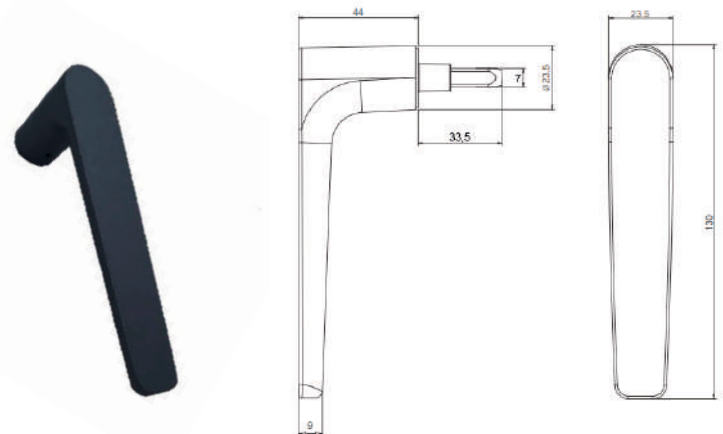

**Mecanismo unidireccional con falsa maniobra**

CODIGO	REF.	
1505	3630	10

## Manilla Multifuncion. Linea CONFORT

### Cuadradillo de 24mm

### Cuadradillo de 44mm

CODIGO	REF.	COLOR
6787	3070	Blanco
6788	3070	Negro
7261	3070	Lac Plata
8033	3070	Lac Inox

CODIGO	REF.	COLOR
5833	3071	Blanco
5834	3071	Negro

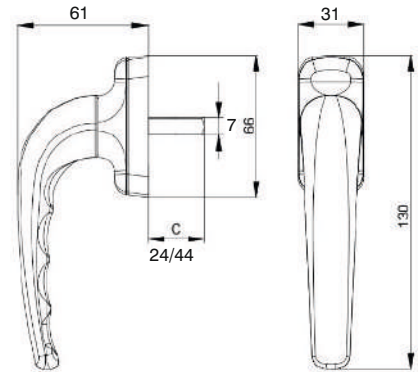

4

## Juego Manilla Multifunción (interior y exterior) (máxima distancia entre perfiles 64mm)

CODIGO	REF.	COLOR
7161	3070.10	Blanco
7162	3070.10	Negro
9907	3070.10	Lac Plata
9881	3070.10	Lac Inox

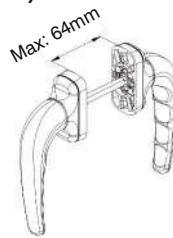

## Manilla Multifuncion con llave Linea CONFORT

### Cuadradillo de 24mm

CODIGO	REF.	COLOR
6581	3070.2	Blanco
6789	3070.2	Negro
9276	3070.2	Lac Plata
8779	3070.2	Lac Inox

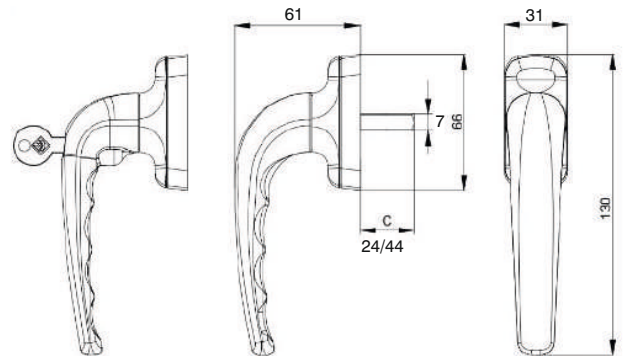

### Cuadradillo de 44mm

CODIGO	REF.	COLOR
8858	3071.2	Blanco
8859	3071.2	Negro



## Manilla multipunto plana. Linea CONFORT.

CODIGO	REF.	COLOR
19061	3074.7	Blanco
19062	3074.7	Negro
19063	3074.7	Lac Plata
19064	3074.7	Lac Inox

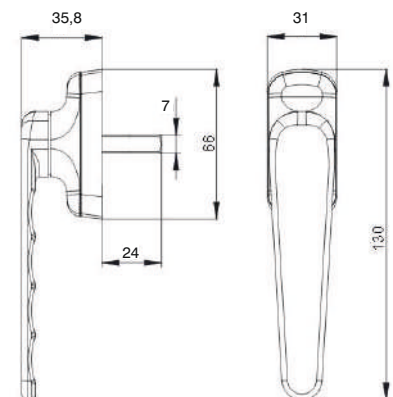



## Cremona interior 2 palas. Linea CONFORT

CODIGO	REF.	COLOR	
■ 8169	6005	Blanco	20
■ 8171	6005	Negro	20
■ 8607	6005	Lac Plata	20
■ 8172	6005	Lac Inox	20

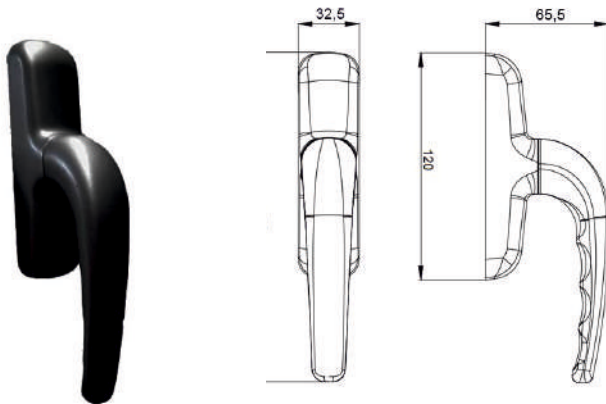

## Cremona interior 2 palas con llaves iguales. Linea CONFORT

CODIGO	REF.	COLOR	
■ 8691	6035.1 con llave	Blanco	5
■ 8692	6035.1 con llave	Negro	5
■ 12113	6035.1 con llave	Lac Plata	5
■ 8684	6035.1 con llave	Lac Inox	5

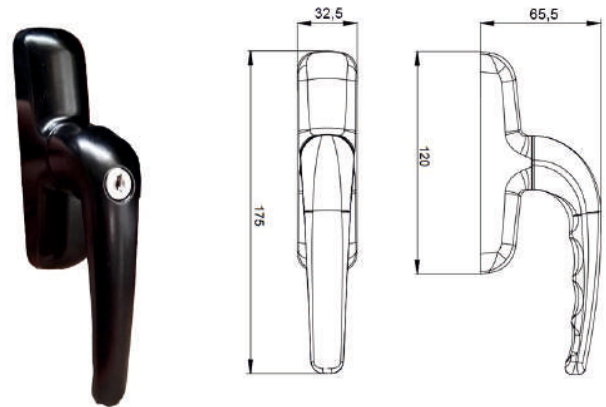

4

## Manilla recuperable. Linea CONFORT. (Jgo)

CODIGO	REF.	COLOR	
■ 6758	3060	Blanco	15
■ 6759	3060	Negro	15
■ 7260	3060	Lac Plata	15
■ 8032	3060	Lac Inox	15

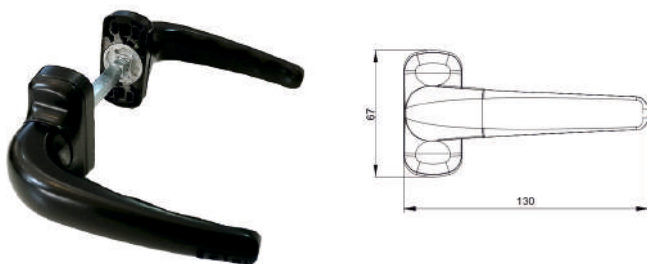

## Manilla recuperable plana. Linea CONFORT. (Jgo)

CODIGO	REF.	COLOR	
■ 8794	3063	Blanco	15
■ 10219	3063	Negro	15

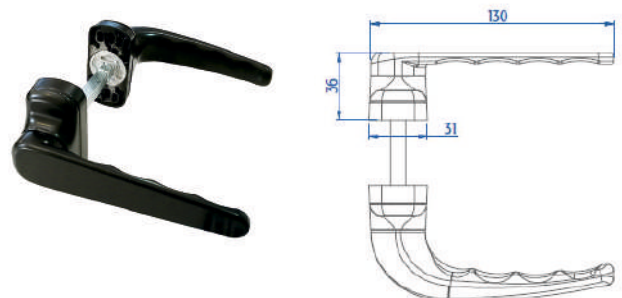

## Manilla multifuncion SILHOUETTE

CODIGO	REF.	COLOR	
15288	250	Blanco	20
15289	250	Negro	20

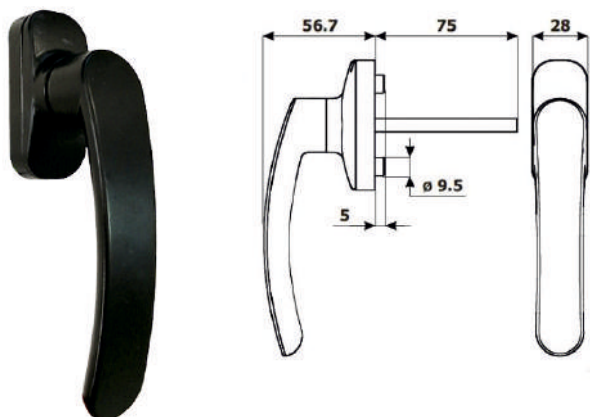

## Manilla multifuncion con llave

CODIGO	REF.	COLOR	
15292	250CV	Blanco	20
15291	250CV	Negro	20

## Manilla multifuncion con llave DOBLE (solo lleva llave una manilla)

CODIGO	REF.	COLOR	
15195	251CV	Blanco	10
15196	251CV	Negro	10

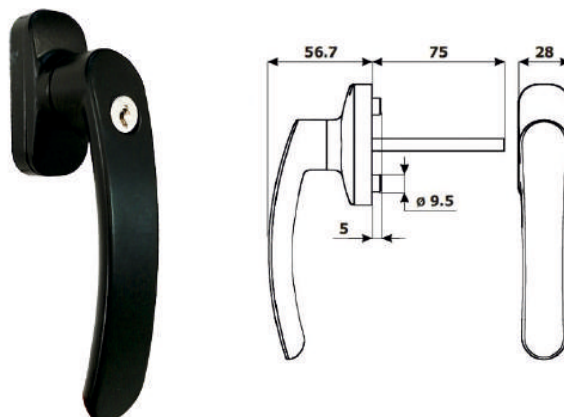

4

## Manilla recuperable SILHOUETTE

CODIGO	REF.	COLOR	
15301	210	Blanco	10
15302	210	Negro	10

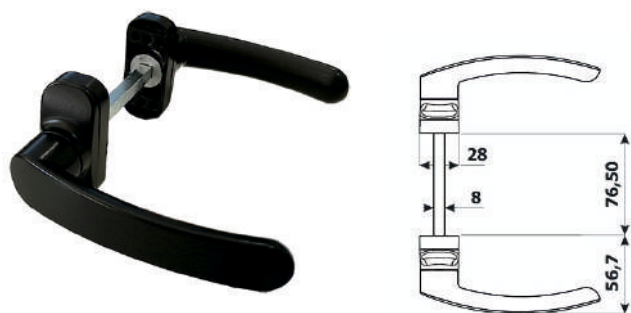

## Manilla recuperable con llave

CODIGO	REF.	COLOR	
14876	210CV	Blanco	10
14877	210CV	Negro	10

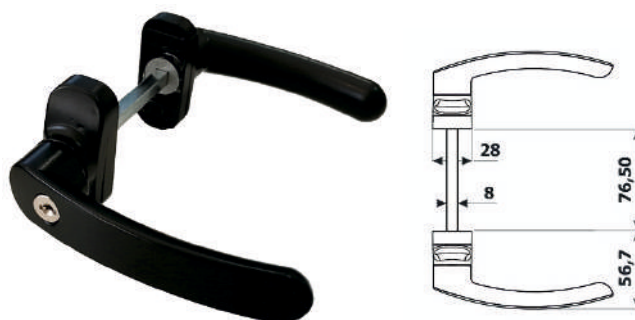

## Manilla recuperable plana

CODIGO	REF.	COLOR	
15303	210MR	Blanco	10
15304	210MR	Negro	10

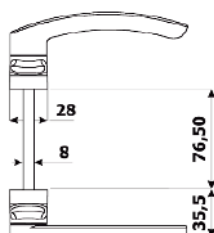



**Cremona oscilo con muelle SILHOUETTE**

CODIGO	REF.	COLOR	
15287	382	Blanco	10
15286	382	Negro	10

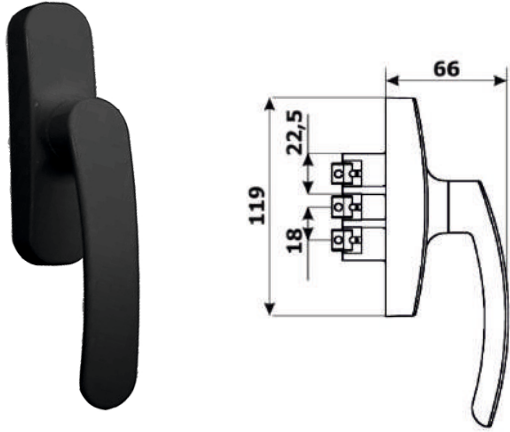

**Cremona oscilo con muelle y con llave**

CODIGO	REF.	COLOR	
15285	382CV	Blanco	10
15284	382CV	Negro	10

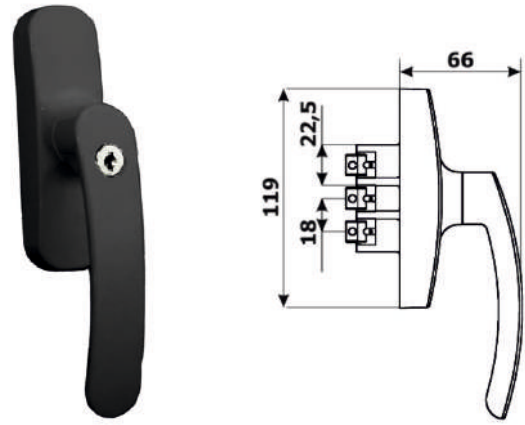

4

**Cremona ap. interior SILHOUETTE**

CODIGO	REF.	COLOR	
15294	380	Blanco	20
15293	380	Negro	20

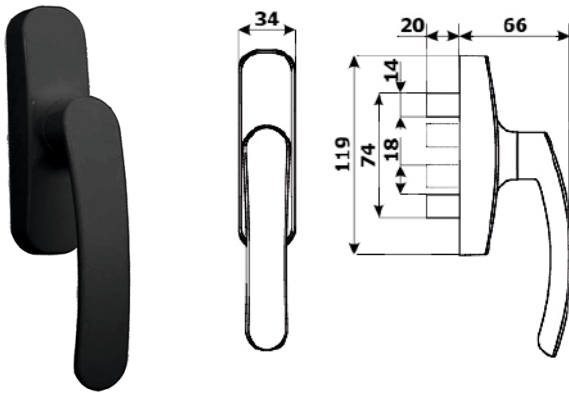

**Cremona ap. interior con llave**

CODIGO	REF.	COLOR	
15295	380CV	Blanco	10
15296	380CV	Negro	10

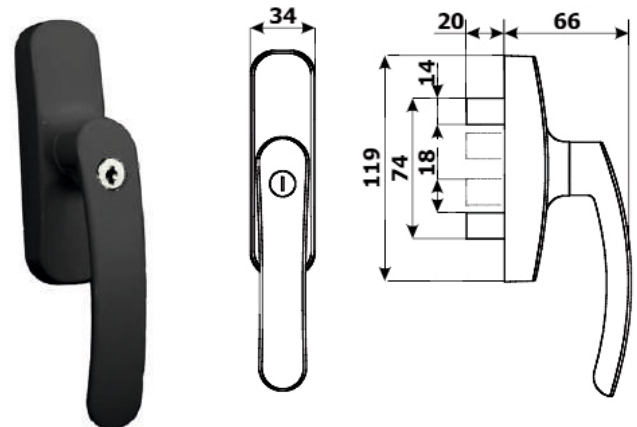

**Cremona ap. interior sin mango**

CODIGO	REF.	COLOR	
15298	380ME	Blanco	10
15297	380ME	Negro	10

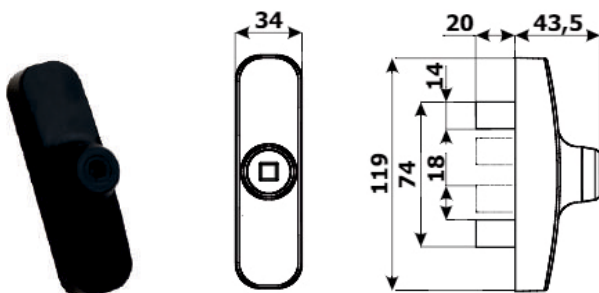

**Mango SILHOUETTE**

CODIGO	COLOR	
15299	Blanco	10
15300	Negro	10



*fapim*<sup>®</sup>

**GALICUBE**

4

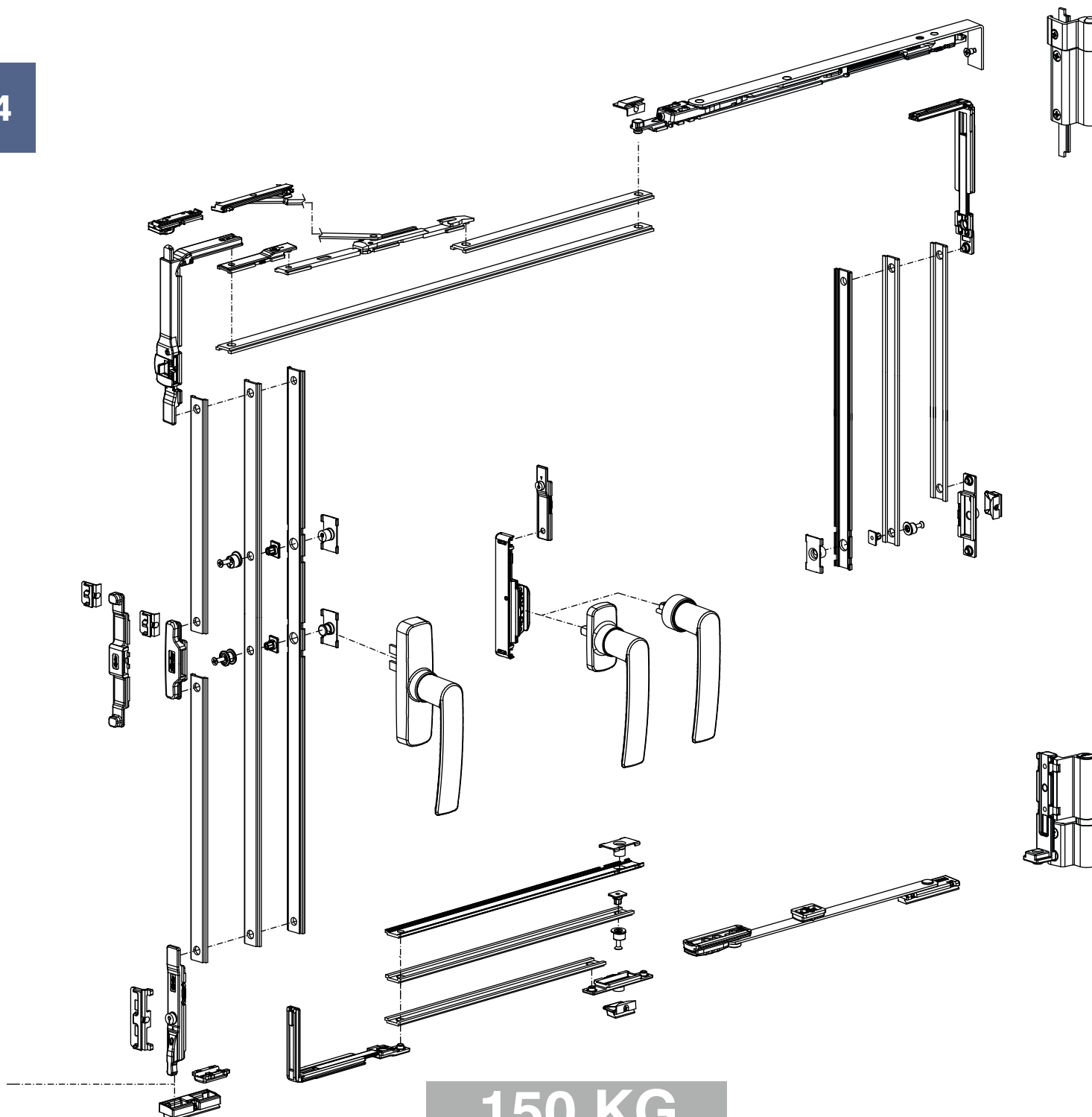

**150 KG**

**Altura mínima: 450 mm**

**Medida mínima con pieza 0520: 480mm (260mm a centro manilla)**

**NOTA:** Este oscilo está disponible también con maniobra lógica.

## Oscilobatiente 1 HOJA con cremona GEA

CODIGO	REF.	MEDIDA	COLOR	CODIGO	REF.	MEDIDA	COLOR
23482	1336AF_58	364/700	Blanco	23460	1336BF_58	562/1200	Blanco
23479	1336AF_37	364/700	Negro	23462	1336BF_37	562/1200	Negro
23481	1336AF_G6	364/700	Lac Plata	23463	1336BF_G6	562/1200	Lac Plata
23476	1336AF_MV	364/700	Lac Inox	23478	1336BF_MV	562/1200	Lac Inox
23459	1336AF_58	402/750	Blanco	23483	1336AF_58	816/1700	Blanco
23461	1336AF_37	402/750	Negro	23480	1336AF_37	816/1700	Negro
23473	1336AF_G6	402/750	Lac Plata	23474	1336AF_G6	816/1700	Lac Plata
23475	1336AF_MV	402/750	Lac Inox	23477	1336AF_MV	816/1700	Lac Inox



**NOTA:** Para ventanas con medidas de 1200 a 1700 es aconsejable utilizar compas suplementario código 15545 y el empalme 179

4

### Bisagra 2ª hoja de 3 cuerpos

CODIGO	REF.	COLOR	Icono
23465	1414AI	Blanco	10
23467	1414AI	Negro	10
23468	1414AI	Lac Plata	10
23466	1414AI	Lac Inox	10



### Angulo de reenvio

CODIGO	REF.	Icono
13470	1497A	10



### Angulo de reenvio (sin punto de cierre, para máquina)

CODIGO	REF.	Icono
12408	1495AIZ5	50



### Punto cierre oculto

CODIGO	REF.	Icono
8044	-----	50



### Pasador inferior GALICUBE

CODIGO	REF.	Icono
13433	1504B	10

1504B 1500A



### Pasador superior GALICUBE

CODIGO	REF.	MEDIDA	Icono
12554	1500A	215mm	50
12555	1500B	400mm	50



### Juego pasadores 2ª hoja

CODIGO	REF.	TIPO	Icono
14960	1503A	superior	10
15224	1503B	inferior	10

### Cerradero superior metálico

CODIGO	REF.	Icono
19336	4135A	50



### Cerradero inferior metálico

CODIGO	REF.	Icono
20532	4135B	50



### Microventilacion

CODIGO	REF.	Icono
14147	1618	1



### Empalme cremona

CODIGO	REF.	TIPO	Icono
12399	1565I6	Pletina aluminio	100
12400	1563I	Pletina poliamida	100
13431	1559A	Manual	50



### Punto de cierre hoja

CODIGO	REF.	TIPO	Icono
12405	1596I6	Pletina aluminio	100
12404	1593I	Pletina poliamida	100



### Cerradero marco

CODIGO	REF.	Icono
12406	1597I	100



### Mecanismo unidireccional (90º y 180º) (especial para manilla IRIS)

CODIGO	REF.	Icono
15650	0520	10



### Mecanismo unidireccional (180º)

CODIGO	REF.	Icono
12774	0650	10



### Manilla IRIS

CODIGO	REF.	COLOR	Icono
15648	0500A_58	Blanco	10
15647	0500A_37	Negro	10
15649	0500A_G6	Lac Plata	10
16205	0500A_MV	Lac Inox	10



### Falleba CE poliamida

CODIGO	REF.	Icono
12407	1683	250



**fapim**

Oscilo con bisagras ocultas

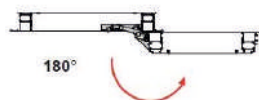

4

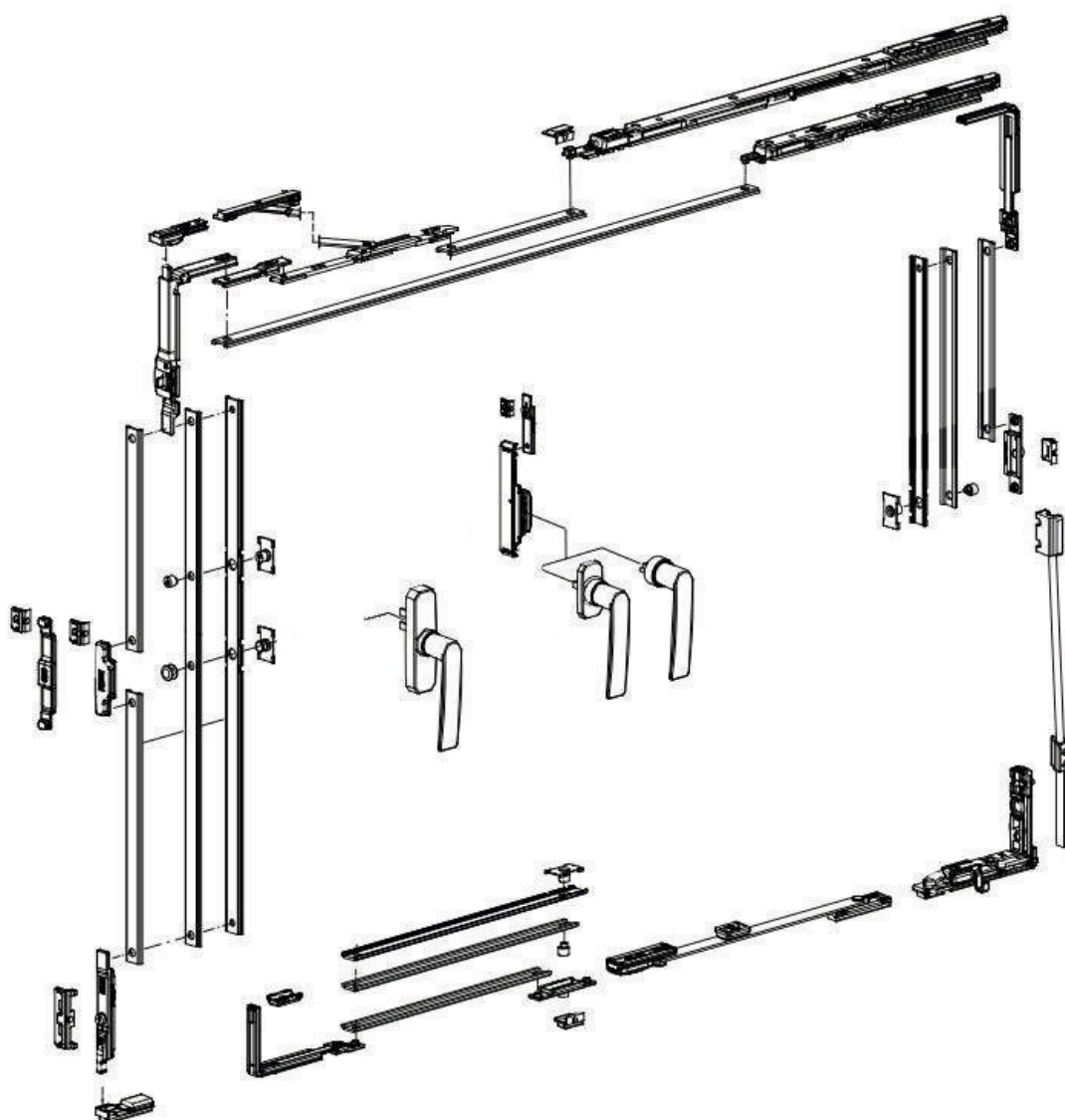

**180 KG**

Altura mínima: 600 mm

**NOTA:** Este oscilo está disponible también con maniobra lógica.



## Oscilobatiente MAGICUBE / GEA

CODIGO	REF.	MEDIDA	COLOR
■ 18046	MAGICUBE/GEA	422/800	Blanco dcha
■ 18048	MAGICUBE/GEA	422/800	Blanco izq
■ 18047	MAGICUBE/GEA	422/800	Negro dcha
■ 18049	MAGICUBE/GEA	422/800	Negro izq
19067	MAGICUBE/GEA	422/800	Plata dcha
19068	MAGICUBE/GEA	422/800	Plata izq
19069	MAGICUBE/GEA	422/800	Inox dcha
19070	MAGICUBE/GEA	422/800	Inox izq
■ 18054	MAGICUBE/GEA	700/1700	Blanco dcha
■ 18055	MAGICUBE/GEA	700/1700	Blanco izq
■ 18056	MAGICUBE/GEA	700/1700	Negro dcha
■ 18057	MAGICUBE/GEA	700/1700	Negro izq
19071	MAGICUBE/GEA	700/1700	Plata dcha
19073	MAGICUBE/GEA	700/1700	Plata izq
19074	MAGICUBE/GEA	700/1700	Inox dcha
19075	MAGICUBE/GEA	700/1700	Inox izq



## Oscilobatiente MAGICUBE / IRIS

CODIGO	REF.	MEDIDA	COLOR
■ 18050	MAGICUBE/IRIS	422/800	Blanco dcha
■ 18052	MAGICUBE/IRIS	422/800	Blanco izq
■ 18051	MAGICUBE/IRIS	422/800	Negro dcha
■ 18053	MAGICUBE/IRIS	422/800	Negro izq
■ 19076	MAGICUBE/IRIS	422/800	Plata dcha
■ 19077	MAGICUBE/IRIS	422/800	Plata izq
■ 18662	MAGICUBE/IRIS	422/800	Inox dcha
■ 18663	MAGICUBE/IRIS	422/800	Inox izq
■ 18058	MAGICUBE/IRIS	700/1700	Blanco dcha
■ 18059	MAGICUBE/IRIS	700/1700	Blanco izq
■ 18060	MAGICUBE/IRIS	700/1700	Negro dcha
■ 18061	MAGICUBE/IRIS	700/1700	Negro izq
■ 19078	MAGICUBE/IRIS	700/1700	Plata dcha
■ 19079	MAGICUBE/IRIS	700/1700	Plata izq
■ 18664	MAGICUBE/IRIS	700/1700	Inox dcha
■ 18665	MAGICUBE/IRIS	700/1700	Inox izq

4

## Bisagra 2ª hoja GALICUBE

CODIGO	REF.		
■ 17294	1204R	derecha	10
■ 17295	1204L	izquierda	10



**NOTA:** Juego bisagras ocultas para batiente código 18795

## Angulo de reenvio

CODIGO	REF.	
■ 13470	1497A	10



## Angulo de reenvio (sin punto de cierre, para máquina)

CODIGO	REF.	
12408	1495AIZ5	50

## Pasador inferior GALICUBE

CODIGO	REF.	
■ 13433	1504B	10

1504B 1500A



## Pasador superior GALICUBE

CODIGO	REF.		
■ 12554	1500A	215mm	50
■ 12555	1500B	400mm	50

## Juego pasadores 2ª hoja

CODIGO	REF.		
14960	1503A	superior	10
15224	1503B	inferior	10



## Cerradero sup metalico

CODIGO	REF.	
19336	4135A	50



## Cerradero inferior metálico

CODIGO	REF.	
20532	4135B	50



## Microventilacion

CODIGO	REF.	
14147	1618	1



## Empalme cremona

CODIGO	REF.		
12399	1565I6	Pletina aluminio	100
■ 12400	1563I	Pletina poliamida	100
13431	1559A	Manual	50



1563I 1565I6



1559A

## Punto de cierre hoja

CODIGO	REF.		
■ 12405	1596I6	Pletina aluminio	100
■ 12404	1593I	Pletina poliamida	100



1596I6 1593I

## Cerradero marco

CODIGO	REF.	
■ 12406	1597I	100





**Manilla multifuncion con escudo EOS**

CODIGO	REF.	COLOR	
16741	0510A	Blanco	10
16775	0510A	Negro	10
15818	0510A	Lac Plata	10
17835	0510A	La Inox	10

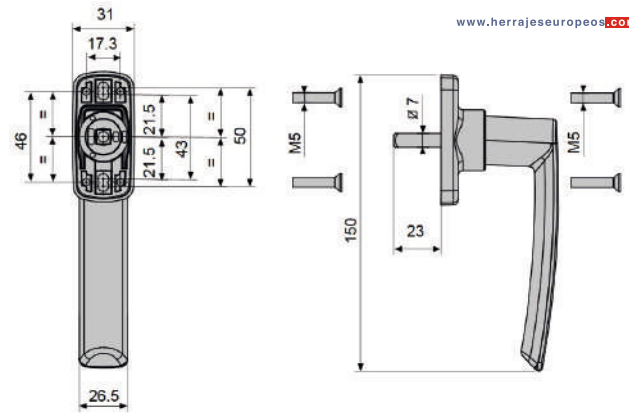

4

**NOTA:** Para hacer la manilla doble utilizar el tornillo y la tuerca pag. 105

**Manilla Multifuncion IRIS**

Cuadradillo de 19,5mm

CODIGO	REF.	COLOR	
15648	0500A	Blanco	10
15647	0500A	Negro	10
15649	0500A	Lac Plata	10
16205	0500A	Lac Inox	10

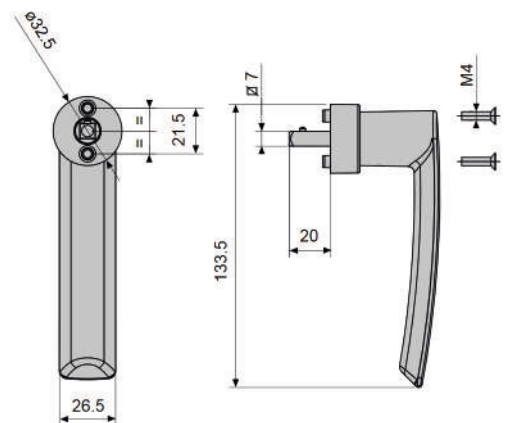

**NOTA:** La manilla IRIS hay que utilizarla obligatoriamente con el mecanismo 0520 (ver pag.73)

**Manilla recuperable HERA (Jgo)**

CODIGO	REF.	COLOR	
16778	2041I	Blanco	10
16147	2041I	Negro	10
17319	2041I	Lac Plata	10
17834	2041I	Lac Inox	10

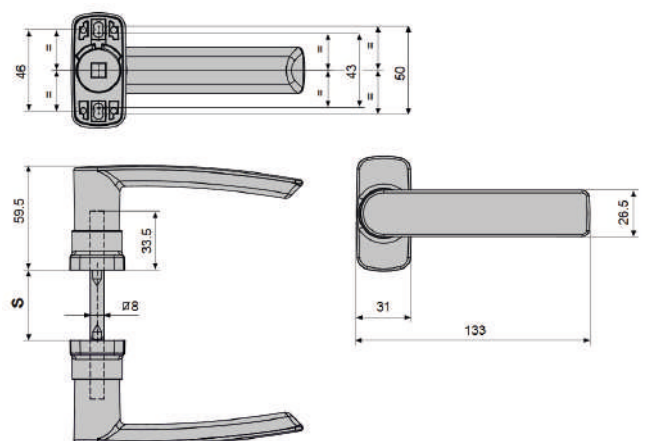

**Cremona 2 palas GEA**

CODIGO	REF.	COLOR	
16776	540BI	Blanco	10
16777	540BI	Negro	10
17733	540B	Lac Plata	10
17833	540B	Lac Inox	10

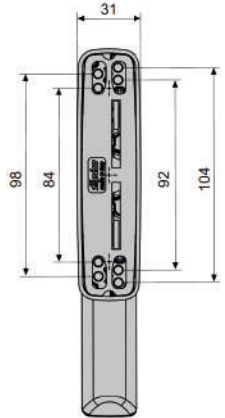
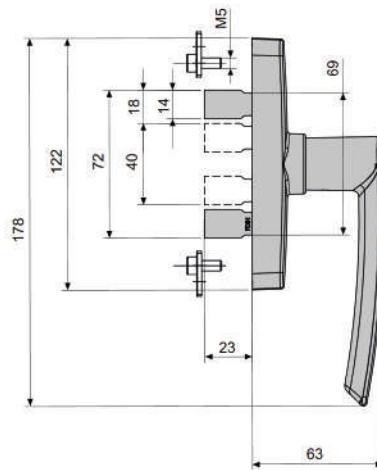

**Cremona 1 pala GEA**

CODIGO	REF.	COLOR	
16309	0530BI	Blanco	10
16146	0530BI	Negro	10
16623	0530B	Lac Plata	10
16985	0530B	Lac Inox	10

4

**Cremona 2 palas llave GEA**

CODIGO	REF.	COLOR	
17766	0541BI	Blanco	10
19080	0541BI	Negro	10
19081	0541B	Lac Plata	10
19082	0541B	Lac Inox	10

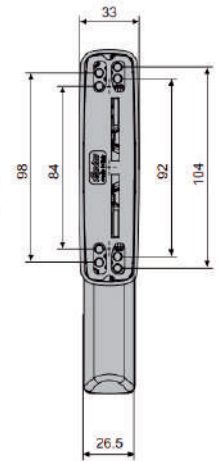
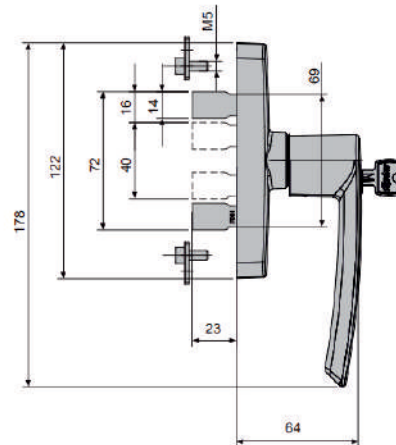

**Cremona 1 pala llave GEA**

CODIGO	REF.	COLOR	
16742	0531BI	Blanco	10
18130	0531BI	Negro	10
19083	0531B	Lac Plata	10
19085	0531B	Lac Inox	10

**Cremona ap. exterior GAIA**

CODIGO	REF.	COLOR	
1576	1800A	Blanco	10
15763	1800A	Negro	10
15765	1800A	Lac Plata	10
15776	1800A	Lac Inox	10

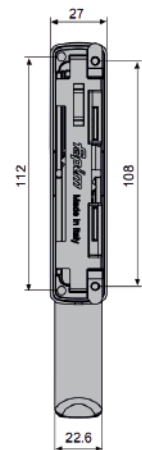
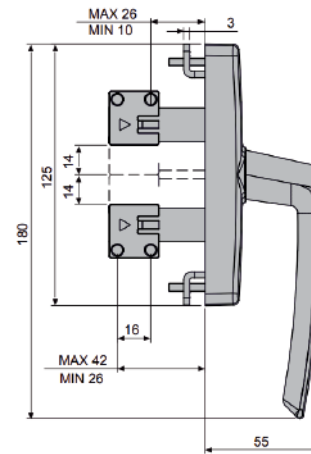

**Pernio M6 INOX para cremona GAIA**

CODIGO	REF.	
6128	15mm	1
2951	22mm	1



**Empalme cremona**

CODIGO	REF.	
18582	1946A	Par empalme 6 Ø 50



1946A

**Puntera nylon CE 6mm Ø**

CODIGO	REF.	
18583	4082A	100



**Cremona ap. exterior GAIA con llave**

CODIGO	REF.	COLOR	
16151	1801A	Blanco	10
15846	1801A	Negro	10
■ 15848	1801A	Plata	10
■ 1586	1801A	Inox	10

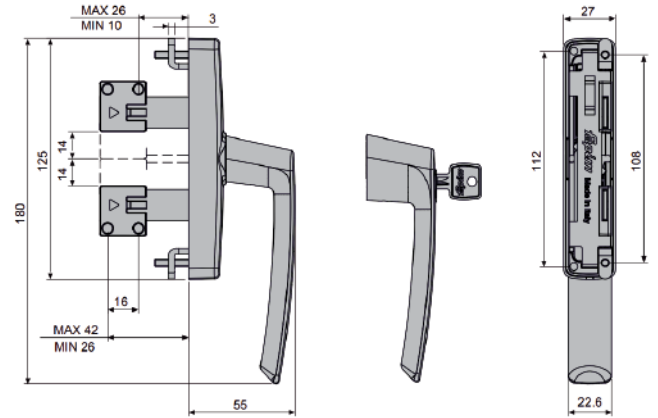

4

**NOTA:** Utilizar los pernios pag. 102.

**Cremona ap. exterior GAIA plana**

CODIGO	REF.	COLOR	
15874	1806A	Blanco	10
1589	1806A	Negro	10
■ 15951	1806A	Plata	10
■ 1602	1806A	Inox	10

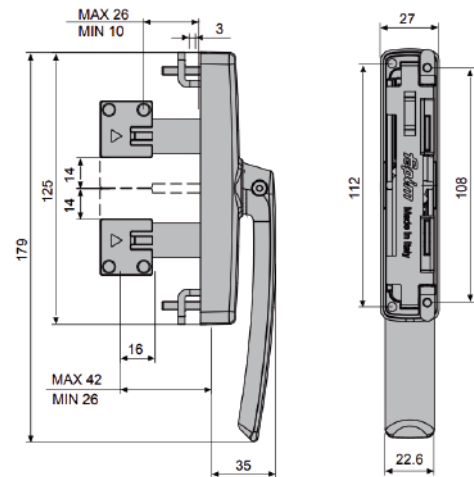

**NOTA:** Utilizar los pernios pag. 102.

**Manilla elevable PRISMA (sin entrada cilindro)**

CODIGO	REF.	COLOR	
16152	5126AC	Blanco	1
16154	5126AC	Negro	1
16160	5126AC	Lac Plata	1
16161	5126AC	Lac Inox	1

**Manilla elevable PRISMA (con entrada cilindro)**

CODIGO	REF.	COLOR	
24881	5126EF	Blanco	1
25169	5126EF	Negro	1

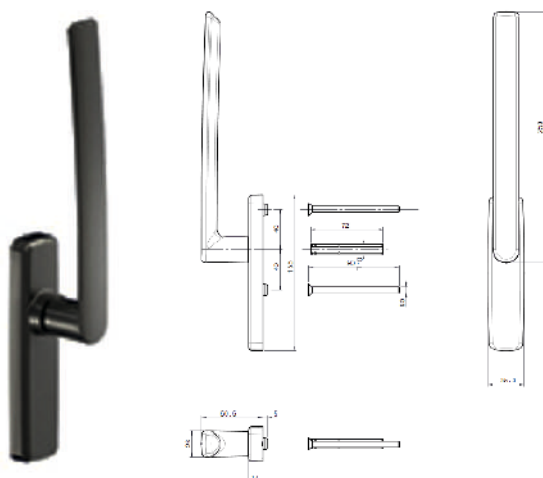

**Uñero elevable 11mm**

CODIGO	REF.	COLOR	
16162	5129ZA	Blanco	1
16163	5129ZA	Negro	1
16204	5129ZA	Lac Plata	1
16290	5129ZA	Lac Inox	1

**Uñero elevable 6,5 mm**

CODIGO	REF.	COLOR	
24052	5129ZM	Blanco	1
23452	5129ZM	Negro	1

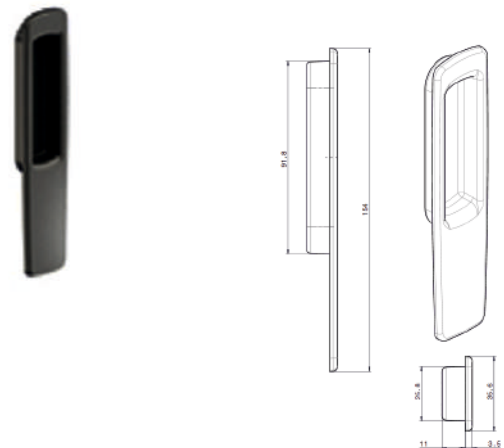

**NOTA:** La manilla elevable incluye el eje de 72mm y tornillos de 90mm.



## GALICUBE

### Oscilo con bisagras vistas

#### Oscilobatiente 1 HOJA con cremón Blanda

CODIGO	REF.	MEDIDA	COLOR
20075	S D0116	402/750	Anod Plata
20079	S D0116	402/750	Anod Inox
20076	M D0117	562/1200	Anod Plata
19386	M D0117	562/1200	Anod nox
20078	L D0248	816/1600	Anod Plata
20080	L D0248	816/1600	Anod Inox



## MAGICUBE

### Oscilo con bisagras ocultas

#### Oscilobatiente MAGICUBE / BLANDA

CODIGO	REF.	MEDIDA	COLOR
20085	S R-D0209	422/800	Anod Plata dcha
20086	S L-D0240	422/800	Anod Plata izq
20087	S R-D0209	422/800	Anod Inox dcha
20088	S L-D0240	422/800	Anod Inox izq
20093	L R-D0213	700/1700	Anod Plata dcha
20094	L L-D0241	700/1700	Anod Plata izq
20095	L R-D0213	700/1700	Anod Inox dcha
20096	L L-D0241	700/1700	Anod Inox izq



4

#### Juego bisagras 2ª hoja 130 kgs

CODIGO	REF.	COLOR	
19749	D0126.AN	Anod. plata	10
19750	D0126.PI	Anod. inox	10



#### Bisagra 2ª hoja GALICUBE

CODIGO	REF.		
■ 17294	1204R	derecha	10
■ 17295	1204L	izquierda	10



#### Pasador inferior GALICUBE

CODIGO	REF.	
■ 13433	1504B	10

1504B 1500A



#### Pasador superior GALICUBE

CODIGO	REF.		
■ 12554	1500A	215mm	50
■ 12555	1500B	400mm	50



#### Juego pasadores 2ª hoja

CODIGO	REF.		
14960	1503A	superior	10
15224	1503B	inferior	10

#### Cerradero sup metalico

CODIGO	REF.	
19336	4135A	50



#### Cerradero inferior metálico

CODIGO	REF.	
20532	4135B	50



#### Microventilacion

CODIGO	REF.	
14147	1618	1



4

### Manilla Multifunción.

CODIGO	REF.	COLOR	
20034	D0067	Anod Plata	10
19387	D0067	Anod Inox	10

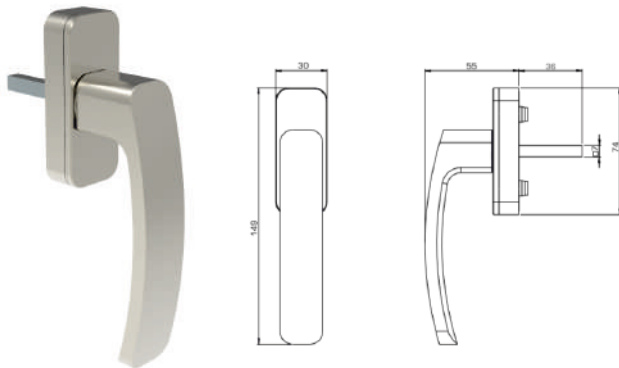

### Manilla Multifunción con llave.

CODIGO	REF.	COLOR	
17715	D0114	Anod Plata	1
15602	D0114	Anod Inox	1

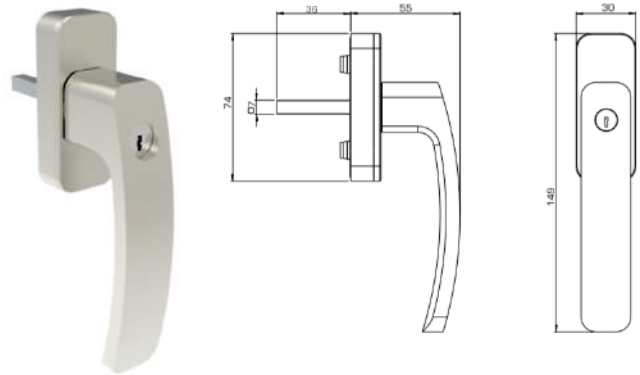

**NOTA:** Para hacer la manilla doble utilizar el tornillo y la tuerca pag. 105.

### Cremona practicable.

CODIGO	REF.	COLOR	COLOR	
20037	R-D0060	Anod Plata	Derecha	10
20038	R-D0060	Anod Inox	Derecha	10

### Kit conexión izquierda

CODIGO	REF.	
18837	D0113	10

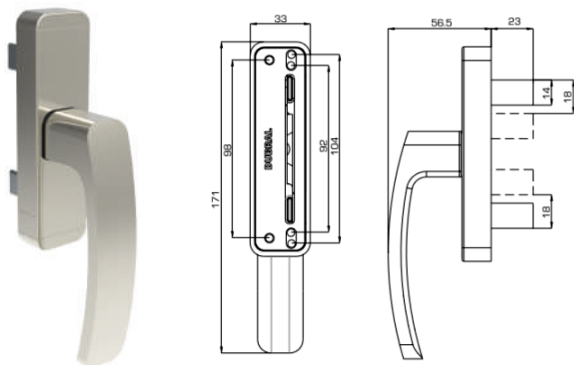

### Cremona apertura exterior.

CODIGO	REF.	COLOR	COLOR	
21051	R-D0167	Anod Plata	Derecha	1
21350	R-D0167	Anod Inox	Derecha	1

### Kit conexión izquierda

CODIGO	REF.	
18837	D0113	1

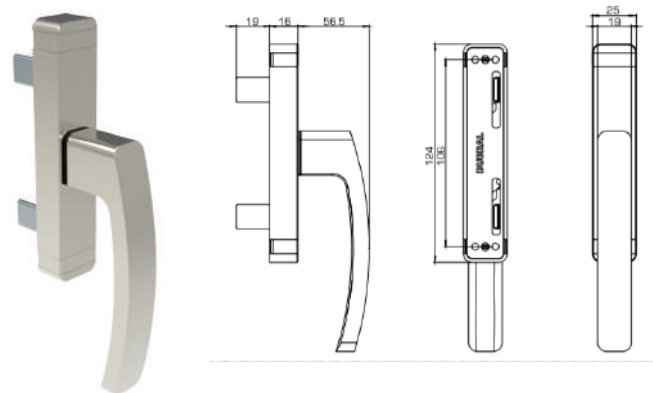

## Manilla recuperable doble.

CODIGO	REF.	COLOR	
20041	D0064	Anod Plata	10
19389	D0064	Anod Inox	10

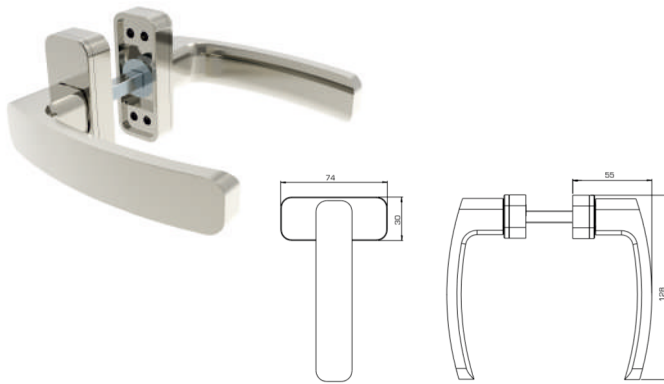

## Embellecedor bombillo

CODIGO	REF.	COLOR	
20046	D0070	Anod Plata	25
19388	D0070	Anod Inox	25

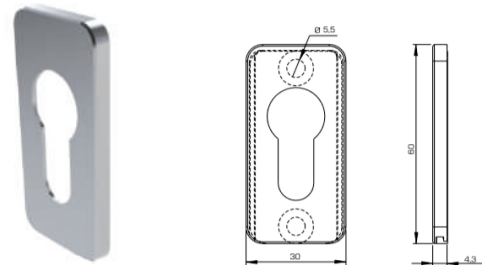

4

## Manilla elevable.

CODIGO	REF.	COLOR	
20049	D0164	Anod Plata	10
20051	D0164	Anod Inox	10

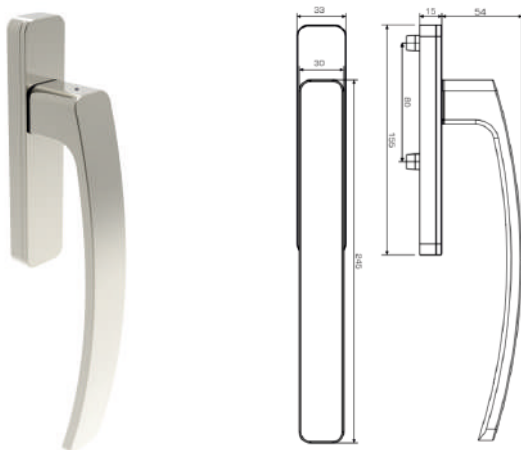

## Manilla elevable doble con agujero para cilindro.

CODIGO	REF.	COLOR	
20141	D0169	Anod Plata	1
20142	D0169	Anod Inox	1

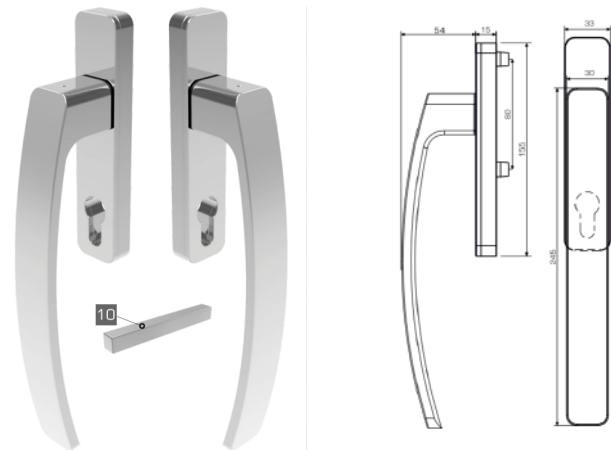

## Uñero Elevable.

CODIGO	REF.	COLOR	
20054	D0166	Anod Plata	10
20055	D0166	Anod Inox	10



**NOTA:** Disponemos de expositores de la linea BLANDA, código ■ 19329.

# STAC

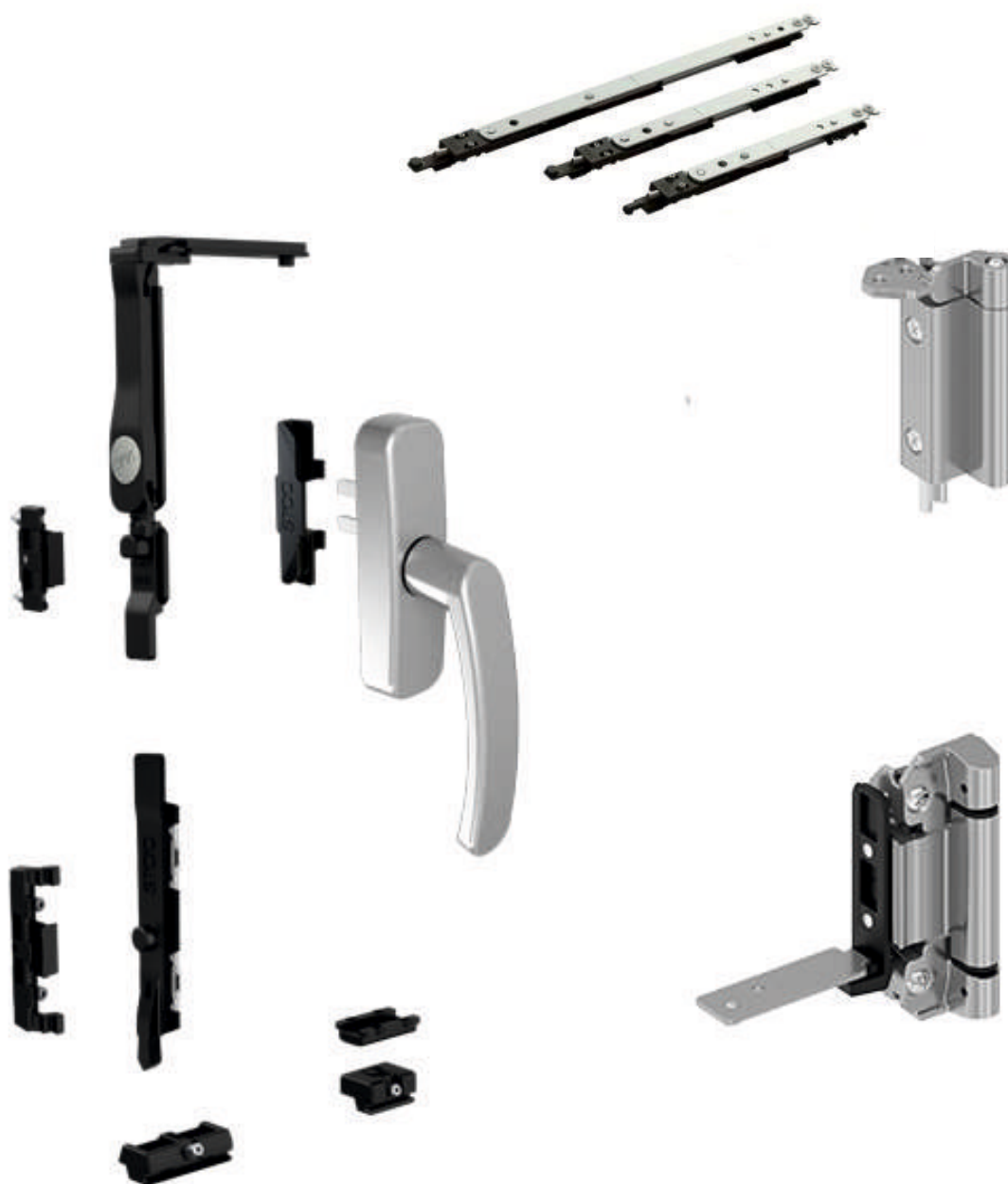

**120 KG**

**Altura mínima: 450 mm**

## Oscilobatiente completo SIRIUS

CODIGO	REF.	MEDIDA	COLOR		CODIGO	REF.	MEDIDA	COLOR	
■ 21035	1118	345/700	Blanco	MICRO	■ 20640	1118	442/750	Blanco	MIDI
■ 21036	1118	345/700	Negro		■ 20641	1118	442/750	Negro	
■ 21037	1118	345/700	Lac Plata		■ 20643	1118	442/750	Lac Plata	
■ 21038	1118	345/700	Lac Inox		■ 20642	1118	442/750	Lac Inox	
■ 20636	1118	372/700	Blanco	MINI (no ángulo de reenvío)	■ 20644	1118	570/1200	Blanco	MAXI
■ 20637	1118	372/700	Negro		■ 20645	1118	570/1200	Negro	
■ 20639	1118	372/700	Lac Plata		■ 20647	1118	570/1200	Lac Plata	
■ 20638	1118	372/700	Lac Inox		■ 20646	1118	570/1200	Lac Inox	



	L min	L max	H min	H max	X	Kg Max.	
<b>MICRO</b>	345	700	450	2600	110	120	L - 309
<b>MINI</b>	372	700	450	1200	120	120	L - 335
<b>MIDI</b>	442	750	500	2600	138	120	L - 373
<b>MAXI</b>	570	1200	700	2600	183	120	L - 495

## Juego bisagra 2ª hoja de 3 cuerpos regulable (con falso compás)

CODIGO	REF.	COLOR	
■ 20649	B111401	Blanco	20
■ 20650	B111402	Negro	20
■ 20652	B111491	Lac Plata	20
■ 20651	B111493	Lac Inox	20



## Pasador 2ª hoja palanca bidireccional

CODIGO	REF.	
■ 20622	111601	20

## Pasador 2ª hoja palanca (altura mínima 665mm)

CODIGO	REF.	
■ 20934	111600	20

## Pasador 2ª hoja aluminio (altura mínima 620mm)

CODIGO	REF.	
20896	112000	20



## Mecanismo unidireccional con tope a 90º

CODIGO	REF.	
■ 20623	0507063	1



## Manilla Multifunción POLARIS

CODIGO	REF.	COLOR	
21518	S577101	Blanco	25
21519	S577102	Negro	25
21520	S577191	Lac Plata	25
21521	S577193	Lac Inox	25

## Ángulo extra de reenvío

CODIGO	REF.	
20621	112100	20



## Compás suplementario 910/1500

CODIGO	REF.	
20620	130301	20



**NOTA:** Utilizar el compás suplementario a partir de 1200mm. de ancho junto con el compás MAXI.

## Pletina falleba poliamida

CODIGO	REF.	
21527	059233	250

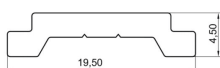

## Punto de cierre 6mm

CODIGO	REF.	
21526	0511149	50



## Cerradero regulable

CODIGO	REF.	
20899	110200	20

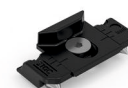

## Cerradero microventilación

CODIGO	REF.	
10619	114401	100







**80 KG**

**Ancho de hoja: 305 a 415mm**

**Oscilo mini OS-150**

CODIGO	REF.	COLOR	
■ 7749	OS 150	Lac Blanco	1
■ 6328	OS 150	Lac Negro	1



**Pasador 2ª hoja**

CODIGO	REF.	
■ 4941	PS0018STR	1







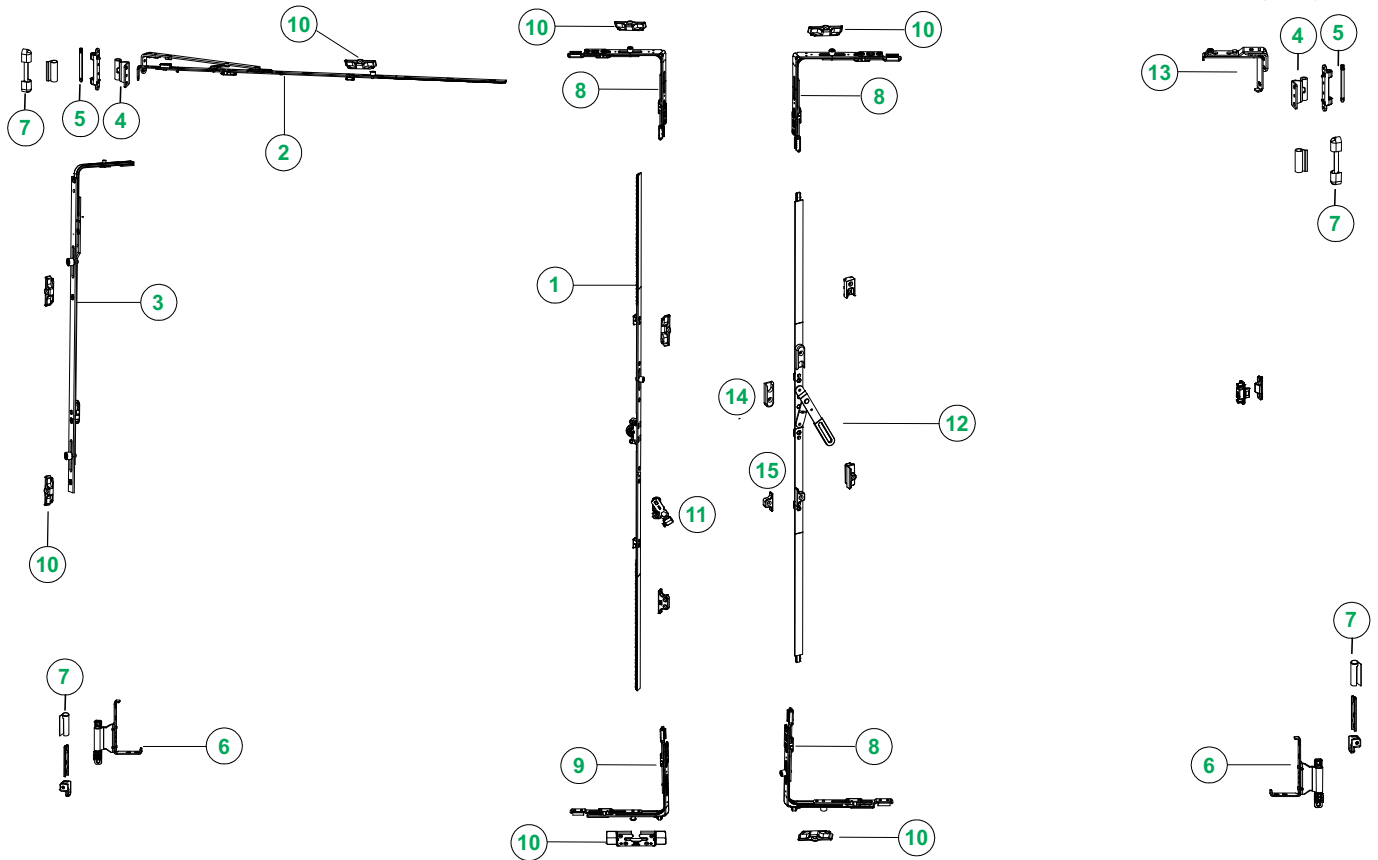

4



	CODIGO	REF.	DESCRIPCIÓN PRODUCTO
1	12189	P59088	Falleba 480-750
	11948	P59069	Falleba 750-1250
	11957	P59070	Falleba 950-1450
	11987	P59071	Falleba 1400-1900
	12001	P59072	Falleba 1900-2400
2	14996	P60001	Compas 400-650
	14997	P60003	Compas 600-850
	15067	P60004	Compas 850-1100
	15069	P6005	Compas 1100-1350
	15068	P0006	Compas 1350-1600
3	14991	P61088	Tirante 0-750
	14992	P61089	Tirante 750-1450
	14993	P61090	Tirante 1400-1900
	14994	P61091	Tirante 1900-2400
4	14798	P60011	Bisagra superior hoja
5	11969	P55006	Bisagra superior marco
6	12005	P53023	Bisagra inferior a canal derecha
	12006	P53024	Bisagra inferior a canal izquierda
7	--	--	Tapas bisagra

	CODIGO	REF.	DESCRIPCIÓN PRODUCTO
8	11952	P52008	Angulo estandar 160x160
	12306	P52009	Angulo seguridad 160x160
	12627	P52006	Angulo pequeño seguridad 160x50
9	11951	P52020	Angulo basculamiento inferior
10	----	----	Cerraderos
11	12307	P58042	Antifalsa maniobra sin elevador de hoja
12	12190	P65013	Cremona palanca 480-750
	11955	P65017	Cremona palanca 750-1250
	11956	P65018	Cremona palanca 950-1450
	11949	P65019	Cremona palanca 1400-1900
	11874	P65020	Cremona palanca 1900-2400
13	14995	P66020	Falso compas
14	11961	P67004	Cerradero cremona palanca
15	18706	P67003	Cerradero antifalsa maniobra nº 11

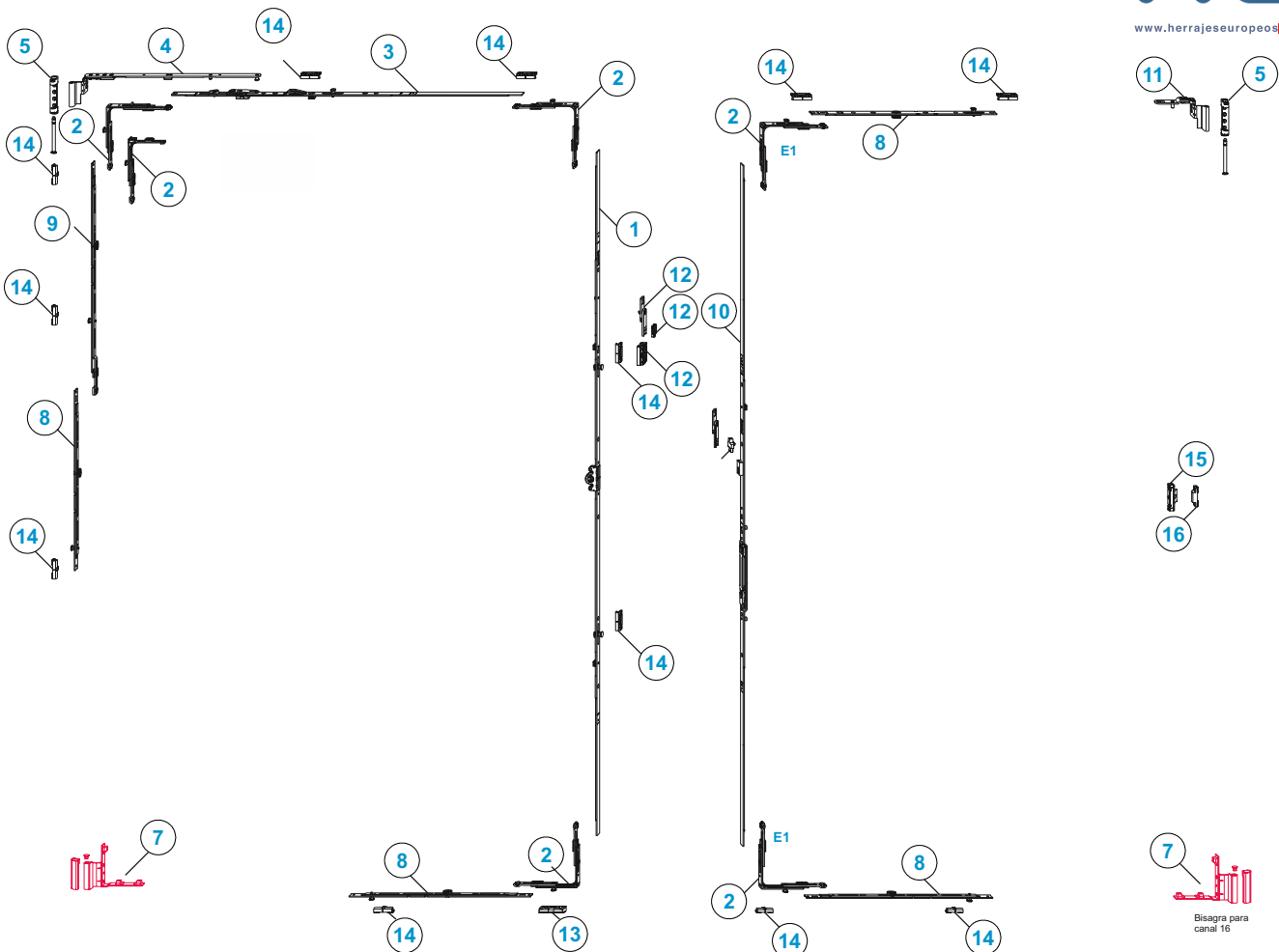

4



	CODIGO	REF.	DESCRIPCIÓN PRODUCTO
<b>1</b>	23607	GAM.800	Falleba 510-800
	23608	GAM.1050-1	Falleba 710-1050
	23609	GAM.1400-1	Falleba 900-1400
	23610	GAM.1800-2	Falleba 1300-1800
	23612	GAM.2300-3	Falleba 1800-2300
<b>2</b>	23618	E1	Angulo grande (superior / inferior)
	23619	E2	Angulo compás grande
	23620	E3	Angulo compás pequeño
<b>3</b>	23703	OS1.600	Rail superior 370-600
	23704	OS2.800	Rail superior 600-800
	23705	OS2.1025-1	Rail superior 775-1025
	23706	OS2.1250-1	Rail superior 1000-1250
	23707	OS2.1475-1	Rail superior 1225-1475
<b>4</b>	23644	SK1.20-13 RS	Compas derecha (hasta 600)
	23645	SK1.20-13 LS	Compas izquierda (hasta 600)
	23648	SK2.20-13 RS	Compas derecha (601-1725)
	23649	SK2.20-13 LS	Compas izquierda (601-1725)
<b>5</b>	23670	SL.KS.3-6	Bisagra superior marco
<b>6</b>	23621	ESV 6-3-16 SL	Bisagra inferior marco
<b>7</b>	23632	FWV 20-13	Bisagra inferior hoja izda / decha
	23633		

	CODIGO	REF.	DESCRIPCIÓN PRODUCTO
<b>8</b>	23680	M.250-1	Cierre central no prolongable
	23682	M.500-1	Cierre central no prolongable
	23684	M.750-1	Cierre central no prolongable
<b>9</b>	23685	MK.250-1	Cierre central prolongable
	23687	MK.500-1	Cierre central prolongable
	23686	MK.750-1	Cierre central prolongable
<b>10</b>	23613	GASM.GZ.800 E3	Cremona palanca 530-800
	23614	GASM.GZ.1050-1	Cremona palanca 710-1050
	23615	GASM.GZ.1400-1	Cremona palanca 900-1400
	23616	GASM.GZ.1800-2	Cremona palanca 1300-1800
<b>11</b>	23617	GASM.GZ.2300-3	Cremona palanca 1800-2300
	23676	DL.K.ET20-13	Falso compás derecha
<b>12</b>	23677	DL.K.ET20-13	Falso compás izquierda
	23693	FSA 13	Falsa maniobra
	23694	TFE	Elemento Trifunción
	-----	-----	Cerradero Trifunción
<b>13</b>	-----	SBK	Cerradero basculamiento inferior
<b>14</b>	-----	SBA	Cerradero standar
<b>15</b>	23691	ZV-FT SL	Bisagra oculta hoja
<b>16</b>	-----	ZV-RT	Bisagra oculta marco

## Kit micro ventilación practicable apertura 180°.

### Linea TRADICIONAL

CODIGO	COLOR	
7067	Blanco	1
7068	Negro	1

### Linea CUADRO

CODIGO	COLOR
24715	Blanco
24272	Negro
24716	Plata
24717	Inox

- El kit micro ventilación permite una posición en la cremona para la ventilación separando el marco y la hoja unos milímetros permitiendo la entrada de aire.
- Fácil instalación.
- El kit queda completamente oculto

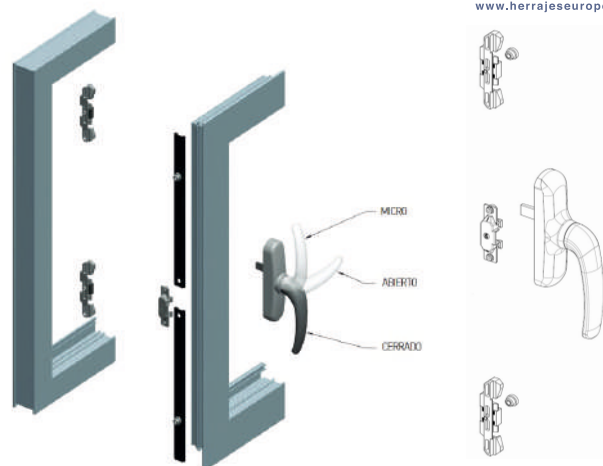

### Cremona oscilo tradicional

CODIGO	REF.	COLOR	
1027	7101	Blanco	12
1028	7101	Negro	12

### Cremona oscilo CUADRO

CODIGO	REF.	COLOR	
22298	5120	Blanco	12
22299	5120	Negro	12
22300	5120	Lac Plata	12
22302	5120	Lac Inox	12

### Kit micro ventilación practicable.

CODIGO	REF.	
7348	33527	150

### Empalme cremona.

CODIGO	REF.	
6034	0B0-401	250

**NOTA:** Se necesitan 2 kits micro ventilación por hoja

## Compás LIMITE. Dispositivo de bloqueo reversible con apertura derecha e izquierda.

CODIGO	REF.	
16865	1456	10

### Cremona NEFER lógica con llave.

CODIGO	REF.	COLOR	
16861	0762BZ	Blanco	10
16946	0762BZ	Negro	10

A	B
50	120
60	110
70	100
80	90

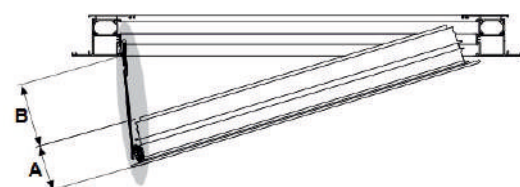

### Ángulo reenvío.

CODIGO	REF.	
21365	---	50

### Empalme cremona.

CODIGO	REF.	
13431	1559A	50

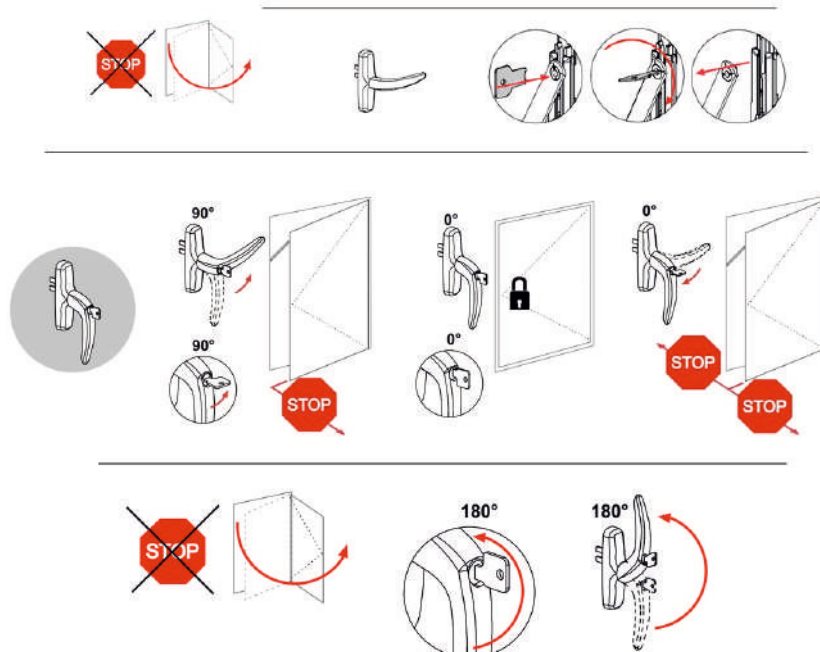
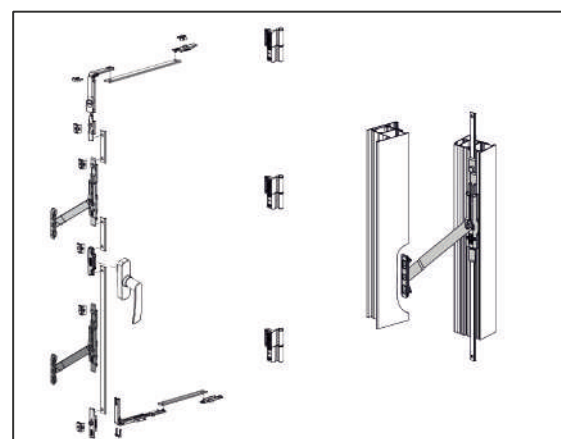
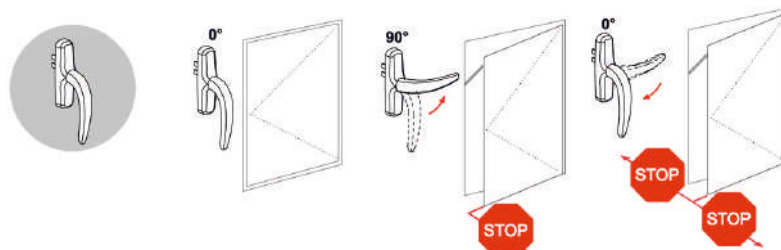

**NOTA:** Para puertas se recomienda la colocación de dos compases.

## Bisagra 2 hojas doble cuerpo, platina inox y eje inox.

CODIGO	REF.	COLOR	MANO	
1246	1070.1	Blanco	Derecha	50
1316	1070.1	Blanco	Izquierda	50
1248	1070.1	Negro	Derecha	50
1318	1070.1	Negro	Izquierda	50
10369	1070.1	Plata anod	Derecha	50
10370	1070.1	Plata anod	Izquierda	50
11113	1070.1	Plata lac	Derecha	50
11023	1070.1	Plata lac	Izquierda	50
1247	1070.1	Inox anod	Derecha	50
1317	1070.1	Inox anod	Izquierda	50

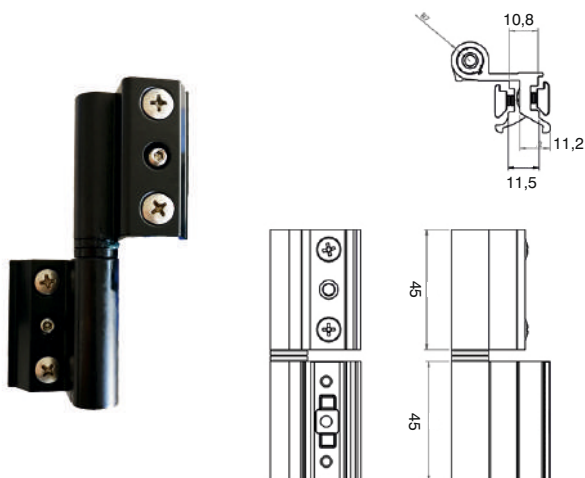

## Bisagra dos hojas doble cuerpo con eje inox. TOP RAPID (80 kgs)

CODIGO	REF.	COLOR	MANO	
6783	9211.23	Blanco	Derecha	50
6784	9211.23	Blanco	Izquierda	50
6786	9211.23	Negro	Derecha	50
6785	9211.23	Negro	Izquierda	50
14443	9211.23	Lac Plata	Derecha	50
14444	9211.23	Lac Plata	Izquierda	50
8024	9211.23	Lac Inox	Derecha	50
8025	9211.23	Lac Inox	Izquierda	50

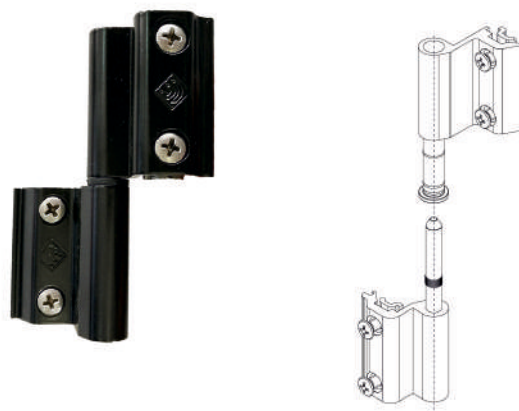

5

## Bisagra Carina regulable CE.

CODIGO	REF.	COLOR	MANO	
24482	023D01R	Blanco	Derecha	50
24483	023I01R	Blanco	Izquierda	50
24466	023D02R	Negro	Derecha	50
24467	023I02R	Negro	Izquierda	50

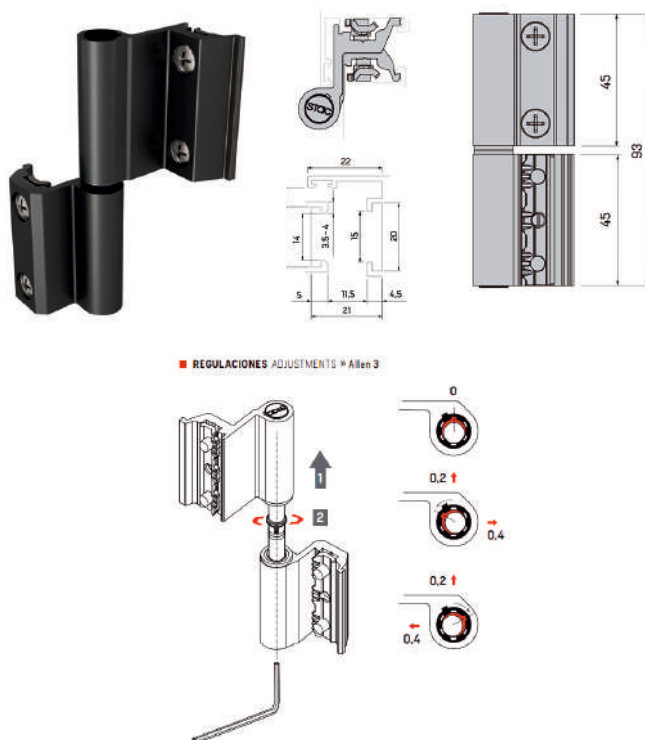

## Bisagra tripla CE, platina aluminio y eje inox.

CODIGO	REF.	COLOR	
600	428	Blanco	25
278	428	Negro	25
17911	428	Lac Plata	25
17805	428	Lac Inox	25

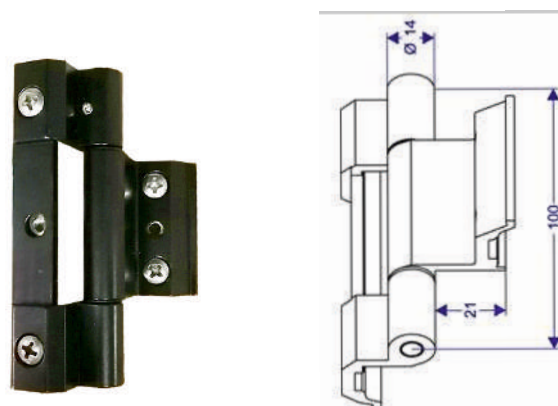

## Bisagra 3ª hoja doble cuerpo, platina inox y eje inox

CODIGO	REF.	COLOR	MANO	
■ 4991	1075.1	Blanco	Derecha	50
■ 4992	1075.1	Blanco	Izquierda	50
■ 4994	1075.1	Negro	Derecha	50
■ 4993	1075.1	Negro	Izquierda	50
■ 1269	1075.1	Plata anod	Derecha	50
■ 1333	1075.1	Plata anod	Izquierda	50
■ 8045	1075.1	Plata lac	Derecha	50
■ 8046	1075.1	Plata lac	Izquierda	50
■ 1267	1075.1	Inox anod	Derecha	50
■ 1331	1075.1	Inox anod	Izquierda	50

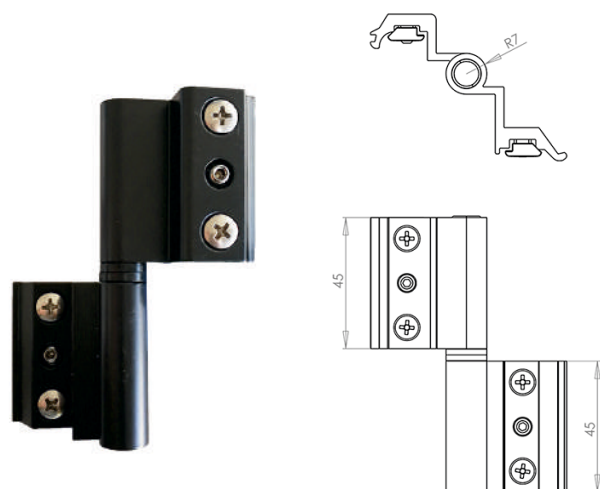

## Bisagra 4ª hoja doble cuerpo, platina zamak y eje inox

CODIGO	REF.	COLOR	MANO	
■ 0339	1090	Blanco	Derecha	20
■ 1346	1090	Blanco	Izquierda	20
■ 0348	1090	Negro	Derecha	20
■ 1347	1090	Negro	Izquierda	20

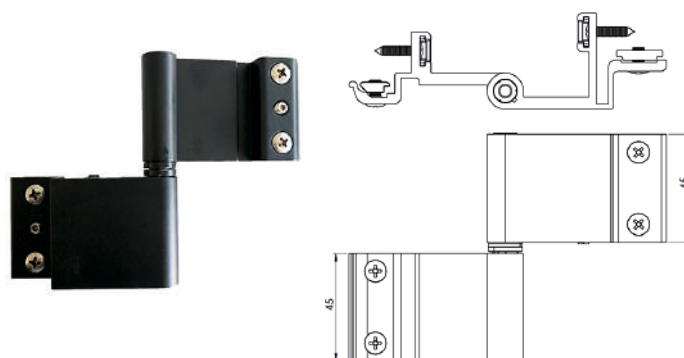

5

## Bisagra 4ª hoja triple cuerpo, platina de zamak, eje inox

CODIGO	REF.	COLOR	
■ 1292	1090.1	Blanco	10
■ 1294	1090.1	Negro	10
■ 1295	1090.1	Plata anod	10
■ 1293	1090.1	Inox anod	10



## Bisagra 4ª hoja CE VENICE BABY, platina zamak, eje inox

CODIGO	REF.	COLOR	
■ 14709	5603Q	Blanco	20
■ 13848	5603Q	Negro	20
■ 14984	5603Q	Anod Plata	20
■ 14986	5603Q	Lac Inox	20

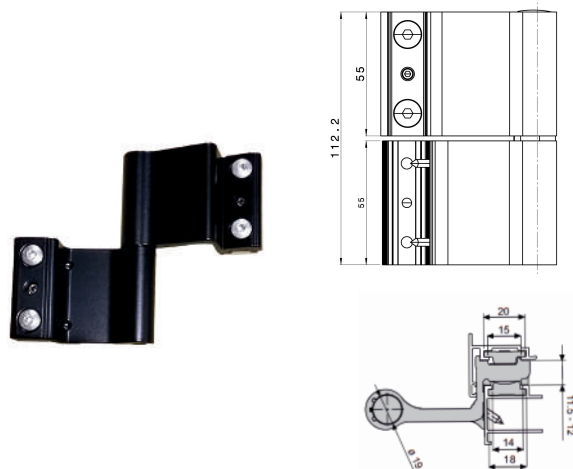



## Bisagra doble cuerpo con eje inox. SLIM RAPID 140mm (120 kgs)

CODIGO	REF.	COLOR	
■ 2355	8060	Blanco	20
■ 2395	8060	Negro	20
■ 7894	8060	Lac Plata	20
■ 9809	8060	Lac Inox	20

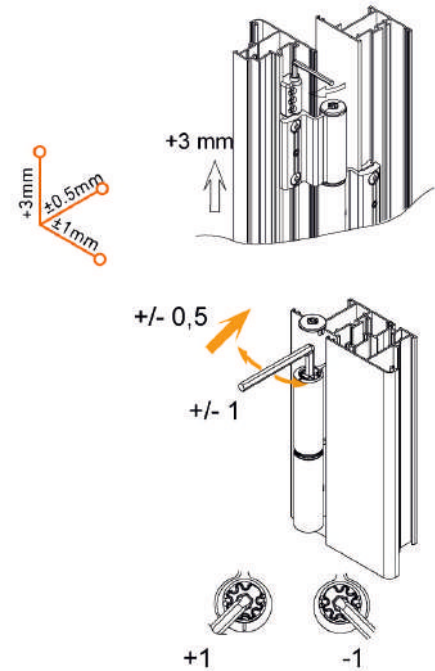
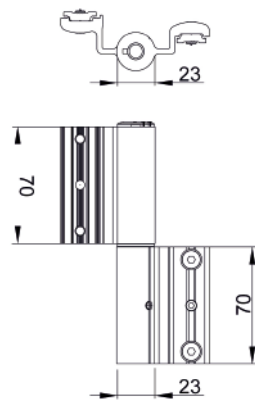

5

## Bisagra doble cuerpo con eje inox puerta 110mm (80 kgs).

CODIGO	REF.	COLOR	
21985	2500	Blanco	20
21986	2500	Negro	20
21987	2500	Lac Plata	20
21988	2500	Lac Inox	20

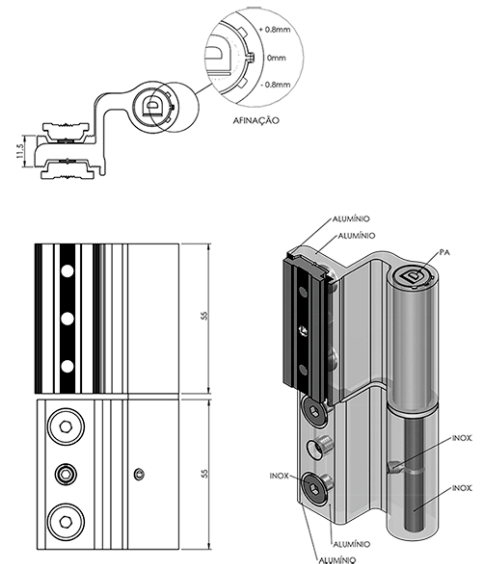

## Bisagra tripla para puerta eje inox 197mm (160 kgs)

CODIGO	REF.	COLOR	
21026	7100 SPEC	Blanco	6
21027	7100 SPEC	Negro	6
21028	7100 SPEC	Lac Plata	6
21029	7100 SPEC	Lac Inox	6

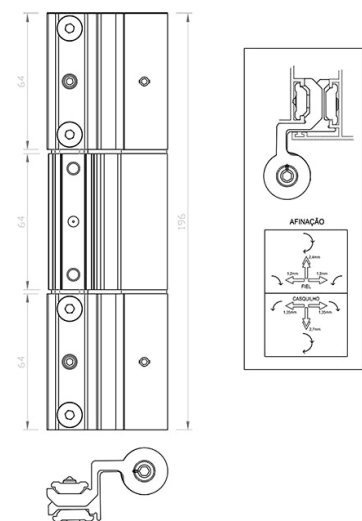

**NOTA:** El peso de las bisagras puede verse reducido en función de la medida de la puerta y el número de bisagras. En caso de duda solicitar ficha técnica.

## Bisagra 2 hojas doble cuerpo, platina zamak eje inox con prisionero.

CODIGO	REF.	COLOR	MANO	
3269	5031	Blanco	Derecha	50
3280	5031	Blanco	Izquierda	50
1790	5031	Negro	Derecha	50
1087	5031	Negro	Izquierda	50

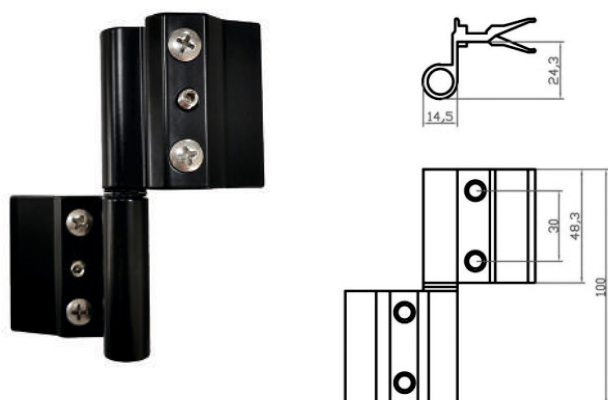

## Bisagra 2 hojas doble cuerpo, platina zamak eje zincado con prisionero.

CODIGO	REF.	COLOR	MANO	
9183	5031	Blanco	Derecha	50
114	5031	Blanco	Izquierda	50
9185	5031	Negro	Derecha	50
9184	5031	Negro	Izquierda	50

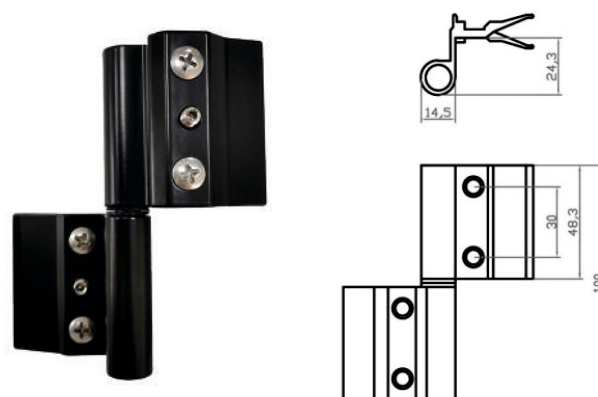

5

## Bisagra 2 hojas doble cuerpo, platina zamak eje zincado

CODIGO	REF.	COLOR	MANO	
1226	1060.2	Blanco	Derecha	25
1303	1060.2	Blanco	Izquierda	
1227	1060.2	Negro	Derecha	Eje inox
1304	1060.2	Negro	Izquierda	
7780	1060.2	Plata anod	Derecha	Eje inox
7781	1060.2	Plata anod	Izquierda	
1223	1060.1	Inox anod	Derecha	Eje inox
1300	1060.1	Inox anod	Izquierda	

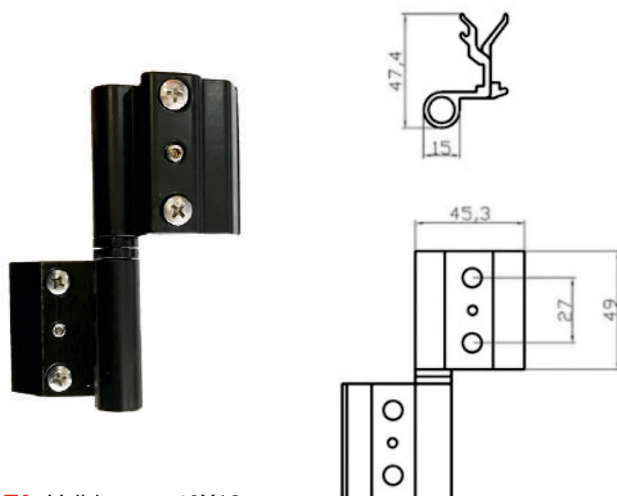

## Bisagra tripla 4020, platina zamak eje zincado.

CODIGO	REF.	COLOR	
1229	1060.3	Blanco	100
1231	1060.3	Negro	100

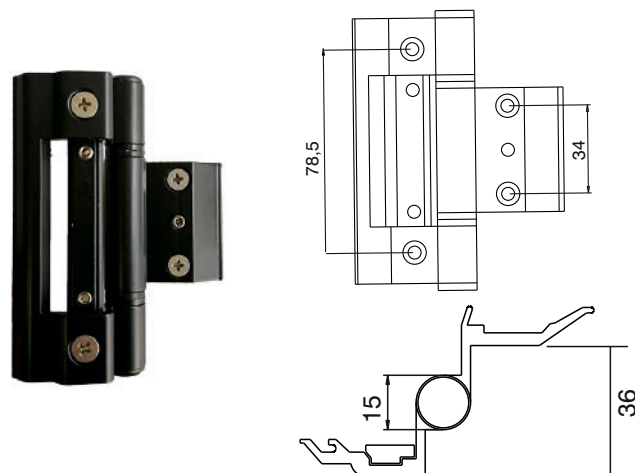

**NOTA:** Valida para 40X18



## Bisagra 3 hojas doble cuerpo, platina zamak eje inox.

CODIGO	REF.	COLOR	MANO	
102	5031	Blanco	Derecha	25
9766	5031	Blanco	Izquierda	25
103	5031	Negro	Derecha	25
9767	5031	Negro	Izquierda	25

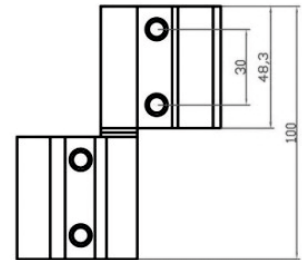
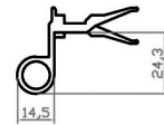

5

## Bisagra 4ª hoja doble cuerpo y eje inox.

CODIGO	REF.	COLOR	MANO	
1281	1080	Blanco	Derecha	25
1341	1080	Blanco	Izquierda	25
1282	1080	Negro	Derecha	25
1342	1080	Negro	Izquierda	25

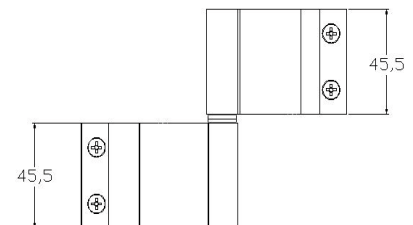
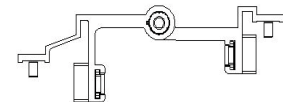
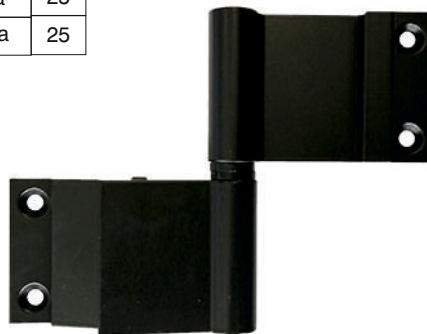

## Bisagra 4ª hoja triple cuerpo y eje inox.

CODIGO	REF.	COLOR	
1283	1080.1	Blanco	25
1285	1080.1	Negro	25
1286	1080.1	Plata anod	25
1284	1080.1	Inox anod	25

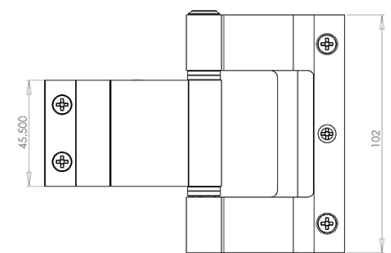
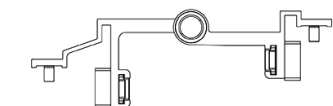
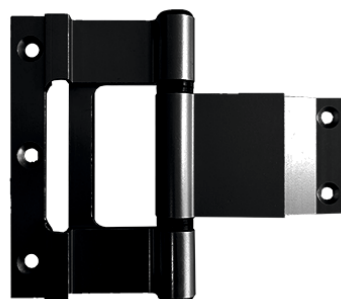

## Bisagra para doble hoja (postigo o porticon)

CODIGO	REF.	COLOR	
■ 2619	600	Blanco	50
■ 2620	600	Negro	50
19177	2004	Lac Plata	52
18996	2004	Lac inox	52

**NOTA:** Cierre especial para postigo o porticon ver pag.139.  
**600**

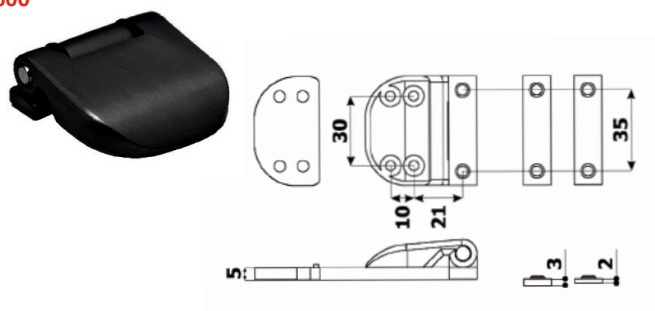

**2004**

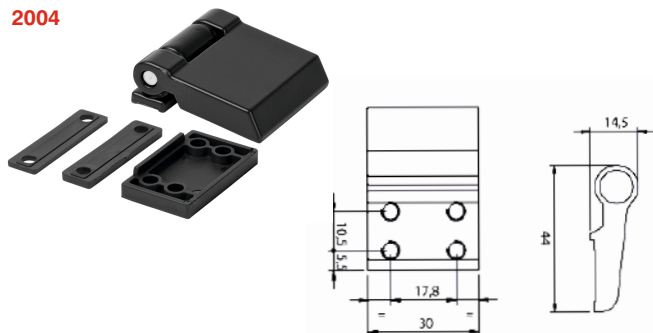

## Bisagra para perfiles planos (tubo + tubo)

CODIGO	REF.	COLOR	A	
4470	DIVISORIA	Blanco	105mm	50
4471	DIVISORIA	Negro	105mm	50
6760	DIVISORIA	Plata anod	105mm	50
■ 16610	DIVISORIA	Inox anod	105mm	50
■ 9501	DIVISORIA PUERTA	Blanco	155mm	50
■ 9502	DIVISORIA PUERTA	Negro	155mm	50
■ 11407	DIVISORIA PUERTA	Plata anod	155mm	50

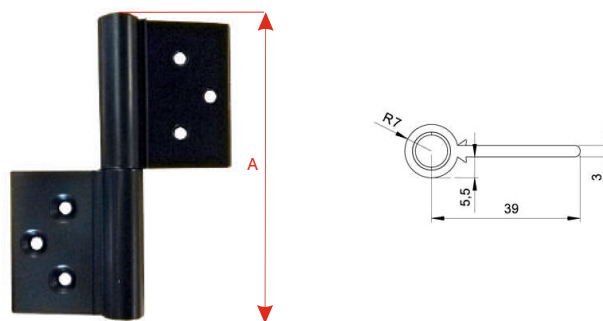

5

## Bisagra Canal centrado 2ª y 3ª hoja

CODIGO	REF.	COLOR	MANO	
■ 3985	1040.4	Blanco	Derecha	50
■ 4051	1040.4	Blanco	Izquierda	50
■ 3973	1040.4	Negro	Derecha	50
■ 4050	1040.4	Negro	Izquierda	50
■ 7733	1040.4	Lac plata	Derecha	50
■ 7732	1040.4	Lac plata	Izquierda	50
■ 3996	1040.4	Lac Inox	Derecha	50
■ 4058	1040.4	Lac Inox	Izquierda	50



## Bisagra 4ª canal centrado

CODIGO	REF.	COLOR	
■ 5507	1040.5	Blanco	20
■ 5508	1040.5	Negro	20
■ 10300	1040.5	Lac Plata	20
■ 10301	1040.5	Lac Inox	20



## Bisagra doble cuerpo con eje inox NEW BIG especial para rotura de puente térmico (Peso 120 kgs).

CODIGO	REF.	COLOR
16218	8000C	Blanco
16219	8000C	Negro
16502	8000C	Lac Plata
16503	8000C	Lac Inox

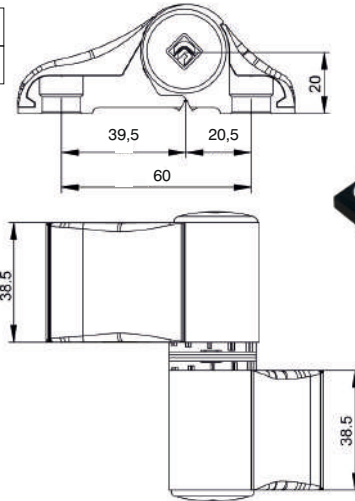

### Suplemento 7mm para perfil sin rotura.

CODIGO	REF.	COLOR	
16220	8010C.5	Blanco	2
16221	8010C.5	Negro	2
16504	8010C.5	Lac Plata	2
16505	8010C.5	Lac Inox	2

### Suplemento 7mm para perfil con rotura.

CODIGO	REF.	COLOR	
20196	8010C.25	Blanco	10
20199	8010C.25	Negro	10
20200	8010C.25	Lac Plata	10
20198	8010C.25	Lac Inox	10



### Plantilla para bisagra 8000

CODIGO	REF.	
13029	8000.20	1

### Kit fijación para perfiles con rotura

CODIGO	REF.	A	B - C	D	
16495	8010.13	≥ 43 mm	≤ 31,5 mm	53 mm	2
16496	8010.14	≥ 58 mm	≤ 46,5 mm	68 mm	2

8010.13

8010.14



### Kit fijación para perfiles sin rotura

CODIGO	REF.	
16222	8010.17	2



8010.17

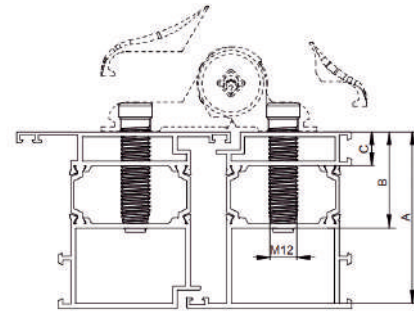

## Bisagra de vaivén. Bisagra en perfil de aluminio con muelle de recuperación.

CODIGO	REF.	COLOR	
285	VAIVEN	Blanco	12
286	VAIVEN	Negro	12
8068	VAIVEN	Anod Plata	12
10597	VAIVEN	Lac inox	12

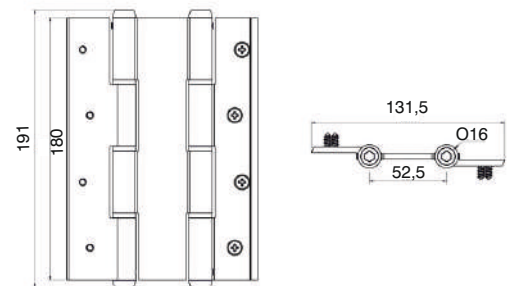

## Bisagra pivotante para CE y 4020

CODIGO	REF.	COLOR		
156	5069	BLANCO	10	CE
157	5069	NEGRO	10	
96	5039	BLANCO	10	4020
97	5039	NEGRO	10	



Para CE ref.5069



Para 40x20 ref.5039

## Kit 1ª hoja de nylon para CE con puntera regulable.

CODIGO	REF.	
■ 2452	Kc20510	50



## Kit 2ª hoja de nylon para CE con puntera regulable.

CODIGO	REF.	
■ 2454	Kc20510	50



**NOTA:** Para canal 18 utilizar el código 11353

## Kit 1ª hoja metálico CE.

CODIGO	REF.	
■ 2428	612	40



## Kit cierre 2ª hoja metálico CE.

CODIGO	REF.	
■ 2426	609	30

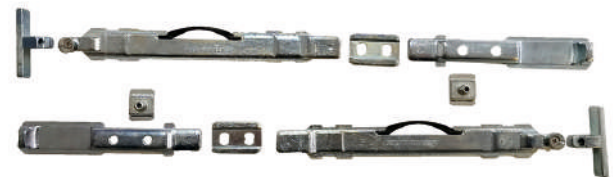

## Kit para apertura exterior 1ª hoja.

CODIGO	REF.	
■ 3574	612-1	40

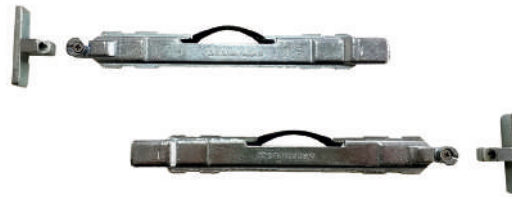

## Kit para la 2ª hoja metálico. (Para hojas sin marco inferior)

CODIGO	REF.	
■ 4154	-----	30



## Kit para la 2ª hoja nylon. (Para hojas sin marco inferior)

CODIGO	REF.	
■ 5851	4011.55	25



## Pasador SIRIO 2ª hoja C20 para CE con puntera regulable.

CODIGO	REF.	
■ 4780	4011.20 (SIRIO)	50

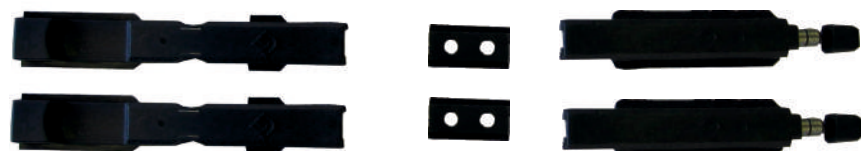

## Pasador 2ª hoja C20 con cerradero.

CODIGO	REF.	COLOR
634	9200 (140mm)	Blanco
635	9200 (140mm)	Negro
632	9200 (215mm)	Blanco
633	9200 (215mm)	Negro
630	9200 (260mm)	Blanco
631	9200 (260mm)	Negro

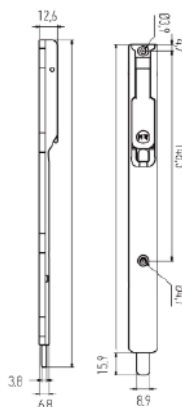

## Cierre 2ª hoja con palanca regulable.

CODIGO	REF.	Icono
13754	7000	10

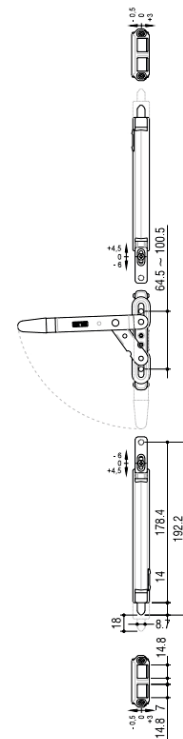

## Pasador TITANDUE

CODIGO	REF.	COLOR	MEDIDA
18916	3720AZ2	Negro	145mm
16731	3720CZ2	Negro	220mm
16732	05240302	Negro	440mm



05240302

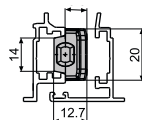
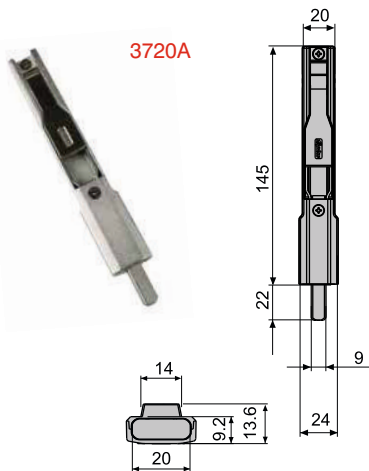

Art. 3720C



**NOTA:**  
Utilizar el cerradero suelo codigo 13380



## Pasador 2ª hoja metálico CE (solo pulsador).

CODIGO	REF.	
19178	4514.2	10



## Puntera CE

CODIGO	REF.	
3013	510	200

**NOTA:** Empalme cremona nylon código 9326.



## Puntera especial mallorquina

CODIGO	REF.	
7743	A4032.20B	200

**NOTA:**  
Utilizar el cerradero suelo código 6571



## Cerradero 3º punto simple.

CODIGO	REF.		
568	504	Nylon	200
569	504 (ALTO 12mm)	Nylon	200
5521	4214 (largo)	Nylon	100
2623	180	Zamac	100

504

504 (ALTO 12mm)

4214 (largo)

180



## Cerradero simple

CODIGO	REF.	
4951	611	1



## Cerradero doble.

CODIGO	REF.	CARACTERISTICAS	
563	504	Nylon	200
7444	OBT21	Metálico Regulable	10

504

OBT21



## 3º punto y cerraderos

CODIGO	REF.	
6570	4246	50
12406	15971	100



## Cierre de 3º punto regulable terminal.

CODIGO	REF.	
753	604-2	100



CODIGO	REF.	
6254	2008	50

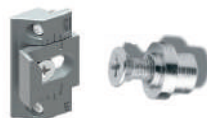

## Cierre de 3º punto regulable intermedio.

CODIGO	REF.	
6565	3520.32	1

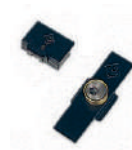

## Cierre 3º punto especial para 4214 largo

CODIGO	REF.	
17175	1596c	50



## Clip retenedor metálico

CODIGO	REF.	
18380	534	25



## Cierre adicional antielevación (antipalanca)

CODIGO	REF.	
18989	1636A	1



## Cerradero antipolvo para puertas.

CODIGO	REF.	∅	
6571	4234	8 mm	50
1685	631	10 mm	50



## Patin apoyo hoja

CODIGO	REF.	
2183	6100	1





## Kit 1ª hoja apertura exterior, canal 28 (Puntera metálica).

CODIGO	REF.	
2476	N1	100



## Kit 1ª hoja apertura interior, canal 28 (puntera metálica).

CODIGO	REF.	
2478	N2	100

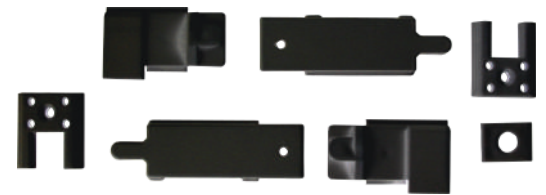

## Kit de dos hojas apertura interior, canal 28 (puntera mixta).

CODIGO	REF.	
2480	N3	100

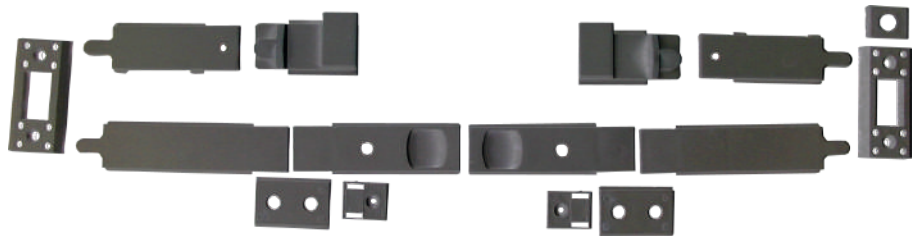

## Kit de dos hojas apertura exterior, canal 28 (puntera mixta).

CODIGO	REF.	
2482	N4	100

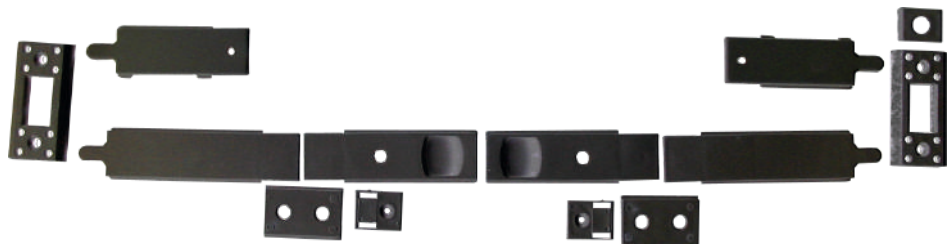

## Tercer punto de cierre, canal 28.

CODIGO	DESCRIPCION	
567	Cerradero simple	1
565	Cerradero doble	1
3554	Tapa cerradero	1



## Puntera metálica.

CODIGO	REF.	
3012	N6	50



## Kit 2ª hoja s/6000 plástico, canal 28.

CODIGO	REF.	
2464	126/124	100

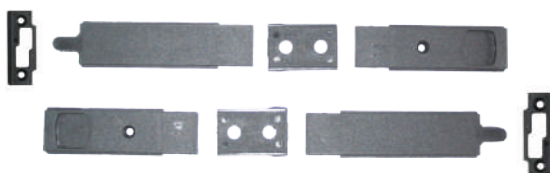

## Clip retenedor 40x20

CODIGO	REF.	
2019	K-12962-00-0-1	1





## Pasadores con puntera de Inox.

CODIGO	REF.	COLOR
7250	4504.8 - 140	Blanco
7251	4504.8 - 140	Negro
7248	4501.8 - 220	Blanco
7249	4501.8 - 220	Negro



**NOTA:**  
Utilizar el cerradero suelo código 6571

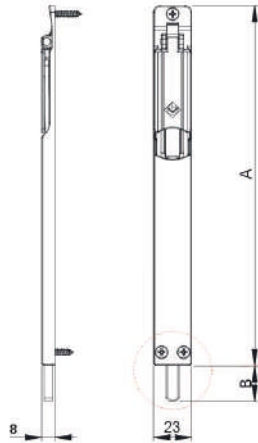

96

## Pasador de apoyo (extraplano)

CODIGO	REF.	COLOR	MEDIDA
12433	3712	Blanco	150mm
6285	3712	Negro	150mm
■ 14669	3713	Blanco	440mm
■ 14670	3713	Negro	440mm

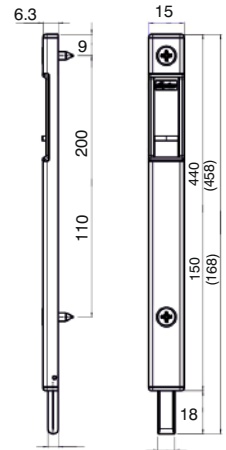

5

# Cerrojos

## Cerrojo. (varilla de 8 mm) INOX Cerrojo normal, puente alto

CÓDIGO	REF.	COLOR	MEDIDAS	
■ 9316	318AI	Blanco	50	47
■ 9420		Negro		
■ 461	320AI	Blanco	100	97
■ 893		Negro		
■ 9983	323AI	Blanco	200	197
■ 7690		Negro		
6347	325AI	Blanco	300	297
4172		Negro		

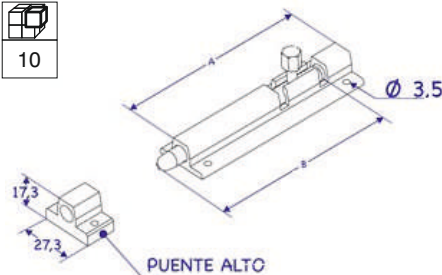

## Puente cerrojo bajo (varilla de 8 mm)

CÓDIGO	COLOR
■ 17204	Blanco
■ 17206	Negro



## Cerrojo. (varilla de 12mm) INOX Cerrojo normal, puente alto

CÓDIGO	REF.	COLOR	MEDIDAS	
12155	360AI	Blanco	100	97
12156		Negro		
12159	363AI	Blanco	200	197
12160		Negro		
6377	365AI	Blanco	300	297
12083		Negro		

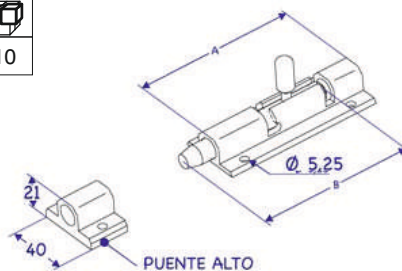

## Puente cerrojo bajo (varilla de 12 mm)

CÓDIGO	COLOR
19183	Blanco
19184	Negro

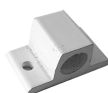

**NOTA:** Para medidas no estandarizadas, consultar. Medida máxima a fabricar 1000 mm.

## Cremona Marte para apertura exterior con dos palas regulables. Disponible con palas de de 37mm, 42mm y 57mm.

CODIGO	REF.	COLOR	MANO	LONGITUD
■ 2635	329	Blanco	Derecha	Pala de 37mm
2646	329	Blanco	Izquierda	
■ 2636	329	Negro	Derecha	
2647	329	Negro	Izquierda	
■ 2641	329	Lac Plata	Derecha	Pala de 42mm
■ 2637	328	Blanco		
■ 2638	328	Negro		Pala de 57,4mm
5725	328L	Blanco		
5726	328L	Negro		

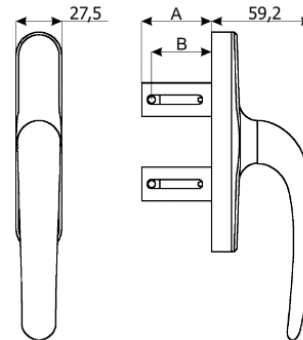
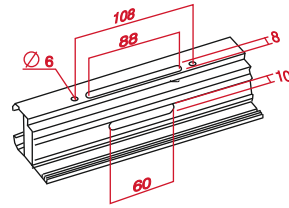

Art.	A	B
328	41,5	≤ 35,5
329	38	≤ 32
328L	57	≤ 51

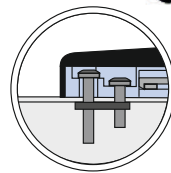

montaje en perfil

5

## Cremona Marte con llaves iguales, 2 palas regulables.

CODIGO	REF.	COLOR	A
■ 7873	329 - CYL	Blanco	Pala de 37mm
■ 7874	329 - CYL	Negro	
7875	328 - CYL	Blanco	Pala de 42mm
7876	328 - CYL	Negro	
9504	328L - CYL	Blanco	Pala de 57,4mm
9335	328L - CYL	Negro	

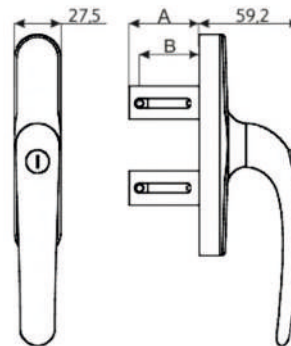

Art.	Pattini	A(mm)	B(mm)
328 CV	Versione standard	41,5	35,5 max
329 CV	Versione corta	38	32 max
328L CV	Versione lunga	57	51 max

## Cremona Marte plana, 2 palas regulables.

CODIGO	REF.	COLOR	A
■ 7882	329 - PLANA	Blanco	Pala de 37mm
■ 7883	329 - PLANA	Negro	
7879	328 - PLANA	Blanco	Pala de 42mm
7880	328 - PLANA	Negro	
■ 9505	328L - PLANA	Blanco	Pala de 57,4mm
■ 9506	328L - PLANA	Negro	

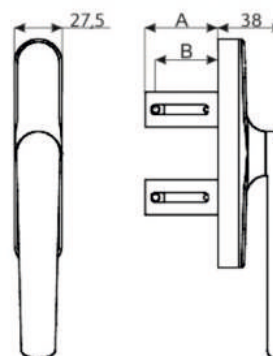

Art.	Pattini	A(mm)	B(mm)
328 MR	Versione standard	41,5	35,5 max
329 MR	Versione corta	38	32 max
328L MR	Versione lunga	57	51 max

## Perno INOX de transmision a pletina falleba (m-5).

CODIGO	A	TIPO
2950	8 mm	Inox
2947	15 mm	Inox
■ 2948	22 mm	Inox
■ 2949	26 mm	Inox



## Perno CINCADO de transmision a pletina falleba (m-5).

CODIGO	A	TIPO
2684	8 mm	Cincado
2686	15 mm	Cincado
■ 2687	22 mm	Cincado
■ 2688	26 mm	Cincado
■ 5692	30 mm	Cincado

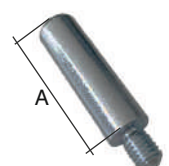

## Cremona 2 palas plana.

CODIGO	REF.	COLOR	
7654	6027.10	Blanco	20
7653	6027.10	Negro	20

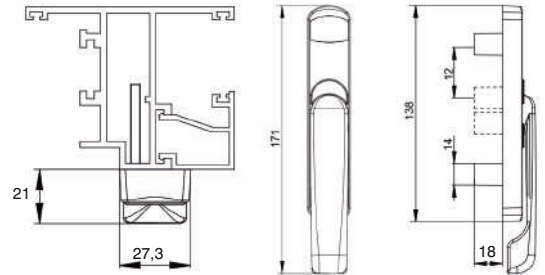

## Cierre doble acción 215

CODIGO	REF.	COLOR	
14967	215	Blanco	10
14968	215	Negro	10

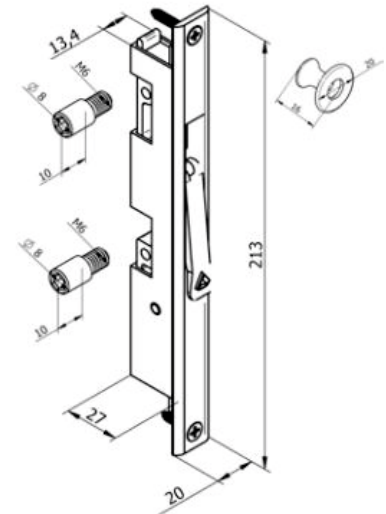

## Pomo para cierre 215

CODIGO	REF.	COLOR	
14971	215-T	Blanco	10
14970	215-T	Negro	10

## Bulones para cierre 215

CODIGO	
14969	10

5

## Kit apertura exterior nylon

CODIGO	REF.	
2155	3200	75

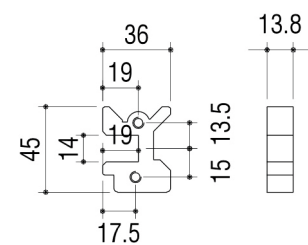

## Kit extensor apertura exterior.

CODIGO	PERNIOS	MEDIDA	
3048	16mm	34 mm	50
2336	23mm	34 mm	50

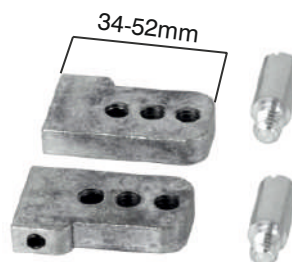

CODIGO	REF.	PERNIOS	MEDIDA	
5017	619-1	16,22 y 26mm	52 mm	50

“Fast Out” Multipunto INOX para puerta apertura exterior.

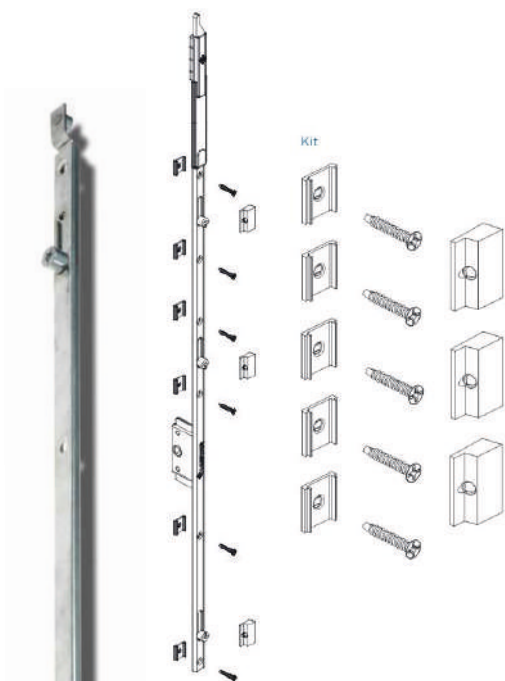

CODIGO	REF.	LARGO	ALTURA MANILLA	PUNTOS DE CIERRE	ENTRADA	
8909	6151.2	600mm	250mm	2	30mm	4
5831	6153.2	1000mm	260mm	3		
■ 7845	6155.3	1600mm	800mm	3		
8800	6161.2	600mm	250mm	2	35mm	4
9182	6163.2	1000mm	260mm	3		
■ 8108	6165.2	1600mm	800mm	3		

### Kit anclaje

CODIGO	REF.	LARGO	PUNTOS DE CIERRE	
5899	6151.1	600mm	2	24
5835	6153.1	1000mm	3	24
■ 7541	6155.1	1600mm	3	24

5

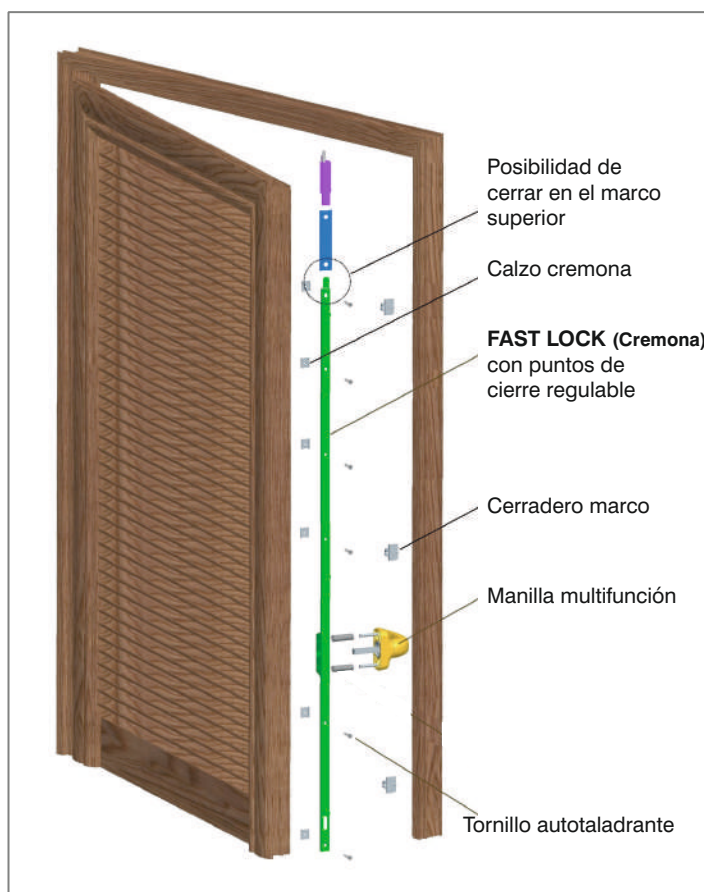
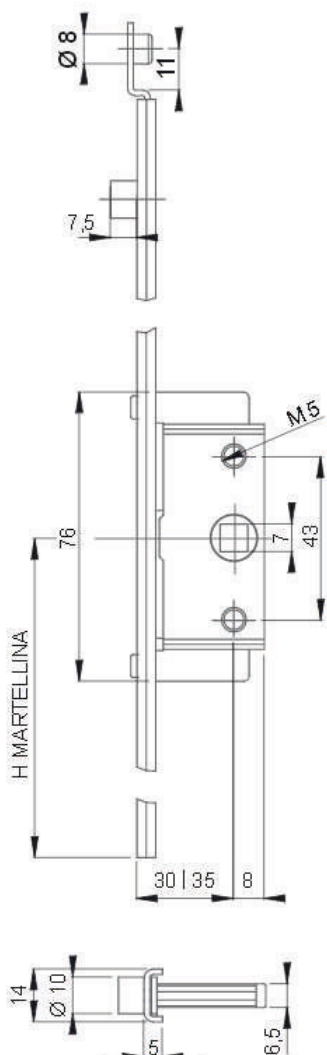

## Caja embutir 90° unidireccional.

CODIGO	REF.	ENTRADA	
6746	6-25948-30-0-1	30 mm	1
3009	6-25948-37-0-1	35 mm	1
6093	6-25948-42-0-1	40 mm	1



## Caja embutir 180° unidireccional.

CODIGO	REF.	ENTRADA	
5487	6-25916-30-0-1	30 mm	1
8163	6-25916-35-0-1	35 mm	1
8398	6-25916-40-0-1	40 mm	1



## Caja con agujero para cilindro unidireccional (solo para la caja de 180°)

CODIGO	REF.	ENTRADA	
6747	6-25918-30-0-1	30 mm	1
4388	6-25918-35-0-1	35 mm	1
7272	6-25918-40-0-1	40 mm	1



## Kit de fijación para doble manilla

CODIGO	REF.	MEDIDA	
4412	K0771-01	65mm	1
19290	K0771-02	85mm	1

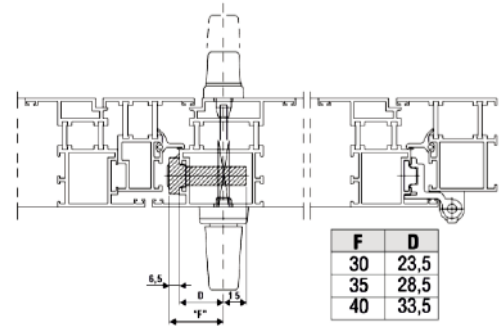
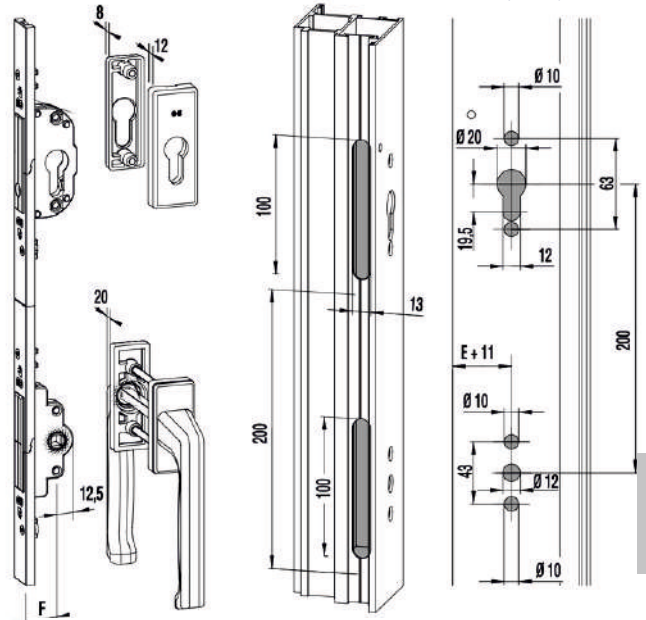

5

## Mecanismo bidireccional regulable.

CODIGO	REF.	REGULACION	
5890	A3626.1	Entrada 15min/25max	20
16525	A3626.2	Entrada 25min/35max	10



## Perno inox M6.

CODIGO	REF.	
6128	P-15	1
2951	P-22	1

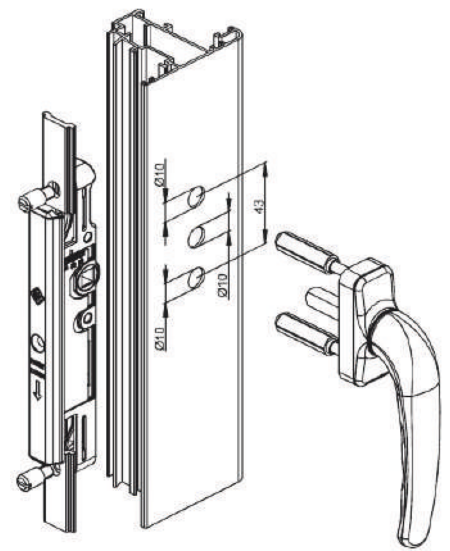

Art. 3626.1

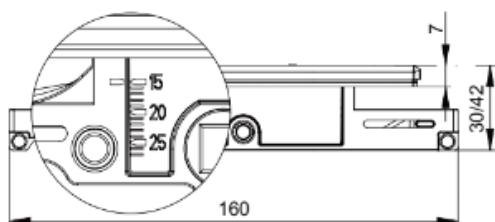

Art. 3626.2

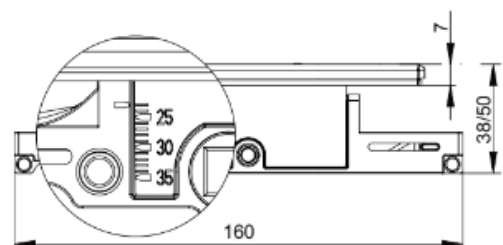



## Compas retenedor

CODIGO	REF.	MEDIDA
869	01	150 mm
872	02	250 mm



Compas 01  
Max. 50 kg

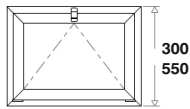

Compas 02  
Max. 50 kg

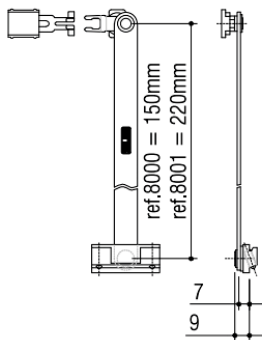
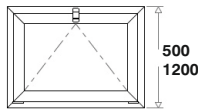

Compas 01  
Max. 50 kg

H	X	Y
300	0	100
350	45	140
450	100	195
550	150	255

Compas 02  
Max. 50 kg

H	X	Y
500	0	170
600	60	215
800	120	285
1000	190	355
1000	275	445

## Compas limitador y retenedor SPEED.

CODIGO	REF.	MEDIDA
15429	SPEED	150 mm
17179	SPEED	220 mm

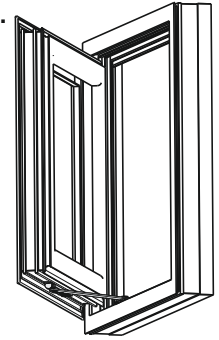

### Sistema de Freno.

El sistema permite graduar la velocidad de apertura de la ventana, mediante la regulación del tornillo.

FREE CLICK

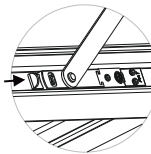

### Sistema Free Click

Permite desbloquear el brazo de la hoja, liberandola para su posterior limpieza.

### Sistema de Retención.

Proporciona un tope suave y retiene la ventana en la posición deseada, evitando cierres accidentales.

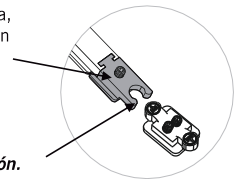

## Compas retenedor con carraca INOX (250mm) (Jgo)

CODIGO	REF.	KGS	Icon
8053	5210 (CE)	80kgs	12

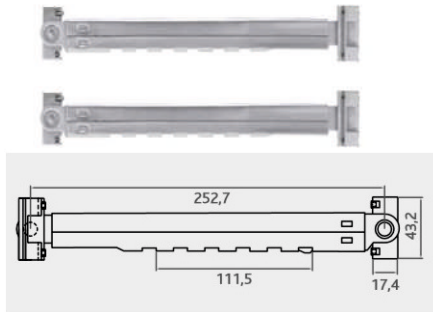

## Compas retenedor con carraca corto CE (185mm)(Jgo).

CODIGO	REF.	KGS	Icon
4732	-----	50kgs	12



## Compas retenedor CE.

CODIGO	REF.	MEDIDA	COLOR	Icon
2113	4002	180	Blanco	25
2114	4002	180	Negro	25
2115	4001	220	Blanco	25
2116	4001	220	Negro	25

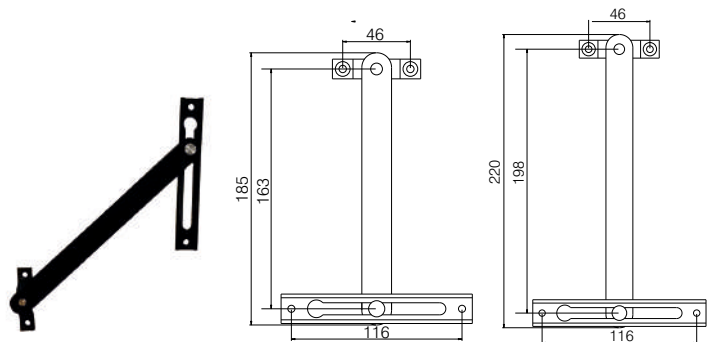

## Cierre golpete CE.

CODIGO	REF.	COLOR	Icon
575	4606	Blanco	50
576	4606	Negro	50



## Cierre golpete CE regulable.

CODIGO	REF.	COLOR	Icon
4884	11216	Blanco	20
4885	11216	Negro	20
5359	11216	Lac Plata	20



## Compas retenedor para 4020.

CODIGO	REF.	MEDIDA	COLOR
880	503TC	125	Blanco
882	503TC	125	Negro

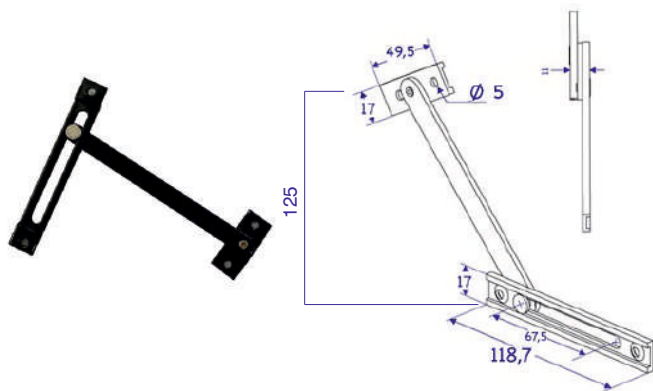
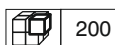

## Compas retenedor con carraca INOX (250mm) (Jgo)

CODIGO	REF.	KGS	Icon
8054	5210 (40x20)	80kgs	12

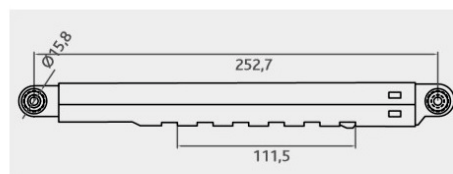

5

## Cierre golpete serie 4000-6000.

CODIGO	REF.	COLOR	Icon
596	606	Blanco	100
598	606	Negro	100



## Cierre golpete serie 4000-6000.

CODIGO	REF.	COLOR	Icon
3246	500	Blanco	100
3407	500	Negro	100





## Compas proyectante para camara europea.

CÓDIGO	REF.	L	Altura hoja min / max	Ancho hoja min / max	COLOR	
6621	D6090.24P	260	450/1800	450/750	Inox	10
6622	D6090.24G	463	450/1200	450/1200	Inox	10

### CARACTERÍSTICAS:

Fácil montaje, gracias al deslizamiento guiado del brazo de la hoja.  
 Permite fijar la apertura deseada gracias al patín de freno.  
 Regulación mediante llave allen de 2.5 mm.  
 Alcanza una apertura de 50° en el pequeño y 80° en el grande.  
 Viene con seis calzos de apoyo y una galga de coloración para su perfecto asiento en el marco de la ventana.  
 Realizado en acero inoxidable y brazo en aluminio anodizado.  
 Peso máximo 25Kg (el juego)  
 Altura mínima de hoja 360 mm en el pequeño y 500 mm el grande.



### COMPAS 260

	600	700	800	900	1000
360	■	■	■	■	■
400	■	■	■	■	■
450	■	■	■	■	■
514	■	■	■	■	■
600	■	■	■	■	■

### COMPAS 463

	1000	1100	1250	1430	1660	2000
500	■	■	■	■	■	■
600	■	■	■	■	■	■
700	■	■	■	■	■	■
800	■	■	■	■	■	■
900	■	■	■	■	■	■
1000	■	■	■	■	■	■

5

## Compas proyectante EASY RAPID PLUS para CE

CÓDIGO	REF.	L	Altura hoja min / max	Ancho hoja min / max	Tipo de apertura	Kilos	Angulo apertura	
18496	1233.16	418	450/1800	450/750	Practicable	42	30°	5
			450/1200	450/1200	Proyectante	60	30°	5
			450/1200	450/1200	Batiente	60	30°	5

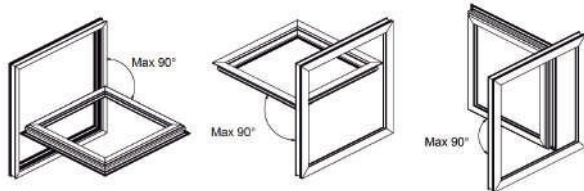

**NOTA:** 90° solo para limpieza y mantenimiento

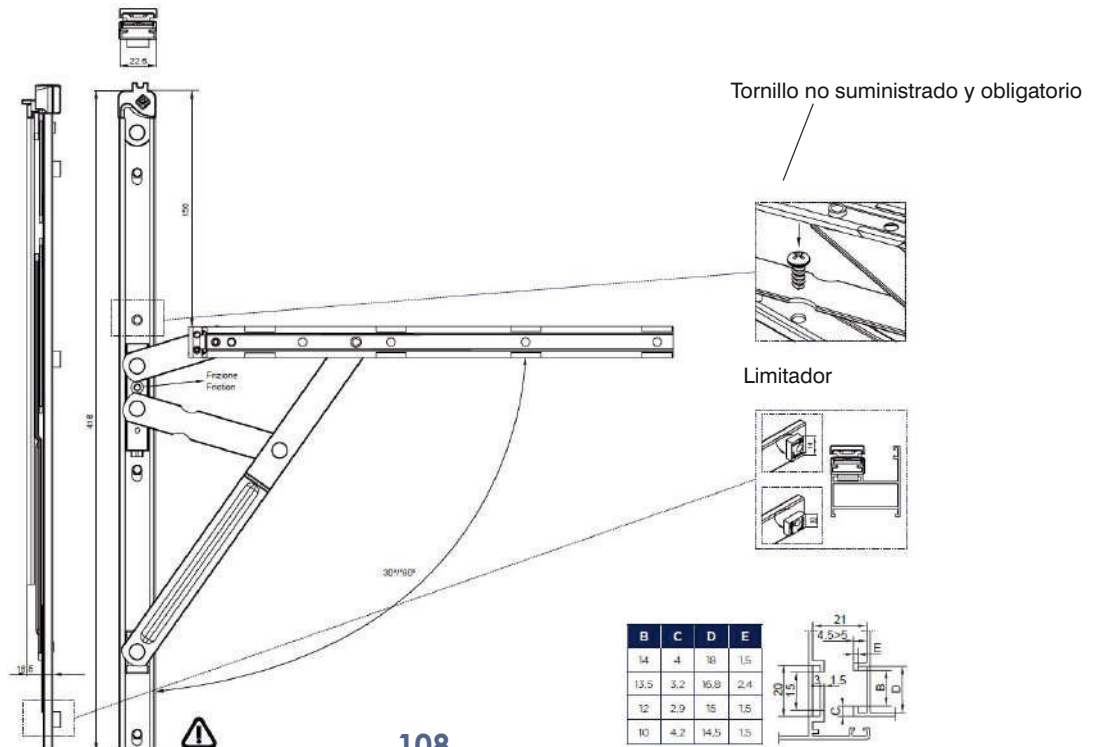

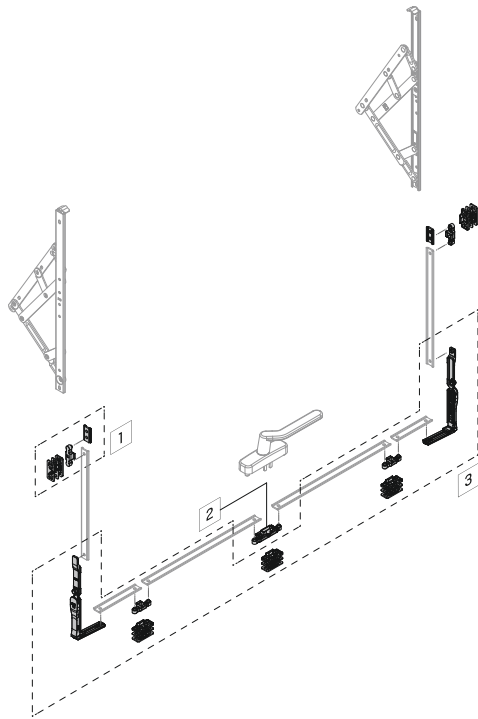

## Juego compases proyectante para 40x20 y Muro Cortina.

CÓDIGO	REF.	L	Peso max hoja (kg)	Altura min hoja (mm)	Altura max hoja (mm)	Angulo (+/- 2.5º)
4139	Tn5013	262	50	262	650	50
4138	Tn5014	413	55/100	413	800	50/30
4137	Tn5015	567	80/100	567	1500	45/20
■ 12726	Tn5016	687	180	687	2500	20
■ 12727	Tn5017	707	100	707	2200	15

## Juego reguladores

CODIGO	REF.	
10000	AP/23	12



INOX NO FERRÍTICO  
AISI 316



5

## Cremona acodada SIRIUS

CODIGO	COLOR	MANO	
25299	Blanco	Derecha	20
25300	Negro	Derecha	20



**NOTA:** Manilla reversible (se puede cambiar de mano).

## Empalme cremona proyectante

CODIGO	REF.	
25301	180100	50



## Kit cierre perimetral proyectante (2 angulos + 3 cerraderos)

CODIGO	REF.	
25302	183500	10



## Cierre para Muro Cortina (incluye el cerradero).

CODIGO	REF.	COLOR	MANO	A	
14404	480	Blanco	Derecha	28,5	24
■ 14407	480	Blanco	Izquierda	28,5	24
14406	480	Negro	Derecha	28,5	24
■ 14405	480	Negro	Izquierda	28,5	24

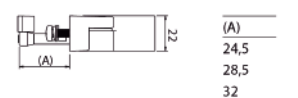
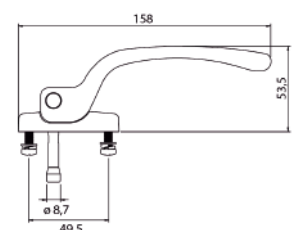

## Punto de cierre adicional regulable

CODIGO	REF.	
25303	183000	50

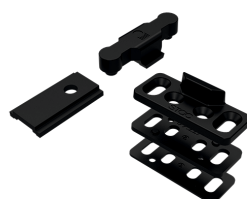

Herraje para pivotante 515.  
Eje de giro horizontal con 4 puntos de cierre.

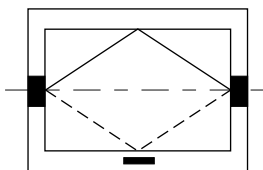
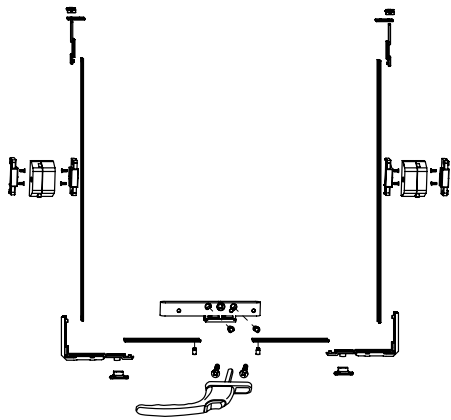

Peso máximo de hoja 130 Kg.  
(Dependiendo del perfil)

Herraje para pivotante 515.  
Eje de giro horizontal con 6 puntos de cierre.

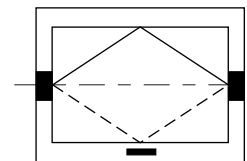
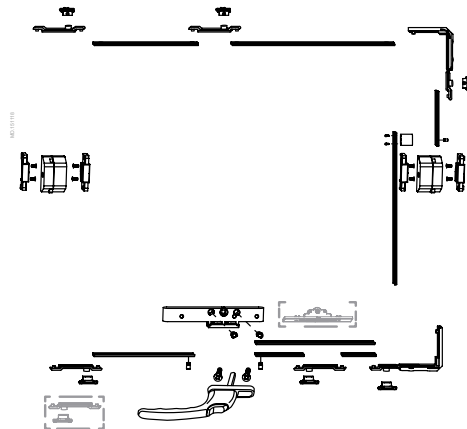

Peso máximo de hoja 130 Kg.  
(Dependiendo del perfil)

6

Herraje para pivotante 515.  
Eje de giro vertical con 6 puntos de cierre.

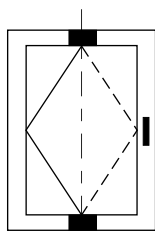
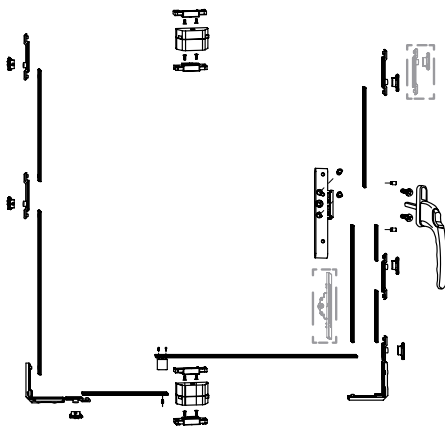

Peso máximo de hoja 130 Kg.  
(Dependiendo del perfil)

Series estudiadas:

PERFIL	SERIE
ALCAR	AE 0931
ALCOA	ALFIL P45
ALCOA	ALFIL P45 RPT
ALUGOM	STILO 60RPT
ALUMED	GP40-45
ALUMED	INSIGNIA
CORTIZO	2000
CORTIZO	3000
CORTIZO	COR 60
EXLABESA	CLASSIC 52 RPT
EXTRUGASA	XP-60 TH
EXTRUAL	E-25
EXTRUAL	E-36
GALISUR	GPR-45
GALISUR	GPR-52
HIDRO ALUM	DOMAL BREAK 52
HIDRO ALUM	DOMAL STOPPER PG
ITESAL	I40
ITESAL	IT-61
LAMINEX	LEX54 RPT
SAPA	Rt7050
SOPENA	V-98
TECALUM	TS 45

\* Anchura y altura máxima de rebajo de la hoja según medidas indicadas por el sistema del perfil.

**NOTA:** En caso de colocar perfil travesaño en vez de inversor rogamos nos lo comuniquen porque lleva un herraje especial.

5

Mecanismo P-70 lama móvil con mando rotary y con las pletinas traseras de aluminio.



Montante P-36

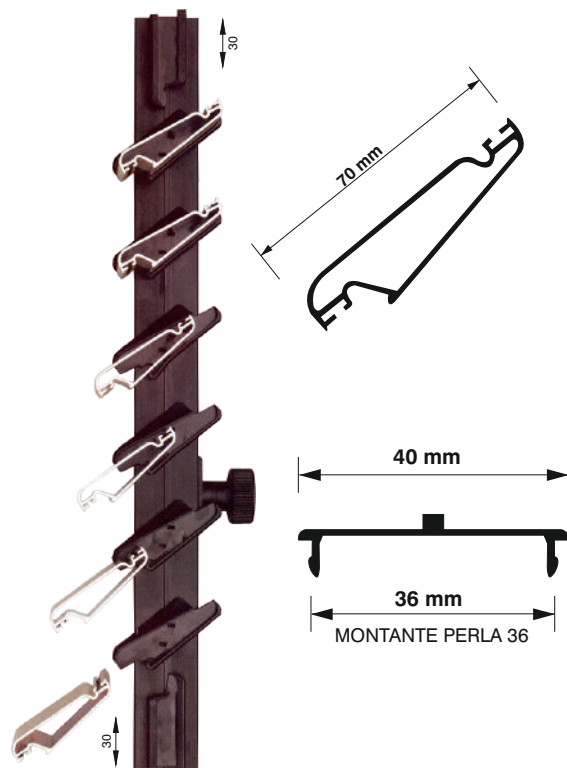

Mando rotary (pomo) inoxidable.

CODIGO	REF.	COLOR	
1813	Rotary	Blanco	10
1814	Rotary	Negro	10



Mando rotary (manivela) inoxidable.

CODIGO	REF.	COLOR	
5985	Manivela	Blanco	10
5178	Manivela	Negro	10



Mando SL,

CODIGO	REF.	COLOR
2813	SL	Negro

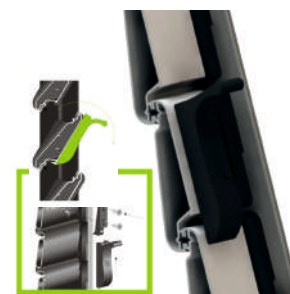

## NEGRO



CODIGO	LAMAS	ALTURA	CODIGO	LAMAS	ALTURA
2834	6 lamas	460 mm	2829	24 lamas	1540 mm
2835	7 lamas	520 mm	2830	25 lamas	1600 mm
2836	8 lamas	580 mm	2831	26 lamas	1660 mm
2837	9 lamas	640 mm	2832	27 lamas	1720 mm
2815	10 lamas	700 mm	2833	28 lamas	1780 mm
2816	11 lamas	760 mm	4196	29 lamas	1840 mm
2817	12 lamas	820 mm	3694	30 lamas	1900 mm
2818	13 lamas	880 mm	5284	31 lamas	1960 mm
2819	14 lamas	940 mm	4491	32 lamas	2020 mm
2820	15 lamas	1000 mm	6449	33 lamas	2080 mm
2821	16 lamas	1060 mm	6450	34 lamas	2140 mm
2822	17 lamas	1120 mm		35 lamas	2200 mm
2823	18 lamas	1180 mm	24454	36 lamas	2260 mm
2824	19 lamas	1240 mm		37 lamas	2320 mm
2825	20 lamas	1300 mm		38 lamas	2380 mm
2826	21 lamas	1360mm		39 lamas	2440 mm
2827	22 lamas	1420 mm		40 lamas	2500 mm
2828	23 lamas	1480 mm			

Mecanismo en largo (barras 3 mts = 50 lamas)

CODIGO	COLOR
5002	Negro

NOTA: para pedir una barra de 3 mts hay que pedir 50 uds

## BLANCO



CODIGO	LAMAS	ALTURA	CODIGO	LAMAS	ALTURA
4404	6 lamas	460 mm	4472	24 lamas	1540 mm
6586	7 lamas	520 mm	6189	25 lamas	1600 mm
4444	8 lamas	580 mm	6190	26 lamas	1660 mm
4554	9 lamas	640 mm	6191	27 lamas	1720 mm
243	10 lamas	700 mm	6192	28 lamas	1780 mm
4327	11 lamas	760 mm	6073	29 lamas	1840 mm
244	12 lamas	820 mm	6193	30 lamas	1900 mm
3389	13 lamas	880 mm	5284	31 lamas	1960 mm
245	14 lamas	940 mm	4294	32 lamas	2020 mm
4295	15 lamas	1000 mm	9043	33 lamas	2080 mm
100	16 lamas	1060 mm	16874	34 lamas	2140 mm
256	17 lamas	1120 mm	18556	35 lamas	2200 mm
4506	18 lamas	1180 mm	7103	36 lamas	2260 mm
2058	19 lamas	1240 mm		37 lamas	2320 mm
257	20 lamas	1300 mm	7104	38 lamas	2380 mm
2591	21 lamas	1360mm		39 lamas	2440 mm
4419	22 lamas	1420 mm		40 lamas	2500 mm
4278	23 lamas	1480 mm			

Mecanismo en largo (barras 3 mts = 50 lamas)

CODIGO	COLOR
16738	Blanco

NOTA: para pedir una barra de 3 mts hay que pedir 50 uds



il Meridiano  
innovative systems

Mecanismo P-70 lama móvil con mando rotary y con las pletinas traseras de aluminio.

Montante P-36

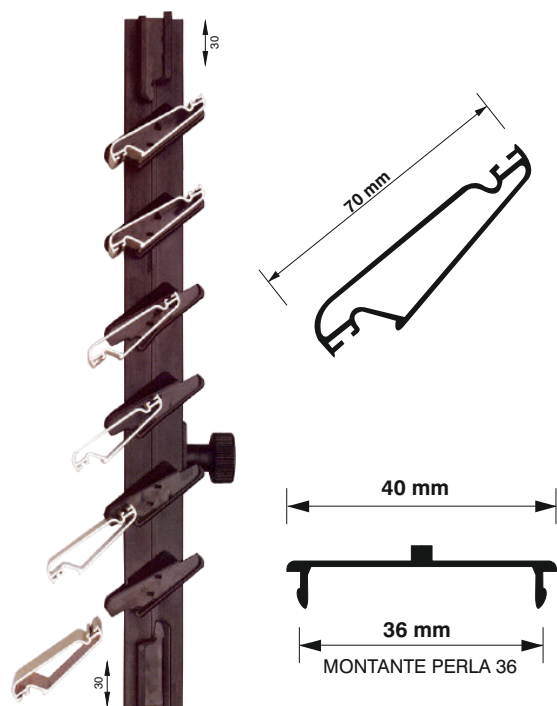

Mando rotary (pomo) zamak.

CODIGO	REF.	COLOR	
16381	197	Blanco	50
9739	197	Negro	50

30mm



Mando rotary (manivela) zamak.

CODIGO	REF.	COLOR	
12101	05	Blanco	50
9738	05	Negro	50

42mm



Mando palanca M992

CODIGO	REF.	COLOR	
15097	M992	BI Dcha	50
15098	M992	Ng Dcha	50
15099	M992	BI Izqda	50
15100	M992	Ng Izqda	50



7

NEGRO



CODIGO	LAMAS	ALTURA	CODIGO	LAMAS	ALTURA
9734	6 lamas	460 mm	9727	24 lamas	1540 mm
9735	7 lamas	520 mm	9728	25 lamas	1600 mm
9736	8 lamas	580 mm	9729	26 lamas	1660 mm
9737	9 lamas	640 mm	9730	27 lamas	1720 mm
9714	10 lamas	700 mm	9731	28 lamas	1780 mm
9715	11 lamas	760 mm	9732	29 lamas	1840mm
9793	12 lamas	820 mm	9733	30 lamas	1900 mm
9716	13 lamas	880 mm	■ 13997	31 lamas	1960mm
9717	14 lamas	940 mm	■ 17018	32 lamas	2020mm
9718	15 lamas	1000 mm		33 lamas	2080mm
9719	16 lamas	1060 mm		34 lamas	2140mm
9720	17 lamas	1120 mm		35 lamas	2200mm
9721	18 lamas	1180 mm		36 lamas	2260mm
9722	19 lamas	1240 mm		37 lamas	2320mm
9723	20 lamas	1300 mm		38 lamas	2380mm
9724	21 lamas	1360mm		39 lamas	2440mm
9725	22 lamas	1420 mm		40 lamas	2500mm
9726	23 lamas	1480 mm			

BLANCO



CODIGO	LAMAS	ALTURA	CODIGO	LAMAS	ALTURA
12424	6 lamas	460 mm	■ 15071	24 lamas	1540 mm
12425	7 lamas	520 mm	■ 19904	25 lamas	1600 mm
10308	8 lamas	580 mm	■ 24158	26 lamas	1660 mm
12426	9 lamas	640 mm		27 lamas	1720 mm
12094	10 lamas	700 mm	■ 23576	28 lamas	1780 mm
12095	11 lamas	760 mm		29 lamas	1840mm
10306	12 lamas	820 mm	■ 17701	30 lamas	1900 mm
10304	13 lamas	880 mm		31 lamas	1960mm
10307	14 lamas	940 mm		32 lamas	2020mm
10305	15 lamas	1000 mm		33 lamas	2080mm
12096	16 lamas	1060 mm		34 lamas	2140mm
12097	17 lamas	1120 mm		35 lamas	2200mm
12098	18 lamas	1180 mm		36 lamas	2260mm
12099	19 lamas	1240 mm		37 lamas	2320mm
12100	20 lamas	1300 mm		38 lamas	2380mm
14279	21 lamas	1360mm		39 lamas	2440mm
14280	22 lamas	1420 mm		40 lamas	2500mm
■ 14281	23 lamas	1480 mm			

Mecanismo en largo  
(barras 3 mts = 50 lamas)

CODIGO	COLOR	
14111	Negro	50

Mecanismo en largo  
(barras 3 mts = 50 lamas)

CODIGO	COLOR	
14337	Blanco	50

**NOTAS:** -Para pedir una barra de 3 metros hay que pedir 50 uds, código 14337 y 14111.  
- A partir de 22 lamas, se recomienda colocar 2 rotarys para su correcto funcionamiento y a partir de 35 es obligatorio poner 2 rotarys.



Mecanismo P-70 lama móvil con palanca.

## Montante P-36

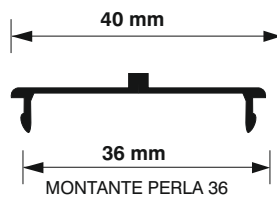
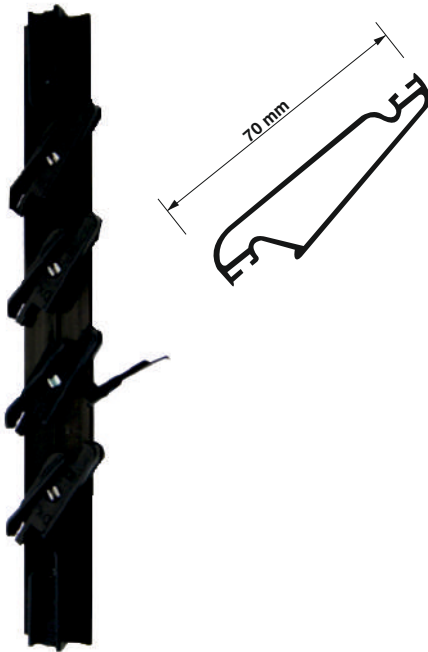

### Jgo Terminal Cortizo

CODIGO	
18646	1



Mecanismos de travesaño (palanca montada en la 3ª lama superior)

P-36				
CODIGO	LAMAS	COLOR	ALTURA	
9861	12	Ng Dcha	818 mm	1
9862	12	Ng Izqda	818 mm	1
9806	13	Ng Dcha	878 mm	1
9807	13	Ng Izqda	878 mm	1

A partir de 24 lamas los mecanismos llevan dos palancas incluidas

## NEGRO



P-36				
CODIGO	LAMAS	MANO	ALTURA	
6818	6	Dcha	458 mm	<b>DOBLE PALANCA</b>
6819		Izqda		
6820	7	Dcha	518 mm	
6821		Izqda		
6822	8	Dcha	578 mm	
6823		Izqda		
6824	9	Dcha	638 mm	
6825		Izqda		
6826	10	Dcha	698 mm	
6827		Izqda		
6828	11	Dcha	758 mm	
6829		Izqda		
6830	12	Dcha	818 mm	
6831		Izqda		
6832	13	Dcha	878 mm	
6833		Izqda		
6834	14	Dcha	938 mm	
6835		Izqda		
6836	15	Dcha	998 mm	
6837		Izqda		
6838	16	Dcha	1058 mm	
6839		Izqda		
6840	17	Dcha	1118 mm	
6841		Izqda		
6842	18	Dcha	1178 mm	
6843		Izqda		
6844	19	Dcha	1238 mm	
6845		Izqda		
6846	20	Dcha	1298 mm	
6847		Izqda		
6848	21	Dcha	1358mm	
6849		Izqda		
6850	22	Dcha	1418 mm	
6851		Izqda		
6852	23	Dcha	1478 mm	
6853		Izqda		
6854	24	Dcha	1538 mm	
6855		Izqda		
6856	25	Dcha	1598 mm	
6857		Izqda		
6858	26	Dcha	1658 mm	
6859		Izqda		
6860	27	Dcha	1718 mm	
6861		Izqda		
6862	28	Dcha	1778 mm	
6863		Izqda		
6864	29	Dcha	1838mm	
6865		Izqda		

## BLANCO



P-36				
CODIGO	LAMAS	MANO	ALTURA	
6949	6	Dcha	458 mm	<b>DOBLE PALANCA</b>
6950		Izqda		
6951	7	Dcha	518 mm	
6952		Izqda		
6953	8	Dcha	578 mm	
6954		Izqda		
6955	9	Dcha	638 mm	
6956		Izqda		
6957	10	Dcha	698 mm	
6958		Izqda		
6959	11	Dcha	758 mm	
6960		Izqda		
6961	12	Dcha	818 mm	
6962		Izqda		
6898	13	Dcha	878 mm	
6899		Izqda		
6900	14	Dcha	938 mm	
6901		Izqda		
6967	15	Dcha	998 mm	
6968		Izqda		
6969	16	Dcha	1058 mm	
6970		Izqda		
6971	17	Dcha	1118 mm	
6972		Izqda		
6973	18	Dcha	1178 mm	
6974		Izqda		
6975	19	Dcha	1238 mm	
6976		Izqda		
6977	20	Dcha	1298 mm	
6978		Izqda		
6979	21	Dcha	1358mm	
6980		Izqda		
6981	22	Dcha	1418 mm	
6982		Izqda		
6983	23	Dcha	1478 mm	
6984		Izqda		
6985	24	Dcha	1538 mm	
6986		Izqda		
6987	25	Dcha	1598 mm	
6988		Izqda		
6989	26	Dcha	1658 mm	
6990		Izqda		
6991	27	Dcha	1718 mm	
6992		Izqda		
6993	28	Dcha	1778 mm	
6994		Izqda		
6995	29	Dcha	1838mm	
6996		Izqda		

Mecanismo P-70 lama móvil con palanca.

## Montante P-25

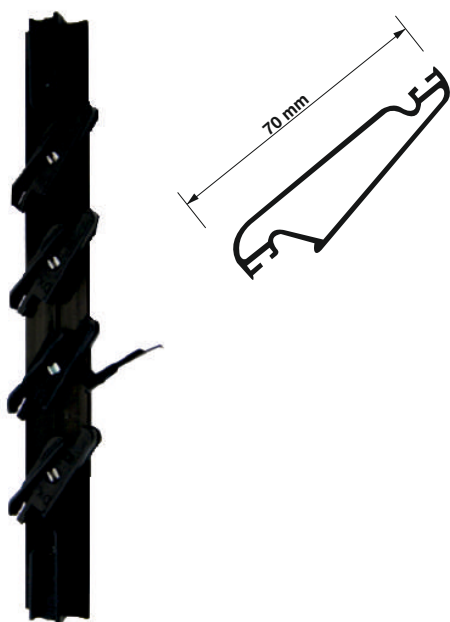

### Jgo Terminal Cortizo

CODIGO	
18646	1



A partir de 24 lamas los mecanismos llevan dos palancas incluidas

### NEGRO



P-25	CODIGO	LAMAS	MANO	ALTURA
6	18660	6	Dcha	458 mm
	19186		Izqda	
7	19187	7	Dcha	518 mm
	19188		Izqda	
8	16241	8	Dcha	578 mm
	18330		Izqda	
9	18659	9	Dcha	638 mm
	18658		Izqda	
10	18331	10	Dcha	698 mm
	18332		Izqda	
11	14819	11	Dcha	758 mm
	18657		Izqda	
12	14212	12	Dcha	818 mm
	14213		Izqda	
13	14609	13	Dcha	878 mm
	14818		Izqda	
14	16872	14	Dcha	938 mm
	16873		Izqda	
15	16796	15	Dcha	998 mm
	16797		Izqda	
16	14142	16	Dcha	1058 mm
	14143		Izqda	
17	14144	17	Dcha	1118 mm
	14145		Izqda	
18	13488	18	Dcha	1178 mm
	13489		Izqda	
19	16875	19	Dcha	1238 mm
	16874		Izqda	
20	16794	20	Dcha	1298 mm
	16795		Izqda	
21	16876	21	Dcha	1358 mm
	16877		Izqda	
22	14816	22	Dcha	1418 mm
	14817		Izqda	
23	14208	23	Dcha	1478 mm
	14209		Izqda	
24	17101	24	Dcha	1538 mm
	18666		Izqda	
25	23314	25	Dcha	1598 mm
	23315		Izqda	
26	21668	26	Dcha	1658 mm
	21669		Izqda	
27	18726	27	Dcha	1718 mm
	18725		Izqda	
28	-----	28	Dcha	1778 mm
	-----		Izqda	
29	-----	29	Dcha	1838 mm
	-----		Izqda	

DOBLE PALANCA

### BLANCO



P-25	CODIGO	LAMAS	MANO	ALTURA
6	-----	6	Dcha	458 mm
	-----		Izqda	
7	-----	7	Dcha	518 mm
	-----		Izqda	
8	-----	8	Dcha	578 mm
	-----		Izqda	
9	24114	9	Dcha	638 mm
	24115		Izqda	
10	18006	10	Dcha	698 mm
	18007		Izqda	
11	21064	11	Dcha	758 mm
	-----		Izqda	
12	24116	12	Dcha	818 mm
	24117		Izqda	
13	23860	13	Dcha	878 mm
	23861		Izqda	
14	18005	14	Dcha	938 mm
	24113		Izqda	
15	18014	15	Dcha	998 mm
	18015		Izqda	
16	18012	16	Dcha	1058 mm
	18013		Izqda	
17	18011	17	Dcha	1118 mm
	18010		Izqda	
18	18008	18	Dcha	1178 mm
	18009		Izqda	
19	24111	19	Dcha	1238 mm
	24112		Izqda	
20	-----	20	Dcha	1298 mm
	-----		Izqda	
21	-----	21	Dcha	1358 mm
	-----		Izqda	
22	-----	22	Dcha	1418 mm
	-----		Izqda	
23	-----	23	Dcha	1478 mm
	-----		Izqda	
24	-----	24	Dcha	1538 mm
	-----		Izqda	
25	6987	25	Dcha	1598 mm
	6988		Izqda	
26	-----	26	Dcha	1658 mm
	-----		Izqda	
27	-----	27	Dcha	1718 mm
	-----		Izqda	
28	-----	28	Dcha	1778 mm
	-----		Izqda	
29	21065	29	Dcha	1838 mm
	21066		Izqda	

DOBLE PALANCA



## Grillo WONDER BLOCK.

CODIGO	REF.	COLOR	
23592	WONDER BLOCK	Blanco	25
23591	WONDER BLOCK	Negro	25



## Fijador de ventana a pared.

CODIGO	REF.	COLOR	
2290	SPP	Blanco	150
2291	SPP	Negro	150



## Iman retenedor

CODIGO	REF.	COLOR	
6084		Negro	2



7

## “Grillo” fijador de puerta a pared.

CODIGO	REF.	COLOR	MEDIDA	
2288	221B	Blanco	max. 52mm	50
2289	221B	Negro		
2286	224B	Blanco	max. 94mm	20
2287	224B	Negro		
2284	225B	Blanco	max. 115mm	20
2285	225B	Negro		



## “Grillo” fijador de puerta a pared (con muelle retenedor)

CODIGO	REF.	COLOR	
18292	9000B	Blanco	60
18293	9000P	Negro	
18294	9000/2B	Blanco	40
18295	9000/2P	Negro	
18296	297	Blanco	150
18297	297	Negro	

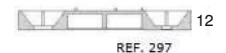
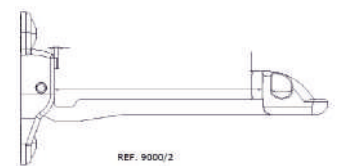
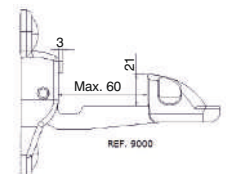

## Compás retenedor grillo inox 1ª y 2ª hoja. Para 40x20 o CE.

CODIGO	REF.	MANO	
4448	NI 5100 40x20	Derecha	50
4497	NI 5100 40x20	Izquierda	
3313	NI 5000 CE	Derecha	
4450	NI 5000 CE	Izquierda	

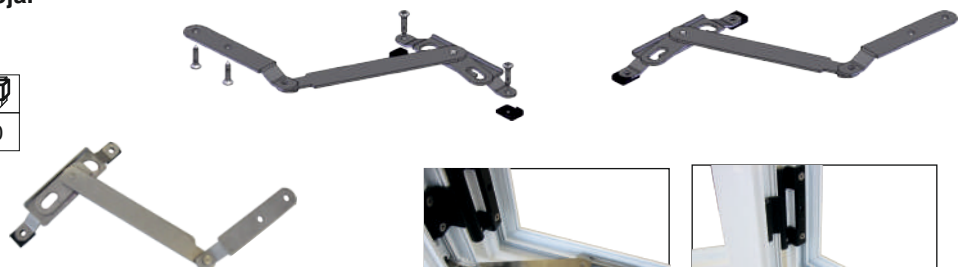

**NOTA:** Los tornillos no van incluidos.

## Separador M-23 reversible

CODIGO	REF.	COLOR	
3363	S M-23	Blanco	1500
3364	S M-23	Negro	1500

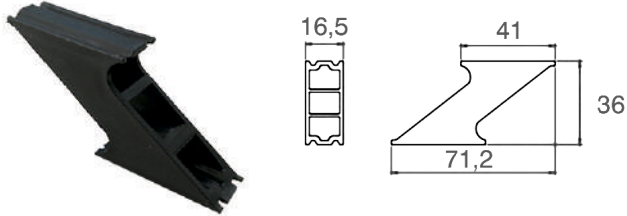

## Terminal M-23.

CODIGO	REF.	COLOR	
3581	T M-23	Blanco	400
3582	T M-23	Negro	400



## Soporte lama ovalina M-44

CODIGO	REF.	COLOR	
3498	M-44	Blanco Dcha	100
3500	M-44	Blanco Izq	
5297	M-44	Negro Dcha	
5298	M-44	Negro Izq	

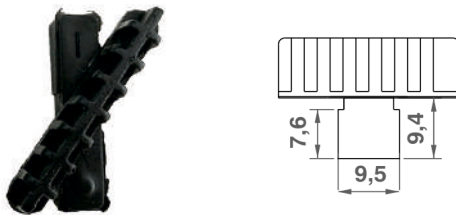

## Soporte lama ovalina M-7 1055

CODIGO	MEDIDA	COLOR	
3506	M-7 1055	Blanco Dcha	200
3510	M-7 1055	Blanco Izq	
3507	M-7 1055	Negro Dcha	
3511	M-7 1055	Negro Izq	

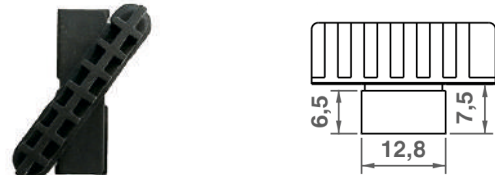

## Soporte lama fija corredera (inclinación 20°)

CODIGO	REF.	COLOR	
4030	-----	Negro Dcha	500
4031	-----	Negro Izq	

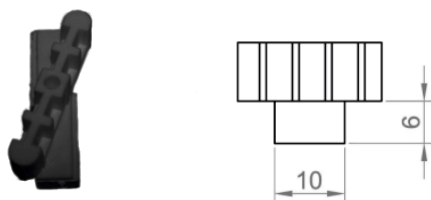

## Soporte lama ovalina M-7 1135 (lama Andaluica)

CODIGO	MEDIDA	COLOR	
3508	M-7 1135	Blanco Dcha	200
3512	M-7 1135	Blanco Izq	
3509	M-7 1135	Negro Dcha	
3513	M-7 1135	Negro Izq	



## Cerradura Serie A.

Picaporte y palanca deslizando (incluye cerradero)

CÓDIGO	REF.	A	
1732	A	25	30
1733	A	30	30
1734	A	35	30
16831	A	70	30

- Frontal Inox



A	25	30	35
B	38	43	48

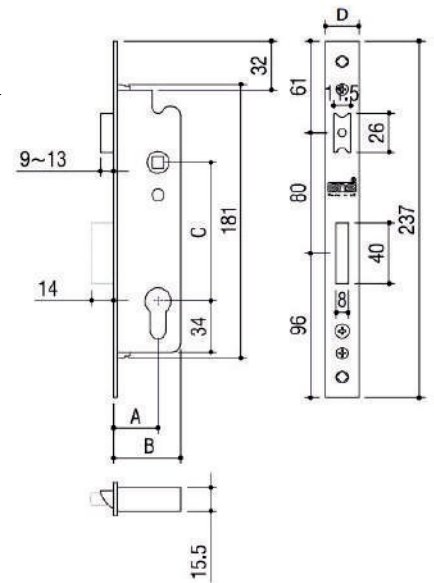

## Cerradura

(hay que utilizar cilindros de leva corta)

CÓDIGO	REF.	A	Palanca	
1731	A	23	deslizante	30
22365	742F	33	deslizante	12

## Cilindro leva corta

CÓDIGO	REF.	
6722	3030	1
7123	3040	1

## Cerradura Serie C

Picaporte y palanca basculante (incluye cerradero regulable)

CÓDIGO	REF.	A	
1739	C	25	30
1740	C	30	30
1741	C	35	30

- Frontal Inox



A	25	30	35
B	37	42	47

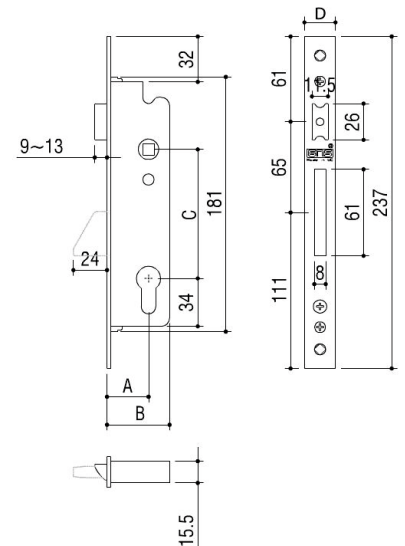

## Rodillo intercambiable.

(incluye el suplemento para cerradero)

CÓDIGO	REF.	
15783	3800	1



## Cerradura Serie E

Picaporte y gancho basculante

CÓDIGO	REF.	A	
1745	E	25	30
1746	E	30	30
1747	E	35	30

- Frontal Inox

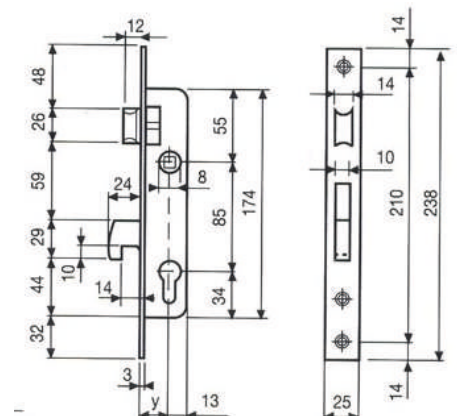

**NOTA:** Estas cerraduras no incluyen el cilindro.

## Cerradura Serie B

Rodillo y palanca deslizante (incluye cerradero)

CÓDIGO	REF.	A	
1736	B	25	30
1737	B	30	30
1738	B	35	30

- Frontal Inox



A	25	30	35
B	38	43	48

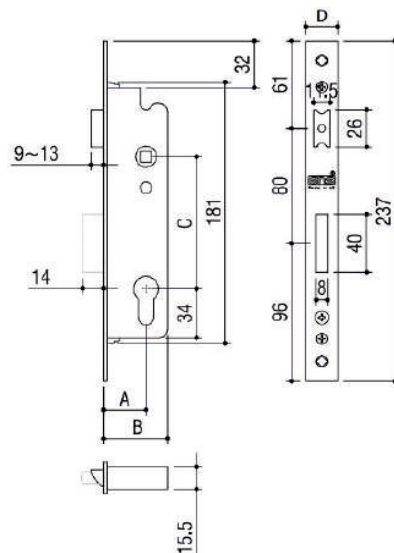

8

## Cerradura Serie I

Gancho basculante

CÓDIGO	REF.	A	
1758	I	25	30
1759	I	30	30
1760	I	35	30

- Frontal Inox



A	25	30	35
B	37	42	47

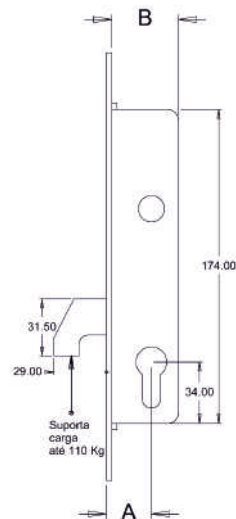

## Cerradura 7716 ST

Sólo picaporte

CÓDIGO	REF.	A	
7360	9794	25	30
2071	7716ST	30	30
2074	7716ST	35	30

- Frontal In



A	25	30	35
B	37	42	47

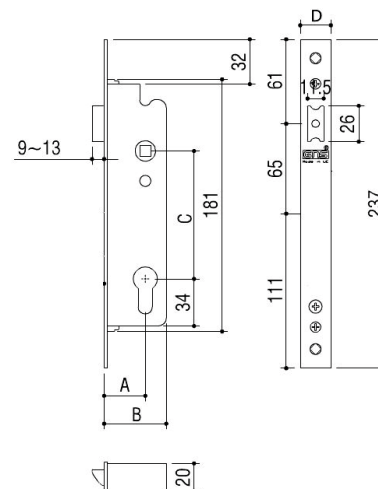

**NOTA:** La referencia 9794 es solo con acción manilla. Medida total de alto 99mm.

**NOTA:** Estas cerraduras no incluyen el cilindro.

## Cerradura Zócalo 5791

Sólo picaporte



10

CÓDIGO	REF.	A
1832	5791	70mm
17113	5791	90mm

- Frontal Inox

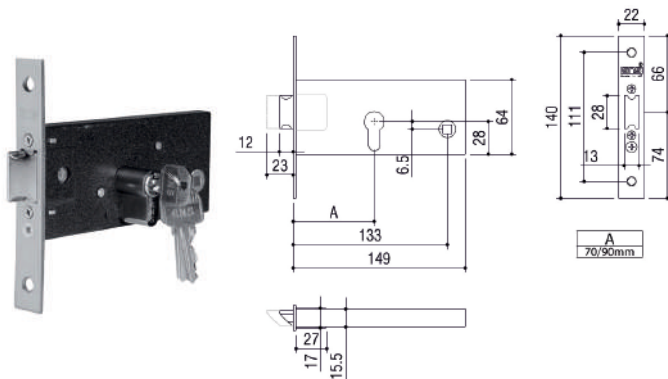

## Cerradura Zócalo 5790

Con cilindro 27x27 ovalado

CÓDIGO	REF.	A
11898	5790	80mm

## Cerradura 9796

Pico loro.

CÓDIGO	REF.	A	Icon
1761	9796	30mm	30

- Frontal Inox

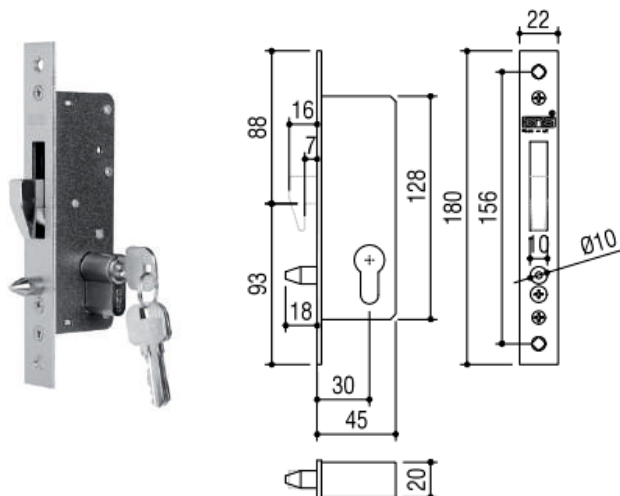

## Cerradura 9791

Solo deslizante.



20

CÓDIGO	REF.	A
5892	9791	20
7569	9791	25
8270	9791	30

- Frontal Inox

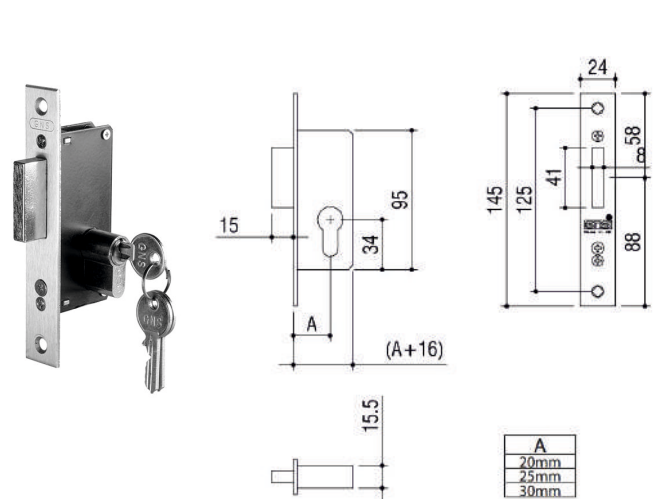

## Cerradura 9793

Sólo rodillo

CÓDIGO	REF.	A	Icon
14423	9793	20	1

- Frontal Inox

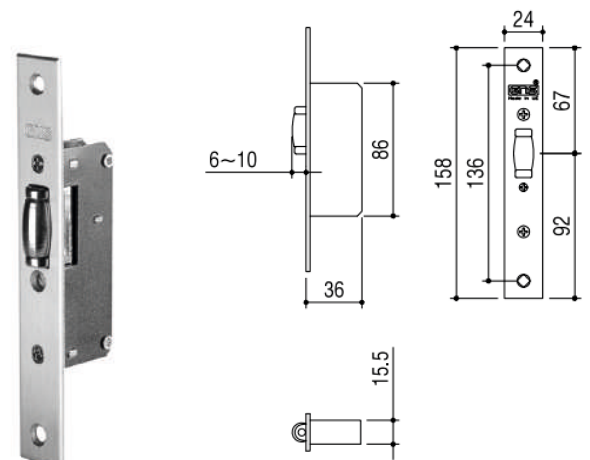

**NOTA:** Estas cerraduras no incluyen el cilindro.

Picaporte y palanca deslizante (no incluye el cerradero)



CÓDIGO	REF.	A	
15023	44661.25	25	24
15024	44661.30	30	24
14976	44661.35	35	24

- Frontal zincado

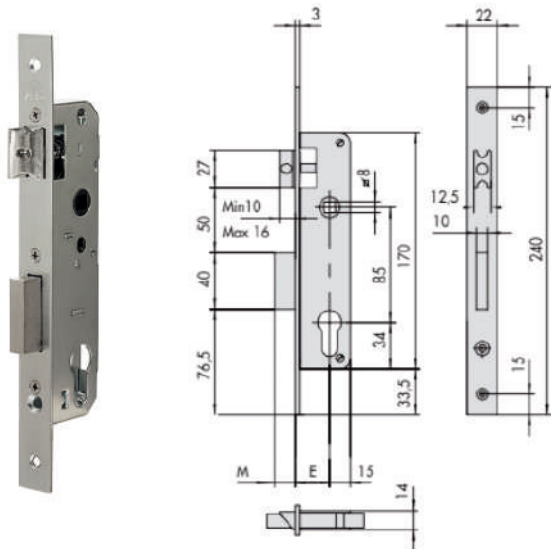

## Cerradura Serie B CISA (frontal cincado)



CÓDIGO	REF.	A	
15451	44671.35	35	1

Cerradero para cerradura 44870

11731	0604.05
-------	---------

- Frontal zincado

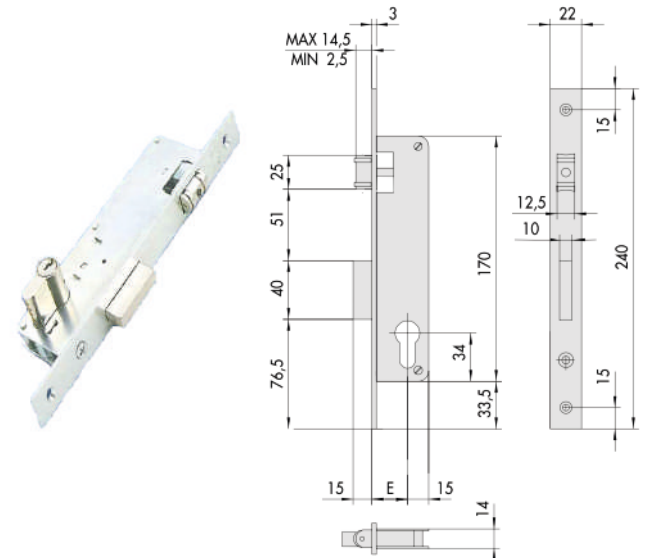

**NOTA:** Estas cerraduras no incluyen el cilindro.

8

## Cerradura 46215

Picaporte y palanca basculante (sin cerradero)



CÓDIGO	REF.	A	
846	46215	30	1
13838	46215	35	1

- Frontal zincado

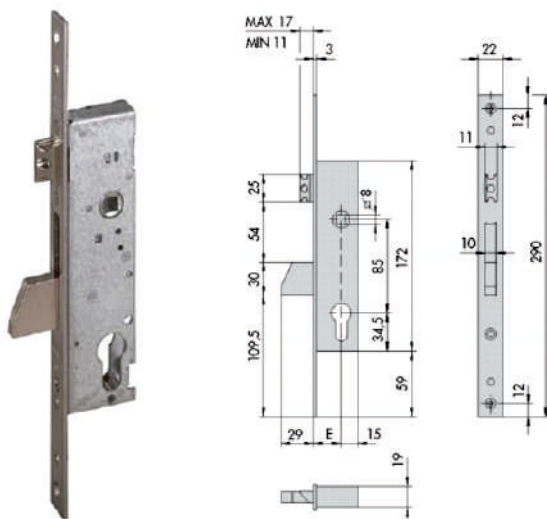

## Cerradura con cilindro ovalado

Picaporte y palanca. (incluye cilindro 28x28)



CÓDIGO	REF.	A	
829	44221	15	1



**NOTA:**

Es necesario utilizar manilla interior para accionar el picaporte.

## Cerradura zocalo con cilindro ovalado

Picaporte (incluye cilindro 28x28)

CÓDIGO	REF.	A	
827	44151.70.0	44	1

**NOTA:** Estas cerraduras no incluyen el cilindro.





## Cerradura 3 puntos palancas basculantes

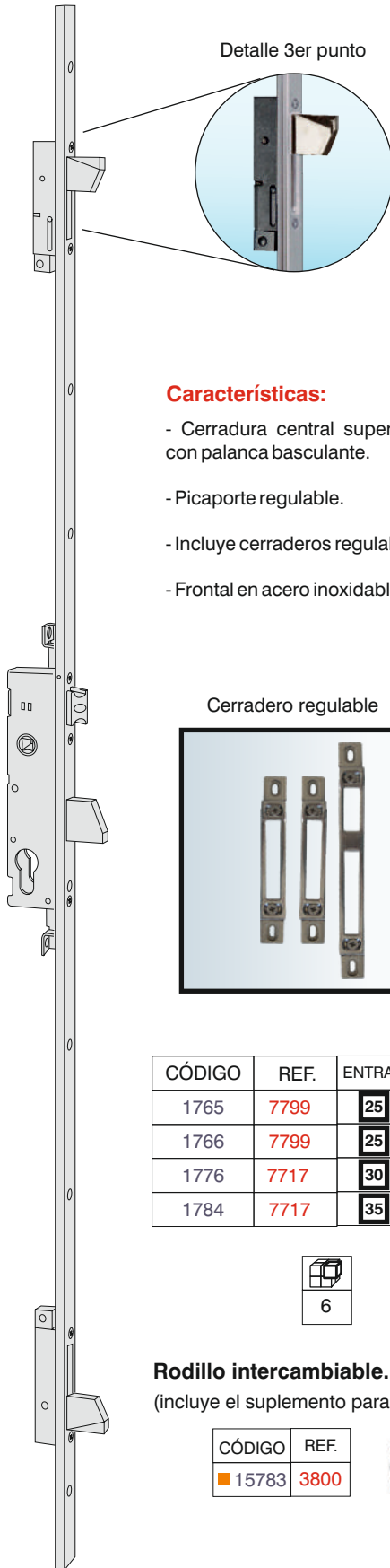

Detalle 3er punto

### Características:

- Cerradura central superior e inferior con palanca basculante.
- Picaporte regulable.
- Incluye cerraderos regulables.
- Frontal en acero inoxidable.

Cerradero regulable



CÓDIGO	REF.	ENTRADA	FRENTE
1765	7799	25	—
1766	7799	25	┌
1776	7717	30	┌
1784	7717	35	┌



### Rodillo intercambiable.

(incluye el suplemento para cerradero)

CÓDIGO	REF.
15783	3800



## Cerradura de seguridad de 3 puntos.

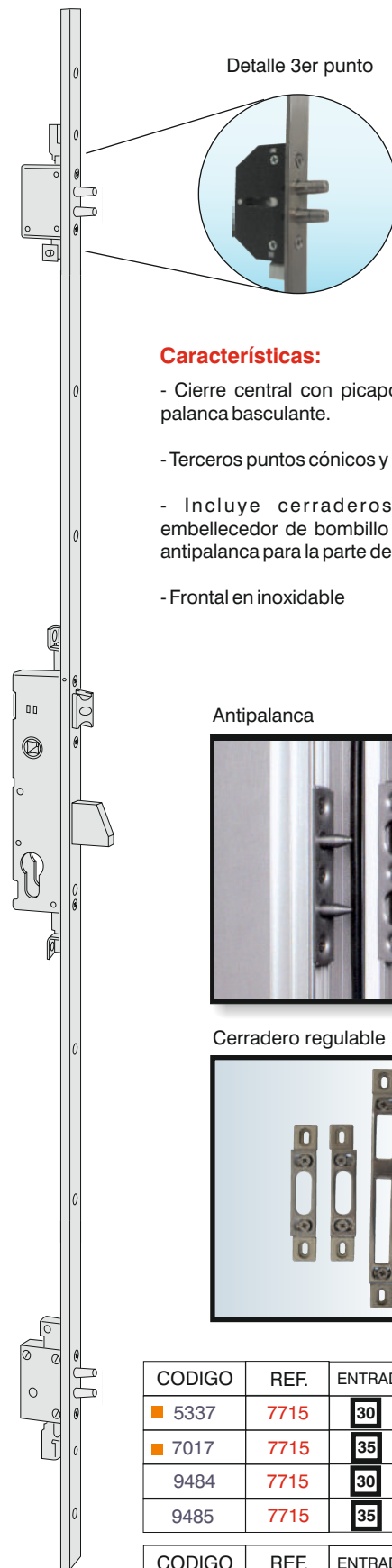

Detalle 3er punto

### Características:

- Cierre central con picaporte regulable y palanca basculante.
- Terceros puntos cónicos y deslizantes
- Incluye cerraderos regulables, embellecedor de bombillo de seguridad y antipalanca para la parte de las bisagras.
- Frontal en inoxidable

Antipalanca



Cerradero regulable



CODIGO	REF.	ENTRADA	FRENTE
5337	7715	30	— Inox
7017	7715	35	— Inox
9484	7715	30	— Duraluminio
9485	7715	35	— Duraluminio

CODIGO	REF.	ENTRADA	FRENTE
20930	7715	30	U Inox

### Cierre antipalanca

CÓDIGO	REF.	ENTRADA	FRENTE
5390	3600	6	



## Cerradura 3 puntos engranaje



- Placa frontal en acero inoxidable 304, en forma plana y en U
- RESBALÓN / PICAPORTE  
Fácil intercambio de mano a derecha o izquierda. Tratamiento superficial de zinc / níquel, con protección anticorrosiva hasta 480h cámara salina. Con silenciador autolubricante. Probado según norma EN 12209.
- PALANCA DESLIZANTE  
Con bloqueo progresivo debido al sistema de engranajes, también con protección superficial anticorrosiva de 480h.
- PUNTOS DE CIERRE SEGURIDAD  
Pasadores de seguridad cónicos de acero inoxidable en los cierres superior e inferior.
- Funciona tanto con cilindros de leva corta como de leva larga
- Incluye cerraderos regulables

CODIGO	REF.	ENTRADA	FRENTE	
23901	7615	30	—	1
23902	7615	35	—	1
24136	7615	35	U	1

## Cerradura 3 puntos Engranaje

**MULTITOP PRO**

CODIGO	REF.	Entrada	Frente
10160	4942630	30	
490	cerradero central de seguridad (40x40)		
492	cerradero central super. e infer. (40x40)		

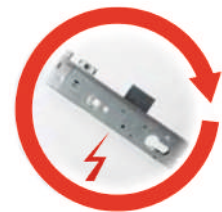

### Características:

- 10 engranajes que aseguran un funcionamiento suave y un perfecto alineamiento de la puerta.



- Frontal acero barnizado
- Picaporte y palancas niqueladas
- Cajas con protección de zinc
- Picaporte regulable

CODIGO	REF.	Entrada	Frente	
■ 10161	4952630	30	—	1
■ 10265	4952635	35	—	1
15335	4952640	40	—	1
■ 812	cerrad. central seguridad CE			10
■ 814	cerradero super. e infer. CE			10
■ 13028	rodillo para multitop			12

Disponemos de otros desplazamientos sobre pedido

**NOTA:** La cerradura Multitop debe utilizarse **siempre** con cilindros de leva larga

**NOTA:** La cerradura Multitop esta disponible en automática y posibilidad de añadir motor.

## Cerradura de seguridad SECURY AUTOMATIC (distancia de 92mm)



### Características:

- Con el pestillo de la cerradura se obtiene un cierre en 3 puntos de la puerta.

- Simplemente con cerrar la puerta, 2 resbalones se transforman automáticamente en paletones fijos bloqueando la puerta totalmente. (Salida de los resbalones automáticos 20mm).

CODIGO	REF.	ENTRADA	FRENTE	
5780	6290393101	35	—	1
9757	Motor			1

**NOTA:** Obligatoriamente se debe utilizar un tirador en lugar de una manilla para el lado exterior.

## Cerradura automática Av3 M2 gancho (desplazamiento 92mm)

### Cerradura automática

CODIGO	REF.	ENTRADA	FRENTE	MANO	
24739	5006133-R	35	—	Dcha	1
24740	5006132-L	35	—	Izqda	1
24741	5007849-R	45	—	Dcha	1
24742	5007847-L	45	—	Izda	1

### Cerradero central

CODIGO	REF.	MANO	
24743	5013112	Dcha	1
24744	5013114	Izqda	1

### Cerradero superior/inferior largo jgo

CODIGO	REF.	
18959	5013112	1

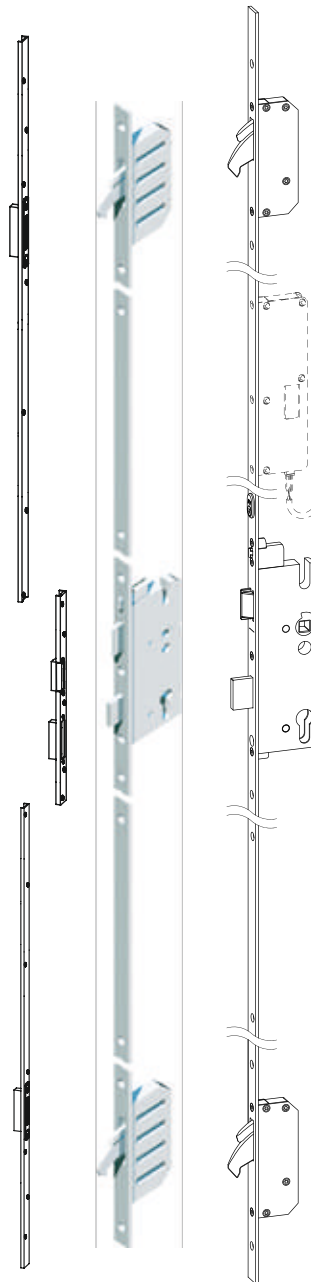
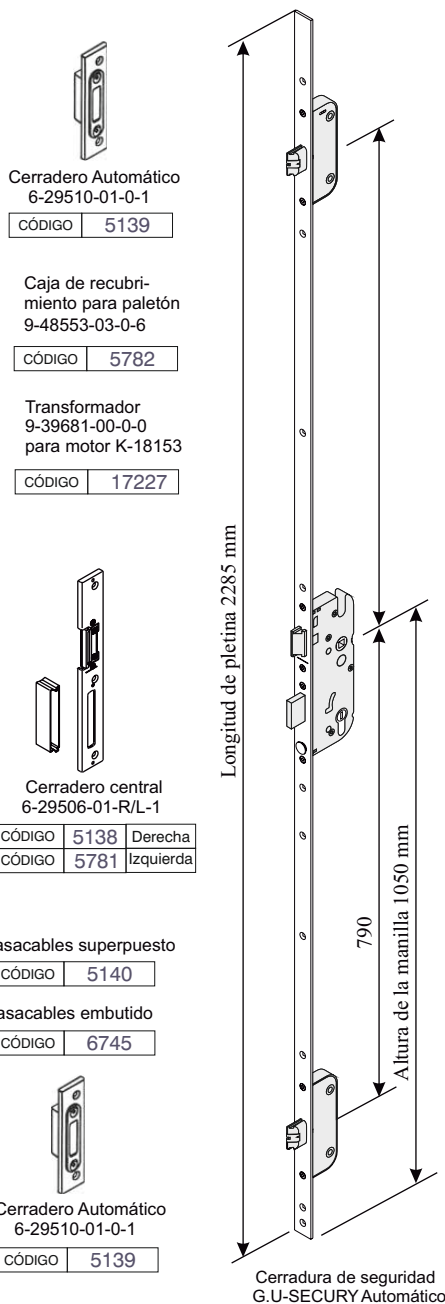

### Motor

CODIGO	REF.	
20875	5009320	1

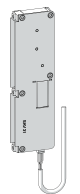

### Iman

CODIGO	REF.	
24745	5009111	1

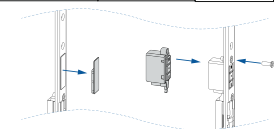

### Transformador

CODIGO	REF.	
21895	TF4.1	1

### Cable hoja 3.5m

CODIGO	REF.	
24073	5040505	1



### Cable marco 4m

CODIGO	REF.	
24074	5040503	1

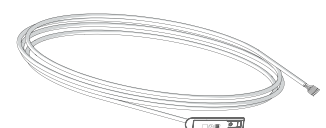

## Cilindro normal 3 llaves



Para otras medidas y modelos consultar con Dpto.Comercial



### CILINDRO NORMAL

BOMBILLO	MEDIDAS			
CÓDIGO	A	B	L	
■ 817	30	30	60	16
■ 6324	28	34	62	16
■ 5433	30	40	70	16
■ 7707	30	50	80	16
■ 5827	40	40	80	16
■ 7468	30	60	90	16
■ 6611	40	50	90	16
■ 5860	30	70	100	16
■ 11902	40	60	100	16
■ 10699	50	50	100	16



### CILINDRO NORMAL LEVA CORTA

BOMBILLO LEVA CORTA	MEDIDAS			
CÓDIGO	A	B	L	
6722	30	30	60	1
7123	30	40	70	1
■ 6444	30	50	80	1
■ 7173	30	60	90	1
■ 17376	30	70	100	1

### MEDIO CILINDRO NORMAL

MEDIO BOMBILLO	MEDIDAS			
CÓDIGO	A	B	L	
■ 3237	30	10	40	1
■ 6014	40	10	50	1
■ 17027	50	10	60	1
■ 7746	60	10	70	1
■ 11212	70	10	80	1

### CILINDRO NORMAL ALINEADO



BOMBILLO ALINEADO	MEDIDAS			
CÓDIGO	A	B	L	
■ 7033 (Ref. 3-6-6-5-6)	30	30	60	1
■ 7034 (Ref. 3-6-6-5-6)	30	40	70	1
■ 7035 (Ref. 1-3-2-3-6)	30	30	60	1
■ 7036 (Ref. 1-3-2-3-6)	30	40	70	1
■ 7564 (Ref. 1-3-2-3-6)	30	50	80	1
■ 7246 (Ref. 1-3-2-3-6)	40	40	80	1
■ 7330 (Ref. 1-3-2-3-6)	30	60	90	1
■ 10589 (Ref. 1-3-2-3-6)	40	50	90	1
■ 6402 (Ref. 1-3-2-3-6)	30	70	100	1



## Cilindro normal con pomo



BOMBILLO	MEDIDAS		
CÓDIGO	A (pomo)	B	L
■ 6762	30	30	60
■ 5666	30	40	70
■ 6761	40	30	70
18290	50	30	80
8176	40	40	80
■ 18739	30	60	90

MEDIO BOMBILLO	MEDIDAS		
CÓDIGO	A (pomo)	B	L
■ 13830	30	10	43
■ 13831	40	10	53



Para cilindros con leva corta, consultar al Dpto.Comercial

## Cilindro normal 3 llaves



BOMBILLO	MEDIDAS		
CÓDIGO	A	B	L
2107	30	30	60
2108	30	40	70
3243	30	50	80
11970	30	60	90





## Cilindro seguridad 5 llaves



### CILINDRO SEGURIDAD

BOMBILLO		MEDIDAS			
CÓDIGO	A	B	L		
■ 865	30	30	60	1	
■ 3350	28	34	62	1	
■ 866	30	40	70	1	
■ 14630	30	45	75	1	
■ 14724	35	45	80	1	
■ 6636	30	50	80	1	
■ 5732	40	40	80	1	
■ 8585	30	60	90	1	
■ 8978	40	50	100	1	
■ 7310	30	70	100	1	
■ 13576	40	60	100	1	
■ 7843	50	50	100	1	

Para cilindros con leva corta, consultar al Dpto.Comercial

## CILINDRO SEGURIDAD ALINEADO



BOMBILLO ALINEADO		MEDIDAS			
CÓDIGO	A	B	L		
■ 7038 (Ref. Z16567AM)	30	30	60	1	
■ 7040 (Ref. Z16567AM)	30	40	70	1	

BOMBILLO ALINEADO		MEDIDAS			
CÓDIGO	A	B	L		
■ 7037 (Ref. Z07168AM)	30	30	60	1	
■ 7039 (Ref. Z07168AM)	30	40	70	1	
■ 7438 (Ref. Z07168AM)	30	50	80	1	
■ 16806 (Ref. Z07168AM)	30	60	90	1	
■ 7848 (Ref. Z07168AM)	50	40	90	1	
■ 4389 (Ref. Z07168AM)	50	50	100	1	
■ 10847 (Ref. Z07168AM)	30	70	100	1	
■ 17606 (Ref. Z07168AM)	50	60	110	1	

8

## Cilindro Seguridad con pomo



BOMBILLO		MEDIDAS		
CÓDIGO	A (pomo)	B	L	
14636	30	40	70	
23566	30	50	80	
23567	30	60	90	

## Cilindro Seguridad



BOMBILLO		MEDIDAS		
CÓDIGO	A	B	L	
1804	30	30	60	
1805	30	40	70	
1806	30	50	80	
13146	30	60	90	



## Cilindro doble embrague seguridad ASIX P8



BOMBILLO		MEDIDAS			
CÓDIGO	A	B	L		
24538	30	30	60	16	
24539	30	40	70	16	
24540	30	50	80	16	
24541	40	40	80	16	
24516	30	60	90	16	

BOMBILLO		MEDIDAS			
CÓDIGO	A	B	L		
24542	30	70	100	16	
24612	40	60	100	16	
24543	50	50	100	16	
24679	30	80	110	16	
24613	50	60	110	16	

## SEGURIDAD

Protección certificada contra el "bumping", gracias a la tecnología patentada BKP (Bump Key Power), PATENTE BKP PCT/WO 2007/074163A1.

Protección certificada contra el taladro, gracias al sistema de cifratura de acero carbonitrurado.

Elevada resistencia a la técnica de efracción con impresión a cera, gracias a la especial configuración de los muelles. La Tarjeta de propiedad garantiza un duplicado de la llave protegido y de calidad; en efecto, a partir del código de identificación de la llave, es posible hacer una copia fiel de la misma, incluso sin la llave original o con la llave dañada.



## Muletilla

CODIGO	REF.	COLOR
■ 4326	FCM - larga	Blanco
■ 4325	FCM - larga	Negro
398	FCM - larga	Plata
4933	FCM - larga	Inox



## Dispositivo de condena

CODIGO	REF.	L
1810	FCDCC	Corto
■ 1809	FCDCL	Largo



## Llaves

CODIGO	REF.	
■ 3347	Llave virgen normal cisa	1
■ 12550	Llave virgen seguridad cisa	1
■ 19621	Llave normal tallada	1
■ 19622	Llave seguridad tallada	1



## Embellecedor de bombillo

CODIGO	REF.	ACABADO	COLOR	
■ 1373	9010	Nylon	Blanco	150
■ 1374	9010	Nylon	Negro	150
■ 2150	3500	Metálico	Blanco	150
■ 2151	3500	Metálico	Negro	150
10128	3500	Metálico	Lac Plata	150
10248	3500	Metálico	Lac Inox	150

9010 - 3500



## Embellecedor de bombillo

CODIGO	REF.	ACABADO	COLOR	
1375	9020	Nylon	Blanco	150
1376	9020	Nylon	Negro	150

9020



## Embellecedor de bombillo

CODIGO	REF.	ACABADO	COLOR	
13581	M69	Metálico	Blanco	150
13582	M69	Metálico	Negro	150

M69 - SEGURIDAD



## Cerradero CE regulable inox central.

CODIGO	REF.	
2081	CT1	100

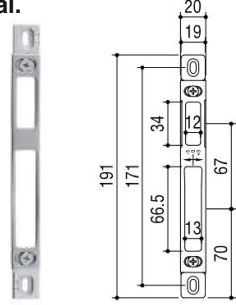

## Cerradero CE regulable negro CISA central

CODIGO	REF.	
811	66463.72	10



## Cerradero CE regulable inox superior e inferior.

CODIGO	REF.	
2082	CT2	150

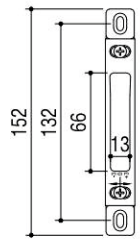

## Cerradero de aluminio regulable normal central CE.

CODIGO	REF.	COLOR	
495	3017	Blanco	150
494	3017	Negro	150

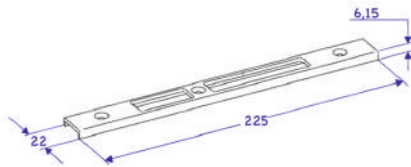

## Cerradero de aluminio regulable normal superior/inferior CE.

CODIGO	REF.	COLOR	
497	3018	Blanco	200
496	3018	Negro	200

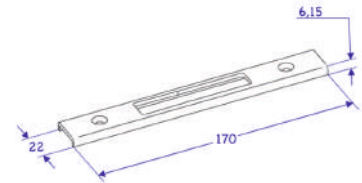

8

## Cerradero de eléctrico largo.(multivoltaje) Frente inox. CE

CODIGO	REF.	
21796	99-2-ABF-LX22	20

## Cerradero de eléctrico largo.(multivoltaje) Frente inox. CE CON PALANCA

CODIGO	REF.	
14519	99-2-ABDF-LX22	20

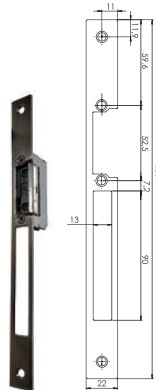
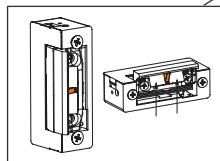

## Cerradero de eléctrico corto. (multivoltaje) Frente inox.

CODIGO	REF.		
21798	99-2-ABF-SX22	CE	20

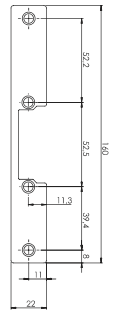
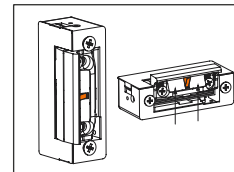

## Cerradero eléctrico sin fresado.

CODIGO	REF.		
21795	99 TOP	largo	1
21800	99 TOP	corto	

CAJA DE MECANISMOS

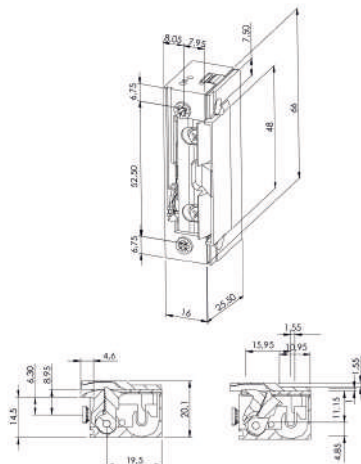

- Nuevo sistema con rampa de guiado del picaporte
- Tapa con sistema antigripado
- Multivoltaje
- AC/DC
- Reducidas dimensiones
- Pestillo radial
- Simétrico
- Reversible

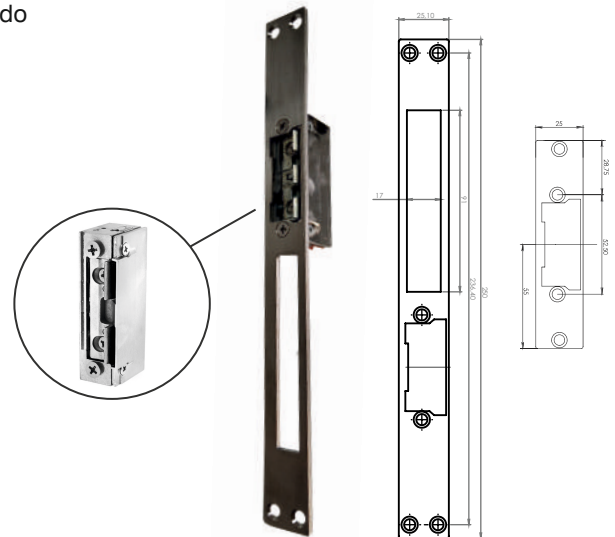

## Cerradero de aluminio regulable seguridad central 40x20.

CODIGO	REF.	COLOR	
491	3006	Blanco	200
490	3006	Negro	200

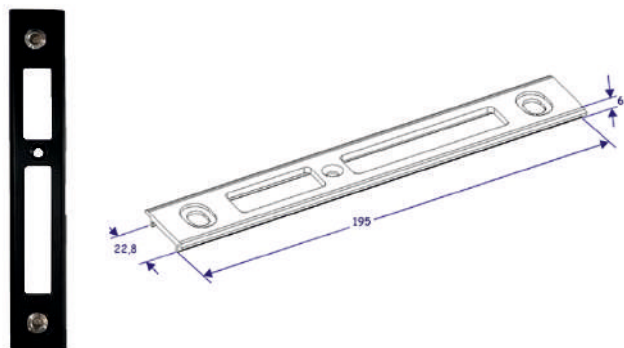

## Cerradero de aluminio regulable normal superior/inferior 40x20.

CODIGO	REF.	REF.	
493	3005	Blanco	200
492	3005	Negro	200

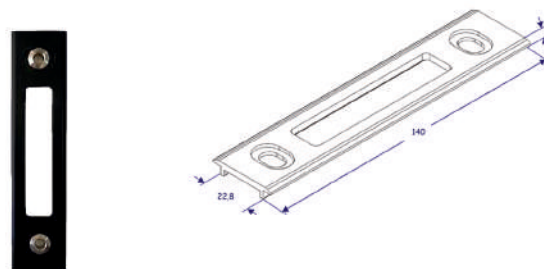

## Cerradero de eléctrico largo. (multivoltaje) Frente inox.

CODIGO	REF.		
21799	54-ABF-MX	4020	20

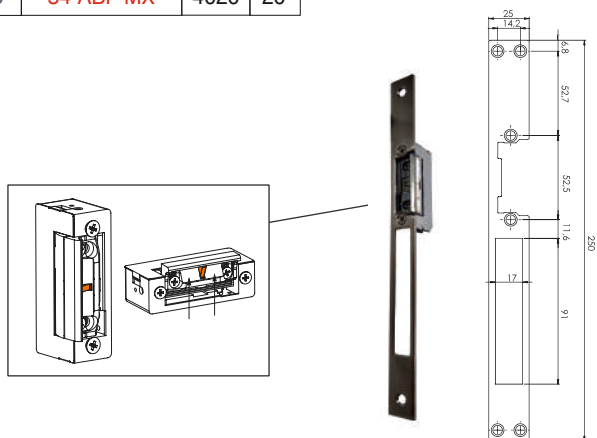

## Cerradero de eléctrico corto. (multivoltaje) Frente inox.

CODIGO	REF.		
21801	54-ABF-SX	4020	20

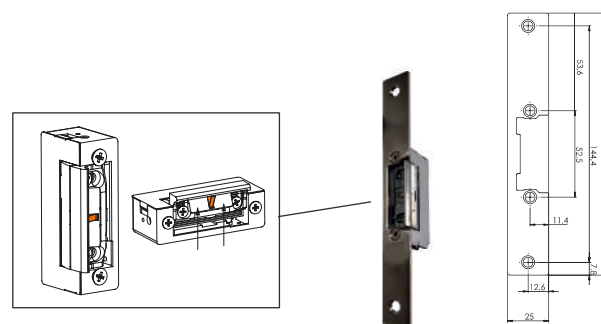

8

## Contactador (2 cables)

CÓDIGO	REF.	
815	06511.00.0	1



## Booster para cerraduras eléctricas

CÓDIGO	REF.	
14251	07022.00.0	150

## Contactador (3 cables)

CÓDIGO	REF.	
7366	30076/D	1



## Control de acceso K16 (teclado, tarjeta o bluetooth + transformador

CODIGO
24053

Versión con autenticación mediante teclado táctil / tarjeta con unacapacidad de hasta 1000 usuarios. Incorpora apertura mediante bluetooth a través de la APP.

Fácil instalación de sobreponer. También es ideal para exteriores gracias a su capacidad Ip66 y antivandálica Ik08.

Permite actuar sobre dos puertas, gracias a sus 2 relés que pueden configurar COM+ N/NQ.

### Tarjeta de proximidad K12 para control de acceso K16

CODIGO
24205

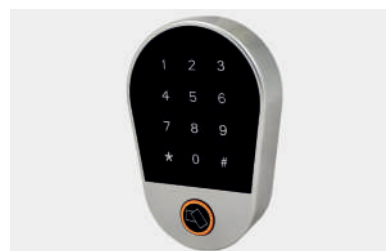

### CARACTERÍSTICAS ADICIONALES

Indicaciones	Led Retroiluminación Sonido
Alimentación	12 / 24 VDC
Consumo	Reposo ≤ 50mA Activo ≤ 120mA
Salida relé 1	1,5 A
Salida relé 2	1,5 A
Wiegand	Sí (26 ~ 58)

8

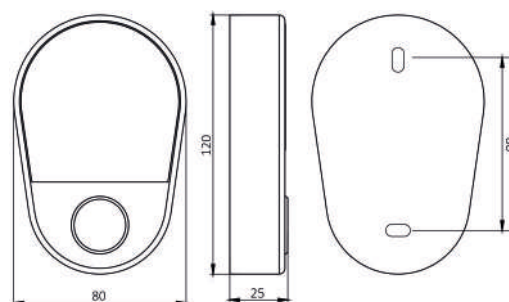

## Control de acceso emisor/receptor (incluye el transformador y dos mandos)

CÓDIGO	REF.
■ 15520	K4

### Mando a distancia extra

CÓDIGO	REF.
■ 17158	K43

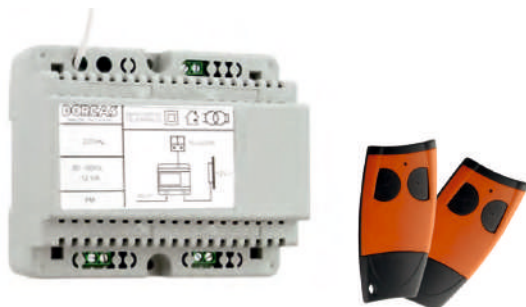

**NOTA:** Todos los controles de acceso deben utilizarse con cerradero eléctrico (ver pag.128-129)



### Tirador redondo 90° doble o simple

MEDIDA	CODIGO DOBLE	CODIGO SIMPLE	MEDIDA INTEREJE		<b>inox 316</b>
32x500	■ 19744	■ 19745	300	1	
32x800	-----	25330	600	1	
32x1400	-----	20187	1200	1	
32x1800	21883	20120	1300	1	
32x500	■ 14704	■ 13856	300	1	
32x1800	14759	14757	1300	1	

### Tirador redondo 45° doble o simple

MEDIDA	CODIGO DOBLE	CODIGO SIMPLE	MEDIDA INTEREJE		<b>inox 316</b>
32x500	■ 19743	■ 19657	300	1	
32x800	■ 20218	25329	600	1	
32x1400	-----	21149	1200	1	
32x1800	20121	19779	1300	1	
32x500	■ 12741	■ 11602	300	1	
32x1800	1473	1472	1300	1	

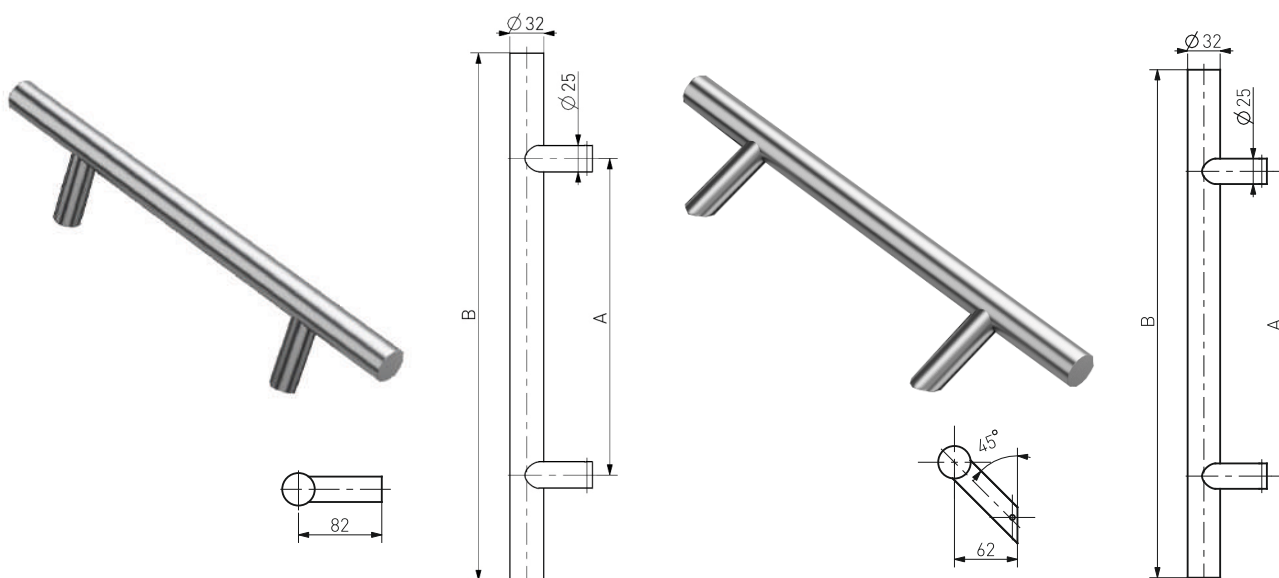

**NOTA:** Para los tiradores simples hay que añadir el kit para el tirador simple.

## Tirador rectangular 90° doble o simple

MEDIDA	CODIGO DOBLE	CODIGO SIMPLE	MEDIDA INTEREJE	
500	■ 19747	■ 19833	300	1
800	-----	25332	600	1
1400	-----	20012	1200	1
1800	20119	20117	1300	1

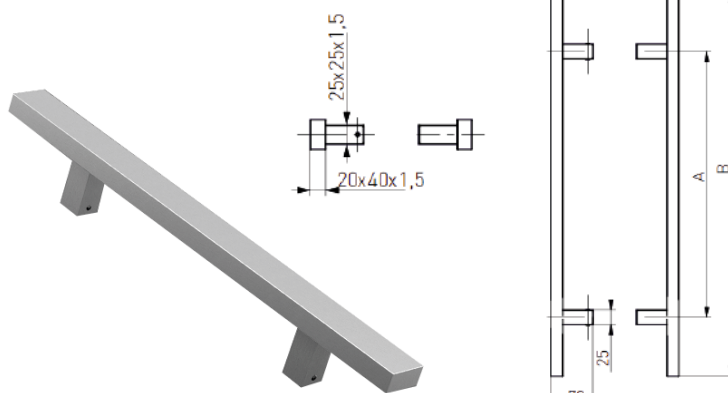

## Tirador rectangular 45° doble o simple

MEDIDA	CODIGO DOBLE	CODIGO SIMPLE	MEDIDA INTEREJE	
500	■ 19746	■ 19681	300	1
800	■ 21093	25331	600	1
1400	-----	20860	1200	1
1800	20118	19682	1300	1

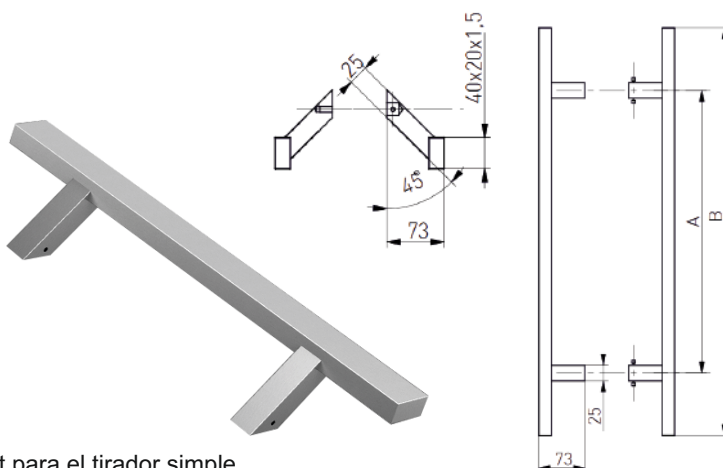

**NOTA:** Para los tiradores simples hay que añadir el kit para el tirador simple.

## Kit fijación para tirador simple

CODIGO	REF.		
■ 19659	104.0000.00.00	1	inox 316
14797	204.0000.00.00	1	

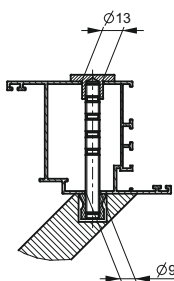

## Kit fijación para tirador simple

CODIGO	REF.	MEDIDA	
■ 19693	104.0000.35.00	35mm	1
■ 19683	104.0000.45.00	45mm	1
■ 19684	104.0000.55.00	55mm	1

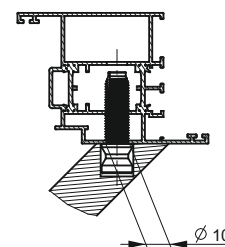

## Fijación para tiradores dobles

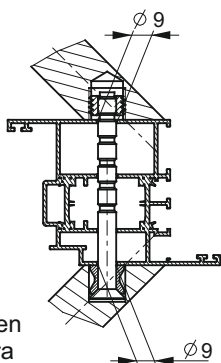

**NOTA:** Los tiradores dobles incluyen el tornillo de fijación y plásticos para el vidrio.

## Limpiador Inox

CODIGO	REF.
■ 22051	504.0030.00.00



Limpiador de acero inoxidable y otros metales no ferrosos. Elimina eficazmente la suciedad y el óxido. Biodegradable. Botella de 10ml





**Tirador redondo 90°**

CODIGO simple	MEDIDA	MEDIDA INTEREJE	
24771	32x500	300	1
25334	32x800	600	1
25231	32x1400	1200	1
24772	32x1800	1300	1



**Tirador rectangular 90°**

CODIGO simple	MEDIDA	MEDIDA INTEREJE	
24775	500	300	1
25336	800	600	1
25229	1400	1200	1
24778	1800	1300	1



**Tirador redondo 45°**

CODIGO Simple	MEDIDA	MEDIDA INTEREJE	
24773	32x500	300	1
25333	32x800	600	1
25230	32x1400	1200	1
24774	32x1800	1300	1



**Tirador rectangular 45°**

CODIGO Simple	MEDIDA	MEDIDA INTEREJE	
24776	500	300	1
25335	800	600	1
25228	1400	1200	1
24777	1800	1300	1

**NOTA:** Hay que incluir siempre el kit de fijación. Para hacer un tirador doble hay que pedir dos tiradores y el kit de fijación.

**NOTA:** Hay que incluir siempre el kit de fijación. Para hacer un tirador doble hay que pedir dos tiradores y el kit de fijación.

### Kit fijación para tirador simple

CODIGO	REF.	
24779	104.9005.00.00	1

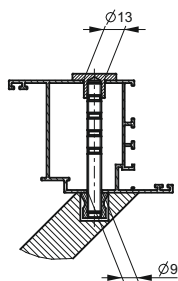

### Kit fijación para tirador simple

CODIGO	REF.	MEDIDA	
19693	104.0000.35.00	35mm	1
19683	104.0000.45.00	45mm	1
19684	104.0000.55.00	55mm	1

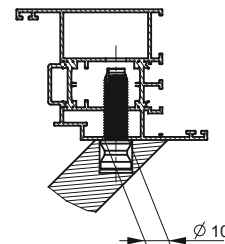

### Kit fijación para tirador doble

CODIGO	REF.	
24780	114.0000.00.10	1



## Asa BOOM

CODIGO	REF.	COLOR
■ 46	<b>BOOM</b>	Blanco
■ 48	<b>BOOM</b>	Negro
■ 49	<b>BOOM</b>	Lac Plata
■ 6798	<b>BOOM</b>	Lac Inox
■ 2396	<b>KIT simple</b>	-----



350

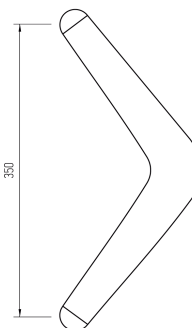

12

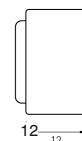

SIMPLE



DOBLE



**Nota:** Para solicitar 1 asa doble hay que pedir 2 unidades del mismo código, el kit ya viene dentro.

## Juego soporte + Kit para tirador T-42 + tornillería (incluye dos soportes y dos tapones pero no incluye el tubo)

CODIGO	REF.	COLOR
■ 9282	<b>T-42</b>	Inox brillo
■ 9283	<b>T-42</b>	Negro
■ 9524	<b>T-42</b>	Blanco
9525	<b>T-42</b>	Anod Plata mate



8

## ASA H Asa de acero inoxidable

MEDIDA	CODIGO SIMPLE	MEDIDA INTEREJE
25x300	■ 3	200mm
25x400	131	250mm



## Tubo inoxidable, diametro de 40.

CODIGO	REF.
■ 3744	<b>TUBO 40</b> (2.9 mts)
■ 14689	<b>TUBO 40</b> (2 mts)



## Juego soporte fijación ciego simple (2 piezas)

CODIGO	REF.
■ 3493	<b>6401</b>
4615	<b>6403 desplazado</b>



## Juego soporte fijación ciego doble (4 piezas)

CODIGO	REF.
■ 3494	<b>6402</b>
4616	<b>6404 desplazado</b>

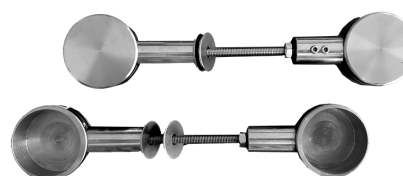

## Cierrapuertas DC110.

CODIGO	REF.	COLOR	BRAZO
■ 6933	Dc130	BLANCO	NORMAL
■ 6935	Dc130	NEGRO	NORMAL
■ 6937	Dc130	PLATA	NORMAL
■ 6934	Dc130	BLANCO	RETENEDOR
■ 6936	Dc130	NEGRO	RETENEDOR
■ 6938	Dc130	PLATA	RETENEDOR



## Características técnicas:

Fuerza variable:	En 3 y 4.
Ancho máximo de la puerta:	En 3 950mm En 4 1100mm
Peso puerta:	En 3 45 / 60 kg En 4 60 / 80 kg
Velocidad de cierre y golpe final regulable con dos válvulas independientes:	180° - 10° 10° - 0°

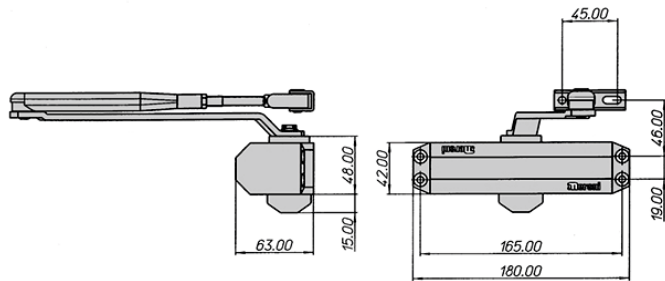

Nota: Producto que cumple con la EN 1154 y EN 1634

## Cierrapuertas DC310.

CODIGO	REF.	COLOR	BRAZO
10388	DC310	BLANCO	NORMAL
6939	DC310	NEGRO	NORMAL
6941	DC310	PLATA	NORMAL
■ 9798	DC310	BLANCO	RETENEDOR
■ 6940	DC310	NEGRO	RETENEDOR
■ 6942	DC310	PLATA	RETENEDOR



## Características técnicas:

Fuerza regulable:	En 2, 3, 4 y 5
Ancho máximo de la puerta:	En 2 850mm En 3 950mm En 4 1100mm En 5 1250mm
Peso puerta:	En 2 25 / 45 kg En 3 45 / 60 kg En 4 60 / 80 kg En 5 80/110 kg
Velocidad de cierre y golpe final regulable con dos válvulas independientes:	180° - 10° 10° - 0°

## Cierrapuertas Dc310 brazo deslizante con freno.

CODIGO	REF.	COLOR	BRAZO
12563	DC310	BLANCO	DESLIZANTE/RETENEDOR
10031	DC310	NEGRO	DESLIZANTE/RETENEDOR
10249	DC310	PLATA	DESLIZANTE/RETENEDOR

## DETALLE BRAZO DESLIZANTE:



Producto certificado con la norma EN 1154 y EN 1634

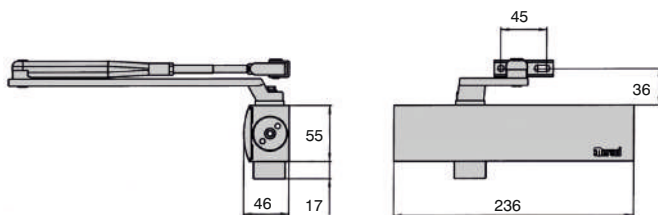

## Selector de cierre.

CODIGO	REF.
■ 13104	07084-11

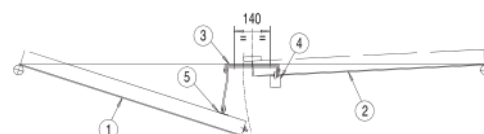
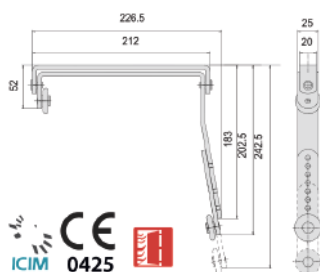

**NOTA:** Con el brazo deslizante baja un punto la fuerza. Quitando el tope del brazo deslizante se puede hacer un cierrapuertas sin retención.

## Cierrapuertas 5210 con retención.

CODIGO	REF.	COLOR	
20414	5210.45	BLANCO	1
20413	5210.44	NEGRO	1
20415	5210.97	PLATA	1

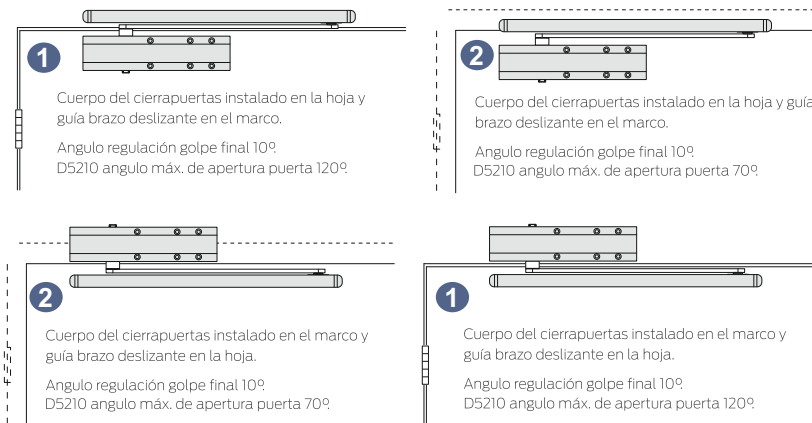

- 1** Apertura interior
- 2** Apertura exterior

Cierrapuertas aéreo con brazo de guía deslizante que incorpora un dispositivo de retención mecánica regulable. El ángulo de retención está comprendido entre 70° y 120°, en función de la tipología de instalación del cierrapuertas la puerta puede ser liberada manualmente desde la posición de parada.

La versión con retención mecánica NO es apta para instalación en puertas cortafuego.

Es posible quitar el dispositivo de retención. Sin la retención el ángulo máximo de apertura va de 180 a 140° dependiendo del montaje.

- Regulación fuerza de cierre
- Regulación fuerza EN 1-4
- Regulación velocidad de cierre
- Regulación golpe final

## Cierrapuertas suelo Fs1 (incluye los brazos)

CODIGO	REF.
21552	Fs1

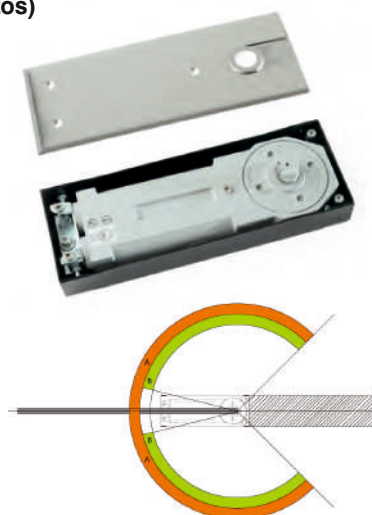

A - Rango primario de ajuste 130° a 0°  
B - Rango secundario de ajuste 130° a 20°

CARACTERÍSTICAS TÉCNICAS	FS1
Fuerza de cierre	EN 1-4
Anchura de la puerta (mm)	<1100 mm
Peso de la puerta	<120 Kg
Certificación fuego	NO
Versión igual a derecha e izquierda	SI
Estilo de diseño	Cierrapuertas 1 de suelo
Instalación tipo estándar	-
Instalación en brazo paralelo	-
Instalación en marco superior	-
Velocidades de cierre regulables mediante ajuste	SI
Material	Hierro
Distancia de agujeros de montaje horizontal	-
Distancia de agujeros de montaje vertical	-
Amortiguación de apertura	SI
Brazo deslizante	NO
Retardo en el cierre	NO
Ciclos testados	-
Fijación	NO

## Cortaviento IGLOO embutido para colocación en hojas de CE guiado por el canal.

CODIGO	REF.	LARGO	CORTE
■ 19216	DA0581040	400	max = 50
■ 19217	DA0581050	500	max = 100
■ 18368	DA0581060	600	max = 100
■ 17763	DA0581070	700	max = 100
■ 14063	DA0581080	800	max = 100
14062	DA0581090	900	max = 100
14064	DA0581100	1000	max = 100
13829	DA0581110	1100	max = 100
■ 15600	DA0581120	1200	max = 100
■ 19219	DA0581130	1300	max = 100

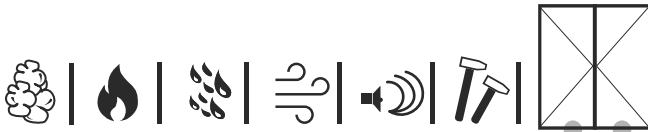
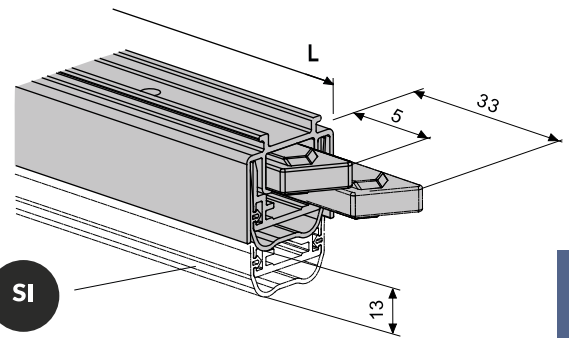
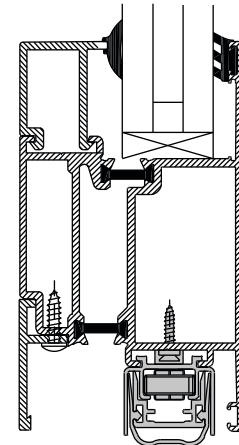
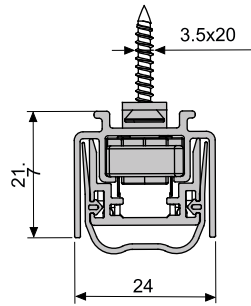

## Cortaviento FIRE embutido para colocación en zócalos aluminio de altura de 22mm )

CODIGO	REF.	LARGO	CORTE
■ 24666	DA6004060FR	600	max = 200
■ 21682	DA6004080FR	800	max = 200
21683	DA6004090FR	900	max = 200
■ 21680	DA6004100FR	1000	max = 200
18861	DA6004110FR	1100	max = 200

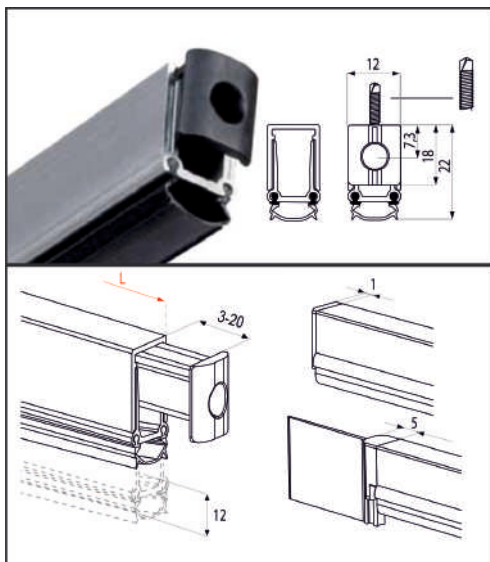
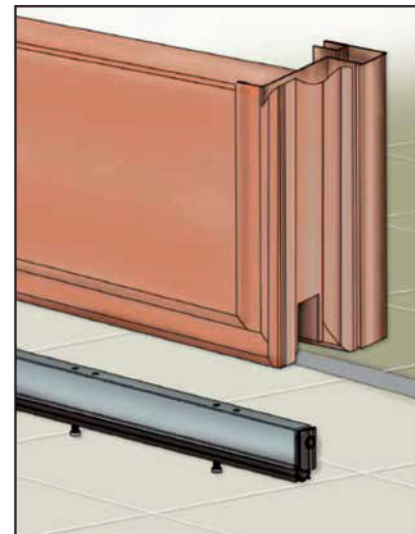

NOTA: Cortaviento Fire disponible también para altura de 30mm



## Cortaviento COMPACT superpuesto para todo tipo de puertas.

CODIGO	REF.	LARGO	CORTE	COLOR
■ 19226	DA3062040	400	max = 180	Blanco
■ 19224	DA3062040	400	max = 180	Negro
■ 18786	DA3062050	500	max = 200	Blanco
■ 17282	DA3062050	500	max = 200	Negro
■ 19227	DA3062060	600	max = 200	Blanco
■ 19228	DA3062060	600	max = 200	Negro
■ 19229	DA3062070	700	max = 200	Blanco
■ 17283	DA3062070	700	max = 200	Negro
■ 19231	DA3062080	800	max = 200	Blanco
■ 17307	DA3062080	800	max = 200	Negro
18926	DA3062090	900	max = 200	Blanco
15446	DA3062090	900	max = 200	Negro
■ 14874	DA3062100	1000	max = 200	Blanco
■ 15107	DA3062100	1000	max = 200	Negro
19232	DA3062110	1100	max = 200	Blanco
15142	DA3062110	1100	max = 200	Negro
■ 19233	DA3062120	1200	max = 200	Blanco
■ 18501	DA3062120	1200	max = 200	Negro
■ 19235	DA3062130	1300	max = 200	Blanco
■ 18502	DA3062130	1300	max = 200	Negro

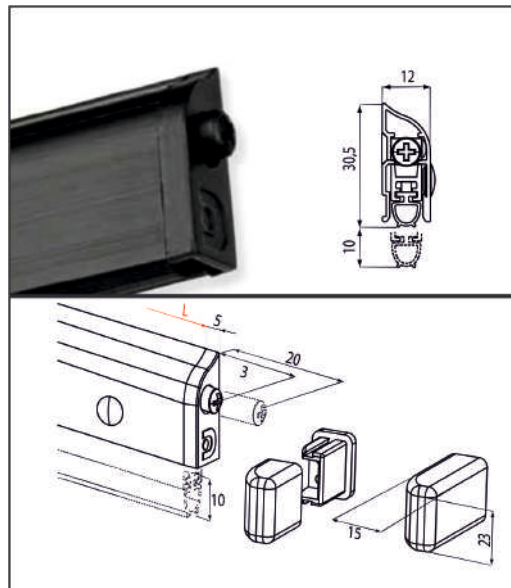

## Solera D RAIN exterior atornillada al suelo

CODIGO	REF.	LARGO	CORTE	COLOR
■ 17328	DF9900A_05	850	max 200 por cada lado	Plata
18532	DF9900B_05	1050		Plata
20190	DF9900C_05	1350		Plata
■ 20469	DF9900D_05	1650		Plata

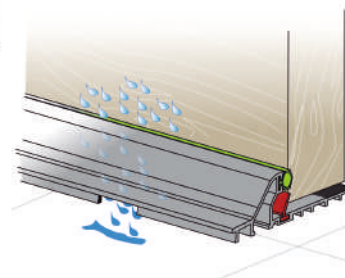
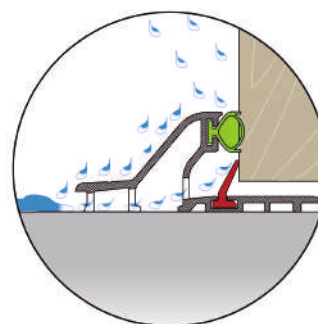
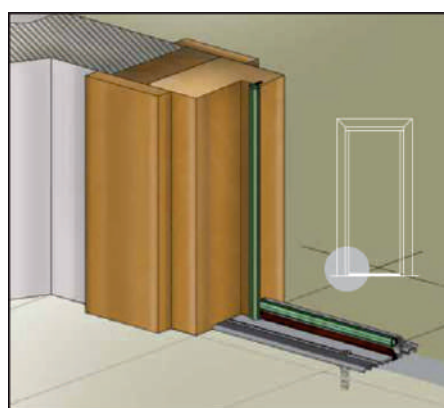



**Cierre presión con llave**

CODIGO	REF.	COLOR	
15202	3041.53	Blanco	10
14795	3041.53	Negro	10

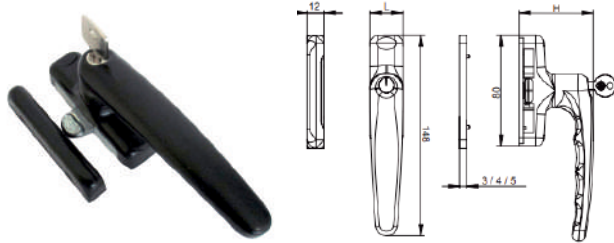

**Juego manilla recuperable en acero. (Jgo)**

CODIGO	REF.	COLOR	
2509	20010	Inox	2
122	20070	Inox	2



**Embellecedor cilindro rectangular en acero.**

CODIGO	REF.	COLOR
1363	20097	Inox

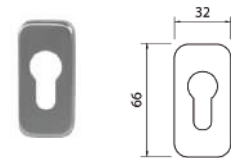

**Pomo recuperable**

CODIGO	REF.	COLOR	
19189	3297	Blanco	6
8814	3297	Negro	6

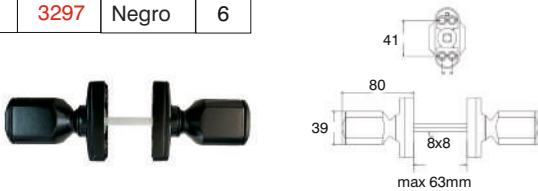

**Manilla Balconera. (Jgo)**

CODIGO	REF.	COLOR	
2556	BALCONERA	Blanco	40
2557	BALCONERA	Negro	40



**Cierre presión bajo especial para postigo o porticón.**

CODIGO	REF.	COLOR
12640	9565 dcha	Blanco
19015	9565 izda	Blanco
12641	9565 dcha	Negro
19016	9565 izda	Negro
19192	9565 dcha	Plata
19193	9565 izda	Plata
19194	9565 dcha	Inox
19195	9565 izda	Inox

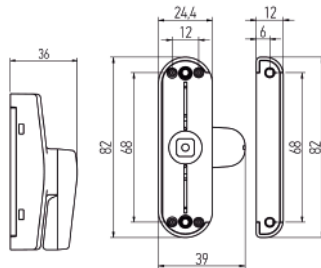

**Manilla recuperable SILUETE**

CODIGO	REF.	COLOR	
4546	11330	Blanco	5
4547	11330	Negro	5

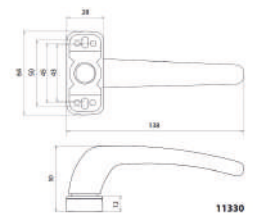

**Manilla recuperable plana SILUETE**

CODIGO	REF.	COLOR	
5324	11372	Blanco	5
5325	11372	Negro	5

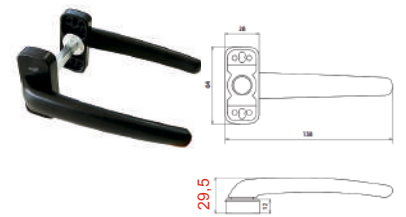

**NOTA:** Bisagra especial para postigo o porticón ver pag. 95

**Manilla con escudo. (Jgo)**

CODIGO	REF.	COLOR	
2513	20090	Inox	6

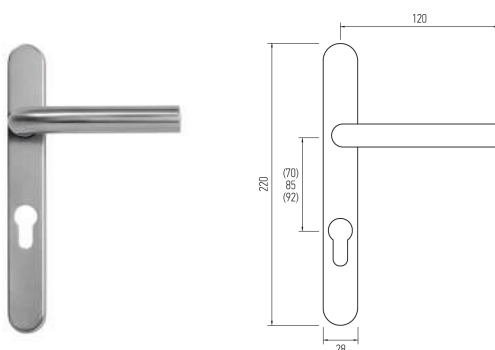

**Manilla con tirador (Jgo)**

CODIGO	REF.	COLOR	
6930	11221/85	Blanco	1
6931	11221/85	Negro	1

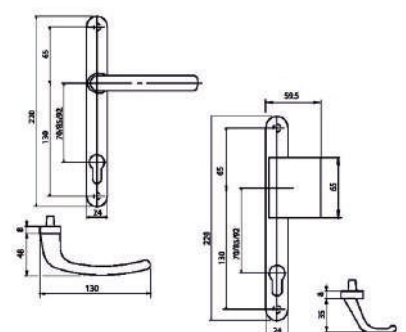



### DIMENSIONES MÁXIMAS Y PESOS:

- 200 Kg de peso máximo de hoja.
- 2.500mm de altura máxima (3.000 con el alargador)
- 1.300mm de anchura máxima

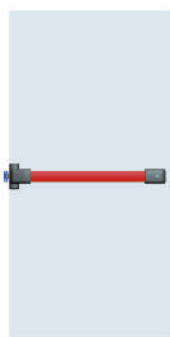

**ESCAPE 1**  
Antipánico 1 hoja  
Cierre lateral.

CÓDIGO	REF.
7325	ESCAPE1

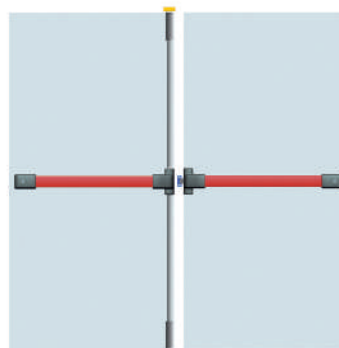

**ESCAPE 4 Y ESCAPE 1**  
Antipánico 2 hojas  
Cierre superior e inferior + Cierre lateral.

CÓDIGO	REF.
7325	ESCAPE1
9530	ESCAPE4 (2,5 mts)
15486	ESCAPE4 (3 mts)

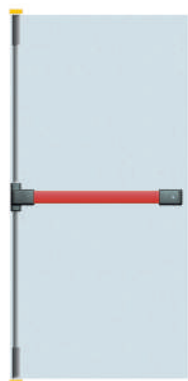

**ESCAPE 4**  
Antipánico 1 hoja  
Cierre superior e inferior.

CÓDIGO	REF.
9530	ESCAPE4 (2,5 mts)
15486	ESCAPE4 (3mts)

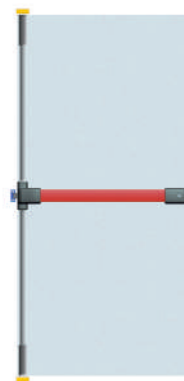

**ESCAPE 3**  
Antipánico 1 hoja  
Cierre superior, inferior  
y lateral.

CÓDIGO	REF.
9532	ESCAPE3 (2,5 mts)
15485	ESCAPE3 (3mts)

### Manilla con llave.

CÓDIGO	REF.
7326	H301
13107	H301 (llaves iguales)



### NOTA:

A todos los esquemas se les puede acoplar por el exterior la manilla con llave.



### DIMENSIONES MÁXIMAS Y PESOS:

- 200 Kg de peso máximo de hoja.
- 2.500 mm de altura máxima (con el alargador hasta 3.250)
- 1.300 mm de anchura máxima.

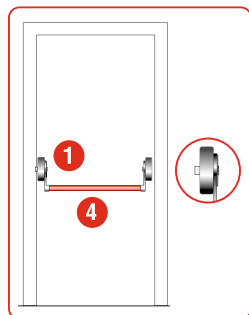

**Antipánico 1 punto**  
Cierre lateral.

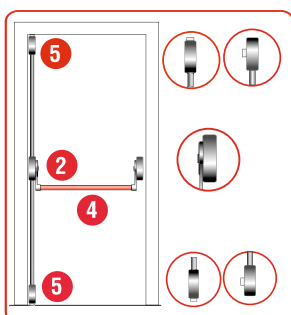

**Antipánico 2 puntos**  
Cierre superior e inferior o lateral

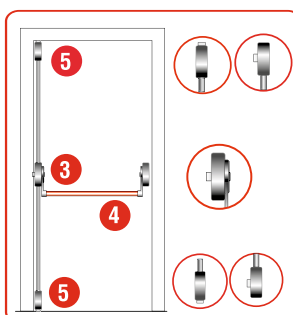

**Antipánico 3 puntos**  
Cierre 1 punto lateral y superior e inferior o 3 puntos laterales

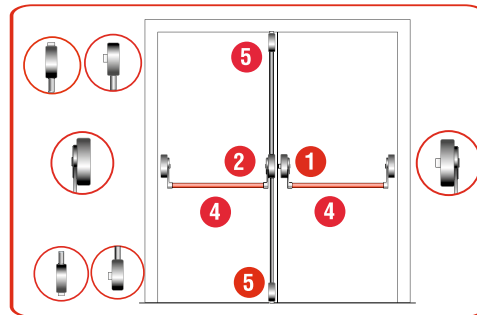

**Antipánico 2 hojas**

**1** Kit cierre central 1 punto.

CÓDIGO	REF.
■ 19237	59001-10-0

**2** Kit cierre central 2 puntos.

CÓDIGO	REF.
■ 19288	59016-10-0

**3** Kit cierre central 3 puntos.

CÓDIGO	REF.
■ 18850	59011-10-0

**4** Barra empuje roja.

CÓDIGO	REF.	MEDIDA
9045	07007-13-0	900mm
■ 16740	07007-14-0	1200mm
■ 19240	07007-15-0	1500mm

**5** Juego cierres suplementario

CÓDIGO	REF.	CIERRE
■ 9002	07063-61-0	sup/inf
■ 9553	07063-51-0	lateral

8



**NOTA:** Kit alargador de tubo para antipánico código 9188 (2500 < x < 3250mm).

### Manilla

CÓDIGO	REF.	
■ 5876	07078.68	
7718	07078.68E	llaves iguales 1-3-2-3-6



### Cerradero eléctrico (12v)

CÓDIGO	REF.
7649	07083.25



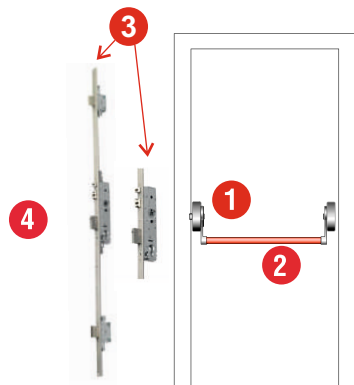

**Antipánico 1 hoja**

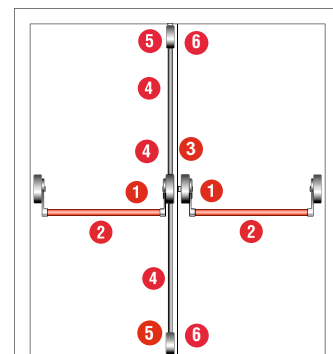
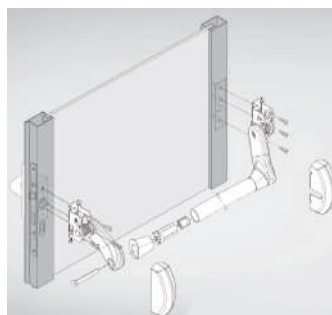

**Antipánico 2 hojas**

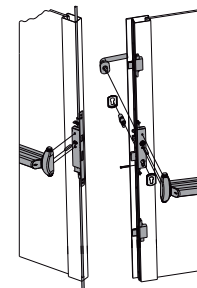

## 1

Antipánico de embutir Fast Push

CÓDIGO	REF.
■ 19367	1.59607.10.0

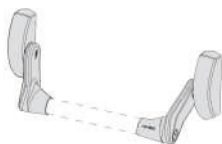

## 2

Barra empuje roja.

CÓDIGO	REF.	MEDIDA
9045	07007-13-0	900mm
16740	07007-14-0	1200mm
■ 19240	07007-15-0	1500mm



## 3

Cerradura 1 punto para antipánico embutir.

CÓDIGO	REF.	ENTRADA
■ 13269	43225.30	30
■ 11155	43225.35	35
■ 11366	43235.30	30
■ 15139	43235.35	35



Cerradura SIKUR 3 puntos para antipánico embutir.

CÓDIGO	REF.	FRENTE	ENTRADA
■ 16573	1.43725.35	—	35
■ 21368	1.43725.40	—	40



## 4

Cerradero central CE (solo para antipánico de una hoja)

CÓDIGO	REF.
812	06463.32.0

Contracerradura de embutir para antipánico de dos hojas .

CÓDIGO	REF.
■ 17367	43295.30
■ 21367	43295.40
■ 17030	43295.60



Cerradero sup/inf CE (solo para cerradura de 3 puntos)

CÓDIGO	REF.
814	06465.22.0

## 5

Varillas roscadas. Solo para antipánico de dos hojas

CÓDIGO	REF.
■ 13416	07088.03

## 6

Dispositivo de bloqueo para varillas.  
Solo para antipánico de dos hojas

CÓDIGO	REF.
■ 17031	07089.52

**NOTA:** El antipánico de embutir tiene diferentes opciones y montajes. Consultar con departamento comercial para más información.

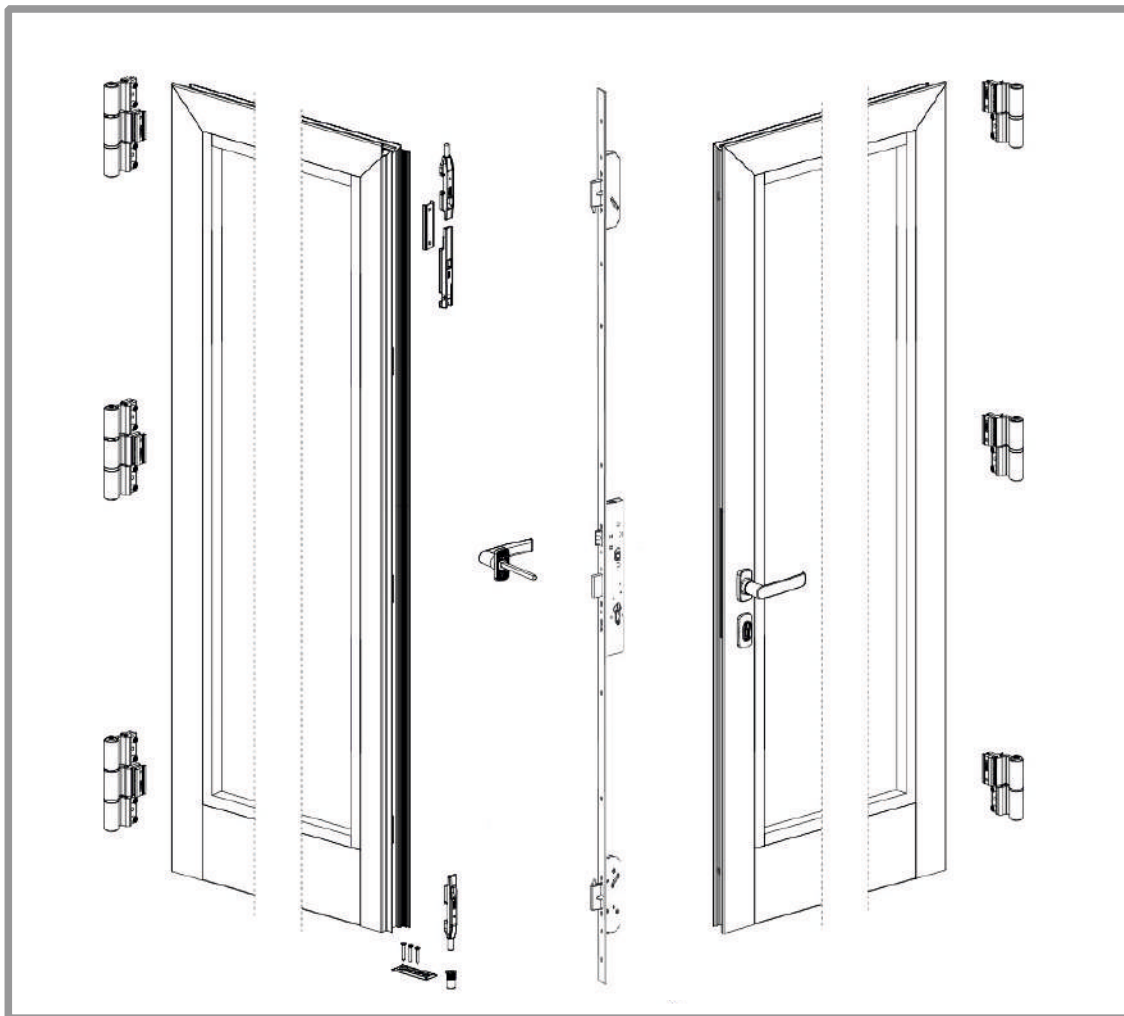

### Cerradura MULTITOP (FRENTE PLANO)

CODIGO	REF.	ENTRADA	
10161	49526	30mm	1
10265	49526	35mm	1
15335	49526	40mm	1

### Cerradero coplanar CENTRAL (regulable)

CODIGO	REF.	
13878	06463.74	10

### Cerradero coplanar superior / inferior

CODIGO	REF.	
13771	06465.24	10

### Características:

- 10 engranajes que aseguran un funcionamiento suave y un perfecto alineamiento de la puerta.



### Cerradura coplanar (frontal de 24mm)

CODIGO	REF.	ENTRADA	
14539	7716	30mm	1
14528	7716	35mm	1

### Cerradero coplanar CENTRAL

CODIGO	REF.	SERIE	FRONTAL	
23814	Ct3	7716	U	10
13770	06463.84	A		10

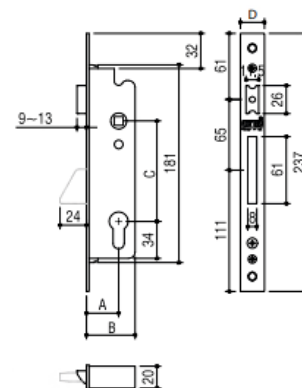
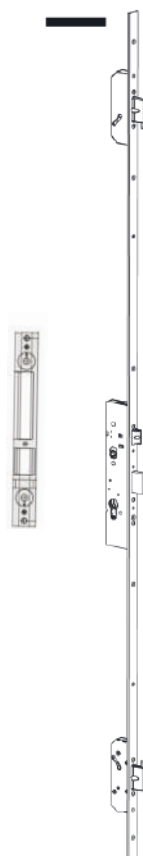

A	B	C	D
25mm	32 mm	85/92 mm	22/24mm
30mm	42 mm	85/92 mm	22/24mm
35mm	47 mm	85/92 mm	22/24mm

## Bisagra VELOX 2 palas

CODIGO	REF.	COLOR
12645	5520	Blanco
13367	5520	Negro
■ 14081	5520	Anod Plata
13368	5520	Anod Inox

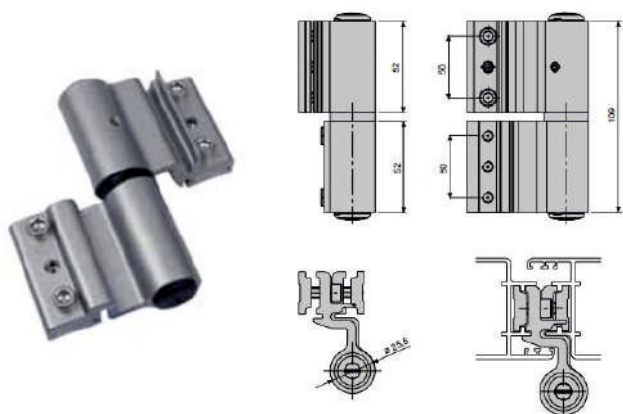

## Bisagra VELOX 3 palas

CODIGO	REF.	COLOR
13369	5521	Blanco
13370	5521	Negro
■ 13371	5521	Anod Plata
■ 13372	5521	Anod Inox

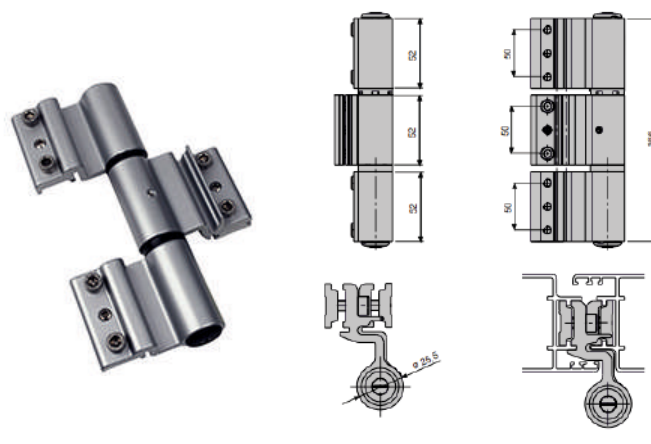

8

## Puntero para sistema VELOX (2ª hoja)

CODIGO	REF.	Icon
18522	5409	1

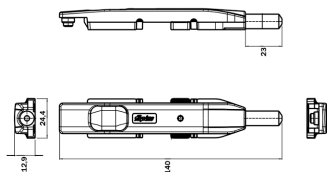

## Pasador para 2ª hoja para sistema VELOX

CODIGO	REF.	Icon
13378	5410	1



## Cerradero superior

CODIGO	REF.	Icon
13379	5413D	1

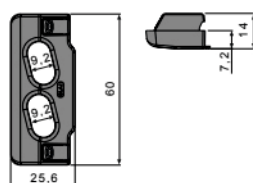

## Cerradero inferior suelo Velox

CODIGO	REF.	Icon
■ 13380	3738	1

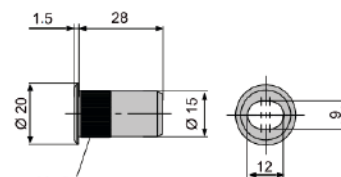

## Cerradero inferior

CODIGO	REF.	Icon
■ 13383	3734	10

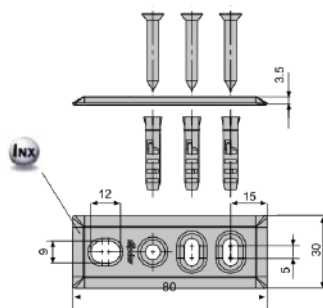

## Falleba para la 2ª hoja

CODIGO	REF.	MEDIDA	Icon
■ 13381	5411	265mm	25
■ 13382	54111	2000mm	25

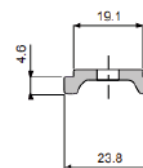





### ECODOOR

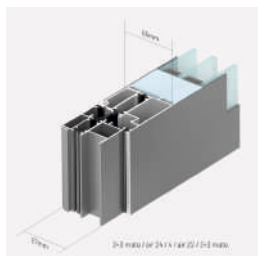

#### Sistema de puerta estandarizada con 2 modelos lisos y 2 con vidrio

- Solo 1 hoja
- Color blanco txt y gris 7016 txt
- Marco de aluminio con RPT
- Hoja de aluminio con RPT compuesta de chapa de aluminio interior/externo de 1.5mm de espesor y núcleo de poliestireno expandido de alta densidad.
- 2 Bisagras antipalanca
- Maneta inox y tirador inox redondo de 400mm (otras opciones disponibles)
- Cerradura de seguridad 3 puntos con 5 llaves de seguridad
- Medida estándar 950 x 2100

### PLUS DOOR

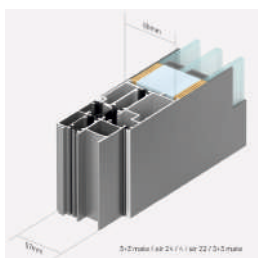

#### Sistema de puerta a medida con todos los modelos

- Solo 1 hoja y opcional fijos
- Fabricación a medida
- Altura máxima de 2300mm / Ancho máximo 1100 mm
- Todos los colores
- Marco de aluminio con RPT
- Hoja de aluminio con RPT compuesta de chapa de aluminio interior/externo de 1.5mm de espesor y núcleo compuesto de tablero de chopo 8mm + poliestireno expandido de alta densidad + tablero de chopo 8mm.
- 3 Bisagras antipalanca y maneta inox rectangular y tirador rectangular inox de 500mm.
- Cerradura de seguridad 3 puntos automática con 5 llaves de seguridad
- Opcional motorización/domótica

### PREMIUM DOOR

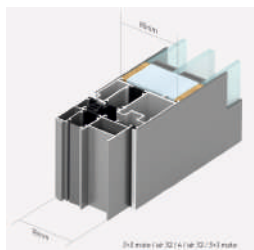

#### Sistema de puerta a medida con todos los modelos

- 1 y 2 hojas y opcional fijos
- Fabricación a medida
- Altura máxima de 2300mm bisagra oculta y 2700mm vista // Ancho máximo 1300 mm
- Todos los colores
- Hoja de aluminio RPT compuesta de chapa de aluminio interior/externo de 1.5mm de espesor y núcleo compuesto de tablero de chopo 8mm+ poliestireno expandido de alta densidad + tablero de chopo 8mm
- Bisagras ocultas y manetas inox rectangular y tirador inox rectangular de 1800mm (otras opciones disponibles)
- Cerradura de seguridad 4 puntos automática con 5 llaves de seguridad
- Opcional motorización/domótica

### Diferentes opciones:

#### Puerta de una hoja



#### Puerta de una hoja + fijos



#### Puerta de dos hojas



## Modelos para PLUS y PREMIUM DOOR:



## Acabados para PLUS y PREMIUM DOOR:



RAL  
9016TXT



RAL  
9005TXT



RAL  
7022TXT



RAL  
8014TXT



RAL  
1015TXT



RAL  
6009TXT



RAL  
7044TXT

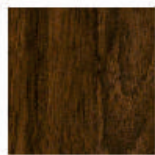

NOGAL  
EUROPEO  
TXT

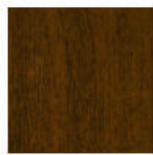

NOGAL  
OSCURO  
TXT



ROBLE  
RÚSTICO



ROBLE  
GOLDEN

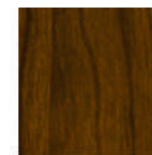

TEKA  
TXT

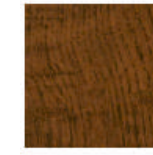

EMBERO  
TXT

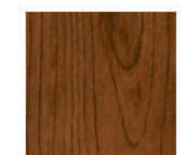

CEDRO

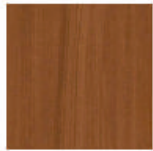

PINO  
ENVEJECIDO



ALASKAN



FORMENTERA

## Acesorios para PLUS y PREMIUM DOOR:

- Manilla redonda



- Tirador inox redondo 90º simple



- Manilla cuadrada



- Tirador inox rectangular 90º simple



- Mirilla



- Lector huella



**PUERTAS DISPONIBLES EN STOCK**

**Puerta ECO DOOR 1 hoja MODELO 02**

CODIGO	MEDIDA	COLOR	MANO
20550	950x2100	Blanco 9016 TXT	Derecha
20551	950X2100	Blanco 9016 TXT	Izquierda
20554	950X2100	7016 TXT	Derecha
20555	950X2100	7016 TXT	Izquierda



**Puerta ECO DOOR 1 hoja MODELO 03**

CODIGO	MEDIDA	COLOR	MANO
20552	950x2100	Blanco 9016 TXT	Derecha
20553	950X2100	Blanco 9016 TXT	Izquierda
20556	950X2100	7016 TXT	Derecha
20557	950X2100	7016 TXT	Izquierda



8

**IZQUIERDA**

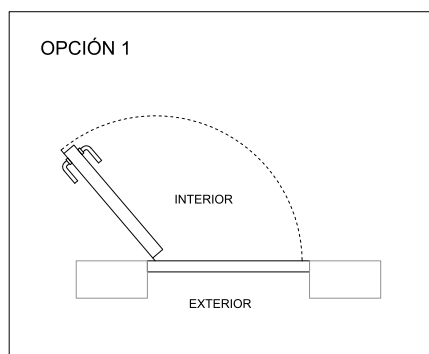

**DERECHA**

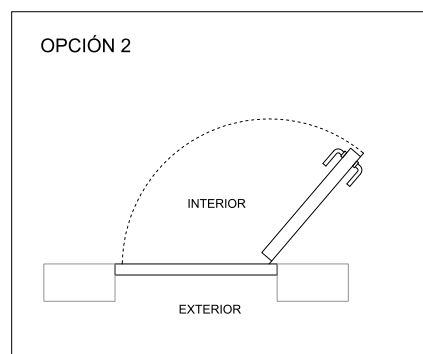

**Tirador inox redondo 90º simple**

CODIGO	MEDIDA
20764	400 mm
23599	1000 mm



**Tirador inox rectangular 90º simple**

CODIGO	MEDIDA
20960	500 mm
20902	1800 mm



**Pomo exterior**

CODIGO
21708



**NOTA:** Para más información solicite nuestro catálogo de puertas.

## Panel MODELO 1

CODIGO	MEDIDA	COLOR
10908	2000x800x20	Blanco 9016



## Panel MODELO 2

CODIGO	MEDIDA	COLOR
10768	2000x800x20	Blanco 9016
10762	2000x800x20	Blanco 9016 TXT
10764	2000x800x20	9005 TXT
10763	2000x800x20	7016 TXT
10760	2000c800c20	7022 TXT

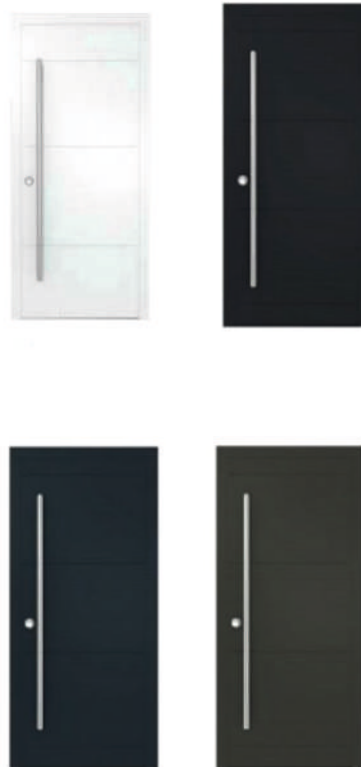

## Panel MODELO 3

CODIGO	MEDIDA	COLOR
24878	2000x800x20	Blanco 9016



## Panel MODELO 4 con rallas inox

CODIGO	MEDIDA	COLOR
10907	2000x800x20	Blanco 9016



## Motor VARIA SLIM para ventanas abatibles y proyectantes CON PULSADOR.

CODIGO	REF.	COLOR	
■ 12599	07889	Blanco	20
■ 12600	07889	Negro	20
■ 16652	07889	Gris	20

### Datos técnicos:

MODELO	VARIA SLIM BASE/230 V
Fuerza de empuje y tracción	250 N
Carreras (selección en cualquier momento)	240, 360 mm
Tensión de alimentación	110+230V (a.c.) 50/60Hz
Grado de protección dispositivos eléctricos	Ip30
Alimentación en paralelo de dos o más motores	Si (max 30 actuadores)
Medidas	356x56x33,5 mm

### Altura mínima de hoja en función de la carrera:

MODALIDAD DE INSTALACION	CARRERA	
	240	360
Cúpulas, claraboyas o ventanas verticales	400	550
Ventana proyectante con sujeción horizontal	400	550
Ventana abatible (motor en el bastidor)	400	550
Ventana abatible (motor en la hoja)	Consultar	



**NOTA:** ancho máximo de hoja 1200mm por motor

**NOTA:** PULSADOR NO INCLUIDO

## Motor CLOUD sincronizado para ventanas abatibles y proyectantes con PULSADOR (2 unidades por hoja)

16653	1120.62	Negro	1
18975	1120.62	Blanco	1
■ 15521	1120.62	Gris	1



**NOTA:** PULSADOR NO INCLUIDO

### Datos técnicos:

MODELO	CLOUD SYNCRO/230 V
Fuerza de empuje y tracción	300 N
Carreras (selección en cualquier momento)	100, 200, 400 mm
Tensión de alimentación	230V
Grado de protección dispositivos eléctricos	Ip30
Alimentación en paralelo de dos o más motores	Si
Medidas	386,5x59x37 mm

### Altura mínima de hoja en función de la carrera:

MODALIDAD DE INSTALACION	CARRERA	
	240	360
Cúpulas, claraboyas o ventanas verticales	400	550
Ventana proyectante con sujeción horizontal	400	550
Ventana abatible (motor en el bastidor)	400	550
Ventana abatible (motor en la hoja)	Consultar	

### Cálculo de la fuerza necesaria para accionamiento del bastidor\*:

- F** = Fuerza necesaria para abrir o cerrar (N)
- P** = Peso del bastidor (Kg)
- C** = Apertura del bastidor según carrera (mm)
- H** = Altura del bastidor (mm)

Formula de calculo para ventanas horizontales (claraboyas)

$$F = 5,4 \times P$$

Formula de calculo para ventanas verticales (abatibles y proyectantes)

$$F = (5,4 \times P) \times (C : H)$$



\* Este calculo no tiene en cuenta los factures externos al cerramiento, como por ejemplo los producidos por causas meteorológicas (cargas de nieve, viento, etc..)

### ATENCIÓN



En ventanas con apertura abatible hay peligro de lesiones provocadas por la caída accidental de la ventana. ES **OBLIGATORIO** montar un final de carrera de compás o un sistema de seguridad anticaída dimensionado de la forma apropiada para que resista a una fuerza igual al menos a tres veces el peso total de la ventana.



**NOTA:** Posibilidad de accionar los motores mediante aplicación para móvil.



## Motor VARIA SLIM RADIO para ventanas abatibles y proyectantes con receptor incluido.

CODIGO	REF.	COLOR	
20191	07888560	Blanco	1
18430	07888590	Negro	1
■ 18520	07888542	Gris	1

### Mando a distancia para motores con receptor incluido

CODIGO	REF.
18521	07892000

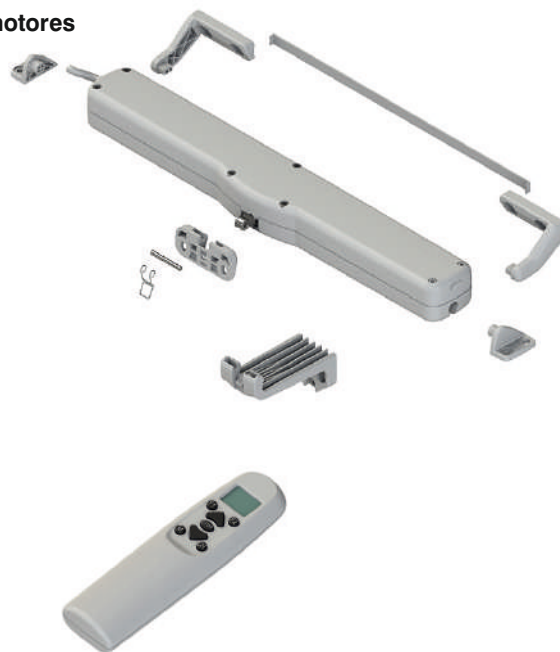

### Datos técnicos:

MODELO	VARIA SLIM RADIO
Fuerza de empuje y tracción	300 N
Carreras (selección en cualquier momento)	100, 200, 300, 400 mm
Tensión de alimentación	230V (a.c.) 50 Hz
Grado de protección dispositivos eléctricos	Ip30
Medidas	386,5x59x37 mm

### Altura mínima de hoja en función de la carrera:

MODALIDAD DE INSTALACION	CARRERA			
	100	200	300	400
Cúpulas, claraboyas o ventanas verticales	150	250	350	450
Ventana proyectante con sujeción horizontal	150	250	350	450
Ventana abatible (motor en el bastidor)	250	450	600	700
Ventana abatible (motor en la hoja)	Consultar			

## Motor WI CLOUD oculto

CODIGO	REF.
13605	A1121.2

### Adaptador para WI CLOUD para PVC y Canal16

CODIGO	REF.
14841	1121.55

### Transformador para motor WI CLOUD

CODIGO	REF.
16677	Tf7

### Pulsador para motor WI CLOUD

CODIGO	REF.
18442	1121.60



24V



### Datos técnicos:

MODELO	WI CLOUD
Fuerza de empuje y tracción	200 N
Carreras (selección en cualquier momento)	70, 125, 170, 210 mm
Tensión de alimentación	24V
Grado de protección dispositivos eléctricos	Ip32
Alimentación en paralelo de dos o más motores	No
Medidas	28X28X310 mm



**NOTA:** Posibilidad de accionar los motores mediante aplicación para móvil.

## Mando a distancia NEWTON con cuerda de 3mts

CODIGO	REF.	COLOR	
4242	F7 - NEWTON	Blanco	5
3317	F7 - NEWTON	Negro	5



## Perfil tapeta para cuerda NEWTON (605mm)

CODIGO	REF.	COLOR	
3352	F6R	Blanco	1
11306	F6R	Negro	1

## Cuerda 6 mts



CODIGO	REF.	COLOR	
15696	F6.ZB	Blanco	1
12773	F6.ZN	Negro	1

### DIMENSIONES Y PESO:

- de 400 a 1500 de ancho
- de 350 a 1600 de alto
- 80 kgs

## Mando a distancia VENTUS con palanca

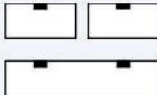
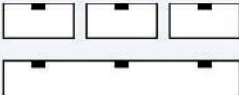

Accionamiento	Esquema 1	Esquema 2n	Esquema 3n	Esquema 4n																																																																			
																																																																							
Soporte de bastidor																																																																							
 <p>Accionamiento con manilla</p>	<table border="1"> <thead> <tr> <th colspan="4">Cantidad</th> <th rowspan="2">Descripción</th> <th rowspan="2">Blanco</th> <th rowspan="2">Negro</th> <th rowspan="2">Plata</th> </tr> <tr> <th>1</th> <th>2n</th> <th>3n</th> <th>4n</th> </tr> </thead> <tbody> <tr> <td>1</td> <td>1</td> <td>1</td> <td>1</td> <td>Guarnición base VENTUS F200</td> <td>6181</td> <td>6060</td> <td>7400</td> </tr> <tr> <td></td> <td>1</td> <td>2</td> <td>3</td> <td>Bolsa de compás VENTUS F200</td> <td>6156</td> <td>6061</td> <td>7401</td> </tr> <tr> <td>1</td> <td>2</td> <td>3</td> <td>4</td> <td>Cajita de soporte de bastidor VENTS F200</td> <td>6182</td> <td>6063</td> <td>7402</td> </tr> <tr> <td>1</td> <td>1</td> <td>1</td> <td>1</td> <td>Barra vertical y horizontal</td> <td></td> <td></td> <td>5071 5072 2X5072+14870</td> </tr> <tr> <td rowspan="2">1</td> <td rowspan="2">1</td> <td rowspan="2">1</td> <td rowspan="2">1</td> <td rowspan="2">Perfil de recubrimiento</td> <td>1800 mm</td> <td>6183</td> <td>10268</td> <td>19243</td> </tr> <tr> <td>3050 mm</td> <td>7559</td> <td>9150</td> <td>7403</td> </tr> <tr> <td></td> <td></td> <td></td> <td></td> <td>6000 mm</td> <td></td> <td></td> <td></td> </tr> </tbody> </table>			Cantidad				Descripción	Blanco	Negro	Plata	1	2n	3n	4n	1	1	1	1	Guarnición base VENTUS F200	6181	6060	7400		1	2	3	Bolsa de compás VENTUS F200	6156	6061	7401	1	2	3	4	Cajita de soporte de bastidor VENTS F200	6182	6063	7402	1	1	1	1	Barra vertical y horizontal			5071 5072 2X5072+14870	1	1	1	1	Perfil de recubrimiento	1800 mm	6183	10268	19243	3050 mm	7559	9150	7403					6000 mm						
	Cantidad				Descripción	Blanco	Negro					Plata																																																											
	1	2n	3n	4n																																																																			
	1	1	1	1	Guarnición base VENTUS F200	6181	6060	7400																																																															
		1	2	3	Bolsa de compás VENTUS F200	6156	6061	7401																																																															
	1	2	3	4	Cajita de soporte de bastidor VENTS F200	6182	6063	7402																																																															
	1	1	1	1	Barra vertical y horizontal			5071 5072 2X5072+14870																																																															
1	1	1	1	Perfil de recubrimiento	1800 mm	6183	10268	19243																																																															
					3050 mm	7559	9150	7403																																																															
				6000 mm																																																																			
<p><b>Altura minima 250mm</b>  <b>Anchura en apertura 165 / 200mm</b></p> <p><b>80 kgs (40kgs /m2)</b></p>																																																																							
<p><b>Anchura del bastidor FB</b>  400 – 1200 mm: 1 compás, esquema 1  1201 – 2400 mm: 2 compases, esquema 2n  2401 – 3600 mm: 3 compases, esquema 3n  2401 – 3600 mm: 4 compases, esquema 4n</p>																																																																							

**Goma hoja EPDM.**

CODIGO	REF.	BASE	
5065	DD18 EPDM	4,2 mm	280
■ 4391	DD18 EPDM	4,7 mm	400
5066	DD18 EPDM	5,5 mm	280



**Goma hoja TERMOPLÁSTICA.**

CODIGO	REF.	BASE	
■ 2240	Dd18	4,2 mm	200
■ 2241	Dd18	4,7 mm	200
2267	Dd18	4,9 mm	200
■ 2242	Dd18	5,5 mm	200



**Goma EPDM para hoja clipada**

CODIGO	REF.	BASE	
11264	4029	4,7mm	200



**Goma EPDM para hoja clipada**

CODIGO	REF.	BASE	
■ 8400	4078	5,5mm	300



**Goma TPE marco / hoja**

CODIGO	REF.	BASE	
■ 132	DD2	4,5 mm	250
■ 9051	DD2	4,7 mm	250
2	DD2	5,5 mm	250
4878	DD2	6,5 mm	250
2243	DD2	8,9 mm	250



**Goma TPE para marco y hoja, series 40x20, 40x40 y 40x18 mm.**

CODIGO	REF.	BASE	
2245	DD22	4,7 mm	250
2246	DD22	5,1 mm	250
2247	DD22	5,5 mm	250
2249	DD22	6,5 mm	250
2250	DD22	6,8 mm	250
2252	DD22	8,5 mm	200
2253	DD22	8,7 mm	200
2254	DD22	8,9 mm	200
2255	DD22	9,1 mm	200



**Goma TPE para marco y hoja carpinterías series 40x20, 40x40 y 40x18 mm.**

CODIGO	REF.	BASE	
2256	DD29	5,5 mm	250
2257	DD29	6,5 mm	250
10505	DD29	8,5 mm	250
2258	DD29	8,7 mm	200
2259	DD29	8,9 mm	200
2260	DD29	9,1 mm	200



**Goma burbuja expandido EPDM para lama P70.**

CODIGO	REF.	
4392	P70 EPDM	700



**Goma para lama de mallorquina TPE**

CODIGO	REF.	
■ 2186	DD58	300



**Juntas de goma PVC para acristalamiento**  
Goma de cuña negra.

CODIGO	REF.	HUECO	
■ 13123	N6	2 mm	200
■ 2235	N7	2.5 mm	200
■ 2236	N8	2.8 mm	100
■ 2237	N9	3.2 mm	100
■ 2211	N10	3.6 mm	100
■ 2214	N11	4 mm	100
■ 2216	N12	4.5 mm	100
■ 2217	N13	5 mm	100
■ 2219	N14	5.5 mm	100

CODIGO	REF.	HUECO	
■ 2220	N15	6 mm	100
■ 2223	N16	6.5 mm	100
■ 2225	N17	7.2 mm	100
■ 2227	N18	7.8 mm	100
■ 2228	N19	8 mm	100
■ 2229	N20	8,7 mm	100
■ 2231	N21	9.3 mm	100
■ 2232	N22	10 mm	100
■ 2234	N23	10.5 mm	100



10

**Goma PVC terminal persiana**

CODIGO	BASE	
3722	4,7 mm	200
■ 7154	4,9 mm	200
7725	5,2 mm	200



**Goma guía autoblocante**

CODIGO	REF.	BASE	
6096	Ps45	6,8mm	300



**Goma PVC mosquitera**

CODIGO	REF.	BASE
2273	3002	5 mm
2272	3002	5,5 mm
2275	3002	6 mm
2274	3002	6,5 mm
2276	3002	7 mm

200



**Goma mosquitera extremos diferentes**

CODIGO	REF.	
■ 2270	3003	----- 400



## ALCAR INALSA

### SERIES AE0931 - AE0932 - AE0941

#### Junta central EPDM.

CODIGO	REF.	
14291	E-237	150



#### Junta hoja EPDM

CODIGO	REF.	BASE		
5065	DD 18	4,2mm	EPDM	280
2240	DD 18	4,2mm	TERM	200



### SERIES AE0940

#### Junta central EPDM.

CODIGO	REF.	
14433	E-777	75



#### Junta hoja EPDM

CODIGO	REF.	BASE		
5065	DD 18	4,2mm	EPDM	280
2240	DD 18	4,2mm	TERM	200



### SERIES AE0943 - - AE0944

#### Junta central EPDM.

CODIGO	REF.	
14434	E-1096	50



#### Junta hoja EPDM

CODIGO	REF.	BASE		
5065	DD 18	4,2mm	EPDM	280
2240	DD 18	4,2mm	TERM	200



10

### SERIE INALSA 4040

#### Junta central EPDM.

CODIGO	REF.	
14726	E-240	150



#### Junta hoja EPDM o TERMOPLASTICA.

CODIGO	REF.	BASE		
■ 4391	DD 18	4,7mm	EPDM	400
■ 2241	DD 18	4,7mm	TERM.	200
11264	4029	clipada	EPDM	200



#### Ángulo vulcanizado.

CODIGO	REF.	
-----	-----	---



## ALUMED SISTEMAS

### SERIE P40 - P45

#### Junta central EPDM.

CODIGO	REF.	
■ 4988	V4	100

#### Junta acristalar EPDM.

CODIGO	REF.	
23337	173	200

#### Junta exterior

CODIGO	REF.	BASE		
■ 9051	DD 2	4,7mm	EPDM	250
24368	V14		EPDM	300

#### Junta hoja

CODIGO	REF.	BASE		
■ 4391	DD 18	4,7mm	EPDM	400
■ 2241	DD 18	4,7mm	TERM.	200
11264	4029	clipada	EPDM	200

#### Ángulo vulcanizado.

CODIGO	REF.	
7844	P40 P45	100

### SERIE OMEGA THERMIC - GPR 45 GALISUR

#### Junta central EPDM.

CODIGO	REF.	
■ 18941	41305	75

#### Junta acristalar EPDM.

CODIGO	REF.	
23337	173	200

#### Junta hoja EPDM / Marco exterior

CODIGO	REF.	
■ 18942	01	300

#### Junta hoja

CODIGO	REF.	BASE		
■ 4391	DD 18	4,7mm	EPDM	400
■ 2241	DD 18	4,7mm	TERM.	200
11264	4029	clipada	EPDM	200

#### Ángulo vulcanizado.

CODIGO	REF.	
■ 19417	E-776	100

### SERIE TECNICA

#### Goma Tapacarril

CODIGO	REF.	
21585	02551	200

## AYUSO

### SERIE AYUSO EURORACTIC 40-45 Y EURO THERMIC Y PT50

#### Junta central EPDM.

CODIGO	REF.	
7240	E-388	100

#### Junta hoja EPDM

CODIGO	REF.	BASE		
5065	DD 18	4,2mm	EPDM	280
2240	DD 18	4,2mm	TERM.	200

#### Exterior marco

CODIGO	REF.	
12485	242	300

#### Ángulo vulcanizado.

CODIGO	REF.	
-----	-----	---

#### Junta acristalar EPDM.

CODIGO	REF.	
17011	E-34	200

### SERIE PT60 AYUSO

#### Junta central EPDM.

CODIGO	REF.	
13840	4022	80

#### Junta hoja EPDM

CODIGO	REF.	BASE		
5065	DD 18	4,2mm	EPDM	280
2240	DD 18	4,2mm	TERM.	200

#### Exterior marco

CODIGO	REF.	
12485	242	300

#### Ángulo vulcanizado.

CODIGO	REF.	
-----	-----	---

#### Junta acristalar EPDM.

CODIGO	REF.	
17011	E-34	200



## ALUMINIOS BARCELONA

### SERIE ALBA 65 RPTE CE/ ALBA 65 RPT C16

#### Junta central EPDM.

CODIGO	REF.	
24125	V-15	100



#### Junta hoja / marco exterior

CODIGO	REF.	BASE		
5065	DD 18	4,2mm	EPDM	400
2240	DD 18	4,2mm	TERM.	200



#### Junta marco exterior clipada

CODIGO	REF.	
24124	V-17	250



#### Junta acristalar EPDM.

CODIGO	REF.	
17011	E-34	200



#### Junta exterior

CODIGO	REF.	BASE		
4878	DD 2	6,5mm	EPDM	250



### SERIE ALBA PROS 70 RPT Y 85 RPT

#### Junta tapacarril

CODIGO	
24786	200



## CENTROALUM

### SERIE RENOVA PR40

10

#### Junta central EPDM.

CODIGO	REF.	
14542	4006	100



#### Junta hoja clipada EPDM

CODIGO	REF.	
14541	322	200



#### Junta hoja

CODIGO	REF.	BASE	
2250	DD 22	6,8mm	250



#### Ángulo vulcanizado.

CODIGO	REF.	
----	----	---



## THERMIA

### SERIE CR-40

#### Goma Tapacarril

CODIGO	REF.	
21331	V-13	150



## EXTRUAL - ALUVAL

### SERIE ALURPOM 22-28

#### Junta central EPDM.

CODIGO	REF.	SERIE	
■ 4759	----	AL-22-28	150



#### Junta hoja / marco exterior

CODIGO	REF.	BASE		
■ 4391	DD 18	4,7mm	EPDM	400
■ 2241	DD 18	4,7mm	TERM.	200
11264	4029	clipada	EPDM	200



#### Ángulo vulcanizado.

CODIGO	REF.	
■ 6549	----	100



#### Junta acristalar EPDM.

CODIGO	REF.	
23337	173	200



### SERIE ALUPROM 36

#### Junta central EPDM.

CODIGO	REF.	SERIE	
■ 15252	V-7	AL-36	50



#### Junta hoja / marco exterior

CODIGO	REF.	BASE		
■ 4391	DD 18	4,7mm	EPDM	400
■ 2241	DD 18	4,7mm	TERM.	200
11264	4029	clipada	EPDM	200



#### Junta acristalar EPDM.

CODIGO	REF.	
23337	173	200



#### Junta exterior

CODIGO	REF.		
15354	36/25	EPDM	250
24368	V14	EPDM	300



#### Ángulo vulcanizado.

CODIGO	REF.	
■ 23601	AR-S11	100



10

## EXTRUAL

### SERIE E-75

#### Goma Tapacarril

CODIGO	REF.	
■ 21584	V-9	200



#### Goma hoja lateral

CODIGO	REF.		
21586	V-10	EPDM	200



## EXPRAL / ALUCAR

### SERIE A96 - A96R EXPRAL / A96 ALUCAR

#### Junta central EPDM.

CODIGO	REF.	
7926	E-833	100



#### Junta hoja

CODIGO	REF.	BASE		
■ 4391	DD 18	4,7mm	EPDM	400
■ 2241	DD 18	4,7mm	TERM.	200
11264	4029	clipada	EPDM	200



#### Ángulo vulcanizado.

CODIGO	REF.	
----	----	150



## HIERROS JATIVA C16 / EXTOL C16

### CANAL 16 -45 / CANAL 16 RPT 50

#### Junta central EPDM.

CODIGO	REF.	
24123	-----	75



#### Junta hoja / marco exterior

CODIGO	REF.	BASE		
■ 4391	DD 18	4,7mm	EPDM	400
■ 2241	DD 18	4,7mm	TERM.	200
11264	4029	clipada	EPDM	200



#### Junta acristalar EPDM.

CODIGO	REF.	
23337	173	200



#### Junta marco exterior

CODIGO	REF.	BASE		
9051	DD 2	4,7mm	EPDM	250
24368	V14		EPDM	300

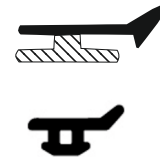

### SERIE CANAL 16 RPT 60/ CANAL 16 RPT 70 HO

#### Junta central EPDM.

CODIGO	REF.	
24122	-----	50



#### Junta hoja / marco exterior

CODIGO	REF.	BASE		
■ 4391	DD 18	4,7mm	EPDM	400
■ 2241	DD 18	4,7mm	TERM.	200
11264	4029	clipada	EPDM	200



#### Junta acristalar EPDM.

CODIGO	REF.	
23337	173	200



#### Junta marco exterior

CODIGO	REF.	BASE		
4878	DD 2	6,5mm	EPDM	250
24368	V14		EPDM	300

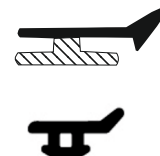

## PROVEEDORA

### MEZQUITA

#### Junta central EPDM.

CODIGO	REF.	
17856	E-153	200



#### Junta hoja / marco exterior

CODIGO	REF.	BASE		
■ 5065	DD 18	4,2mm	EPDM	400
■ 2240	DD 18	4,2mm	TERM.	200



## SISTEMAS CORTIZO Y ANICOLOR

### SERIE 2300 CORTIZO / AZ ANICOLOR / AX ANICOLOR

#### Junta central EPDM.

CODIGO	REF.	
18935	4000	150



#### Junta hoja

CODIGO	REF.	BASE		
8400	4078	clipada	EPDM	300
2242	DD 18	5,5mm	TERM.	200
5066	2003	5,5mm	EPDM	280



#### Exterior marco

CODIGO	REF.	
18936	4047	300



#### Junta acristalar hoja

CODIGO	REF.	
17011	E-34	200



#### Ángulo vulcanizado.

CODIGO	REF.	
19638	E-165	100



### SERIE 3000 CORTIZO / AXI ANICOLOR

#### Junta central EPDM.

CODIGO	REF.	
18938	4027	50

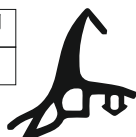

#### Junta hoja

CODIGO	REF.	BASE		
8400	4078	clipada	EPDM	300
2242	DD 18	5,5mm	TERM.	200
5066	2003	5,5mm	EPDM	280



#### Exterior marco

CODIGO	REF.	
18936	4047	300



#### Junta acristalar hoja

CODIGO	REF.	
17011	E-34	200



#### Ángulo vulcanizado.

CODIGO	REF.	
19640	E-220	100



### SERIE 3500 CORTIZO / ATI ANICOLOR

#### Junta central EPDM.

CODIGO	REF.	
18937	4498	50
24787	4042	200



#### Junta hoja

CODIGO	REF.	BASE		
8400	4078	clipada	EPDM	300
2242	DD 18	5,5mm	TERM.	200
5066	2003	5,5mm	EPDM	280



#### Exterior marco

CODIGO	REF.	
18936	4047	300



#### Junta acristalar hoja

CODIGO	REF.	
17011	E-34	200



#### Ángulo vulcanizado.

CODIGO	REF.
-----	-----



### SERIE COR 60/ AJI ANICOLOR / ARI ANICOLOR

#### Junta central EPDM.

CODIGO	REF.	
18939	4026	50



#### Junta hoja

CODIGO	REF.	BASE		
8400	4078	clipada	EPDM	300
2242	DD 18	5,5mm	TERM.	200
5066	2003	5,5mm	EPDM	280



#### Exterior marco

CODIGO	REF.	
18940	4032*	300



\* solo para la Cor 60

#### Junta acristalar hoja

CODIGO	REF.	
17011	E-34	200



#### Ángulo vulcanizado.

CODIGO	REF.	
19639	E-177	100



## ITESAL

### SERIE IT-40

#### Junta central EPDM.

CODIGO	REF.	
5067	V1	150



#### Junta hoja EPDM

CODIGO	REF.	BASE		
5065	DD 18	4,2mm	EPDM	280
2240	DD 18	4,2mm	TERM	200



#### Exterior marco

CODIGO	REF.	
12485	E-242	300



#### Junta exterior

CODIGO	REF.	BASE		
4878	DD 2	6,5mm	EPDM	250



#### Ángulo vulcanizado.

CODIGO	REF.	
7268	-----	100



### SERIES IT-45 RPT/ 52 RPT/ IT-61 RPT / 65 RPTO

#### Junta central EPDM.

CODIGO	REF.	
13125	E-390	100



#### Junta hoja EPDM

CODIGO	REF.	BASE		
5065	DD 18	4,2mm	EPDM	280
2240	DD 18	4,2mm	TERM	200



#### Exterior marco

CODIGO	REF.	
12485	E-242	150



#### Junta exterior

CODIGO	REF.	BASE		
4878	DD 2	6,5mm	EPDM	250



### SERIE EVO 61

#### Goma Tapacarril

CODIGO	REF.	
21331	V-13	150



10

## SIMER / EXLABESA

### SERIE 2500 SIMER/ALFIL 45/ 7000 Y 7400 EXLABESA

#### Junta central EPDM.

CODIGO	REF.	
13182	E-250	250



#### Junta hoja EPDM

CODIGO	REF.	BASE		
2242	Dd18	5,5mm	Exlabesa	400
11264	4029		Alfil 45	200



#### Exterior marco

CODIGO	REF.		
14025	312	Exlabesa 7000	400
12485	242	Exlabesa 7400	200



#### Ángulo vulcanizado.

CODIGO	REF.	
-----	-----	250



## GRUPO SOPENA

### SERIE V-94 Y V-98

#### Junta central EPDM

CODIGO	REF.	
4963	V-3	150



#### Junta hoja

CODIGO	REF.	BASE		
4391	DD 18	4,7mm	EPDM	400
2241	DD 18	4,7mm	TERM.	200
11264	4029	clipada	EPDM	200



#### Junta exterior

CODIGO	REF.	BASE	
9051	DD 2	4,7mm	150

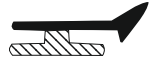

#### Junta acristalar hoja

CODIGO	REF.	BASE	
2239	DD 7	4,5mm	150



#### Ángulo vulcanizado

CODIGO	REF.	
6649	V-94	100



### SERIE V-98RT/ 45/54/ 98 RT

#### Junta central EPDM

CODIGO	REF.	
7501	V98	80



#### Junta hoja

CODIGO	REF.	BASE		
4391	DD 18	4,7mm	EPDM	400
2241	DD 18	4,7mm	TERM.	200
11264	4029	clipada	EPDM	200



#### Junta exterior

CODIGO	REF.	BASE	
9051	DD 2	4,7mm	150



#### Junta acristalar hoja

CODIGO	REF.	BASE	
2239	DD 7	4,5mm	150



#### Ángulo vulcanizado

CODIGO	REF.	
15598	5369	100



### SERIE V-98RT/67

#### Junta central EPDM

CODIGO	REF.	
5391	V98 - V67	90



#### Junta hoja

CODIGO	REF.	BASE		
4391	DD 18	4,7mm	EPDM	400
2241	DD 18	4,7mm	TERM.	200
11264	4029	clipada	EPDM	200



#### Junta exterior

CODIGO	REF.	BASE	
9051	DD 2	4,7mm	250



#### Junta acristalar hoja

CODIGO	REF.	BASE	
2239	DD 7	4,5mm	250



#### Ángulo vulcanizado

CODIGO	REF.	
18889	E-628	100



### SERIE 135 ELEVABLE

#### Goma hoja elevable

CODIGO	REF.	BASE	
9818	135821600	8,2mm	250





## Junta anti pinzados PEQUEÑA

CODIGO	REF.	COLOR	
7817	-----	NEGRO	2
7821	-----	GRIS	2

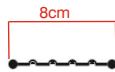

## Junta anti pinzados MEDIANA

CODIGO	REF.	COLOR	
7816	-----	NEGRO	2
7820	-----	GRIS	2

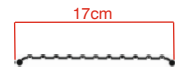

## Junta anti pinzados GRANDE

CODIGO	REF.	COLOR	
7818	-----	NEGRO	2
7819	-----	GRIS	2

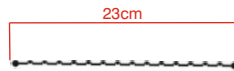

## Perfil aluminio para goma anti pinzados

CODIGO	REF.	
7822	-----	400



**NOTA:** Las gomas y los perfiles antipinzados se sirven en barras de 2mts.

### EJEMPLOS:

#### PUERTAS DE 90°

Goma pequeña

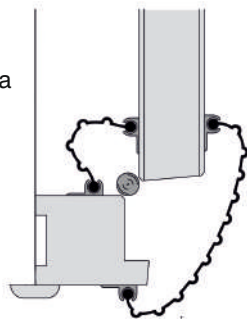

Goma mediana

#### PUERTAS DE 180°

Goma pequeña



Goma grande

#### PUERTAS VAIVEN

Goma grande

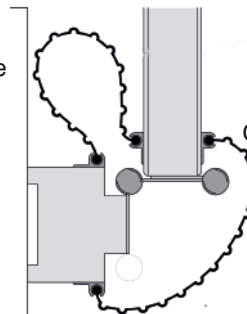

Goma grande

#### PUERTAS ALUMINIO

Goma mediana

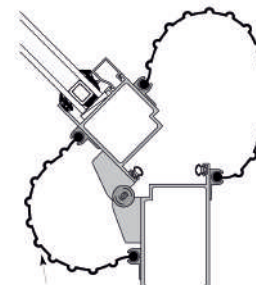

Goma grande

## Accesorios para gomas

### Ruleta nylon para goma central

CODIGO	REF.	
9268	-----	10



### Ruleta nylon mosquitera para goma

CODIGO	REF.	
7625	-----	1



### Tijeras para corte inglete

CODIGO	REF.	
3591	-----	1



# ESCUADRAS AMS

“La escuadra de calidad que mejor une”

Disponemos de todas las medidas y desplazamientos del mercado en tetón redondo y tetón cuadrado.

Modelos de gran resistencia y perfecta unión del inglete

Matriz neumática para el troquelado del perfil con gran facilidad en el cambio de medidas a troquelar según la cámara del perfil.



CODIGO	REF.
■ 4961	Matriz teton 8
13566	Matriz teton 6
13116	Matriz teton 5
19775	Matriz teton 4
8894	Placa guia



Posibilidad de fabricar escuadras con tetón de:

- 8mm
- 6mm
- 5mm
- 4mm



**NOTA:** También disponemos de matriz manual.

## Escuadra bloqueo tetón cuadrado

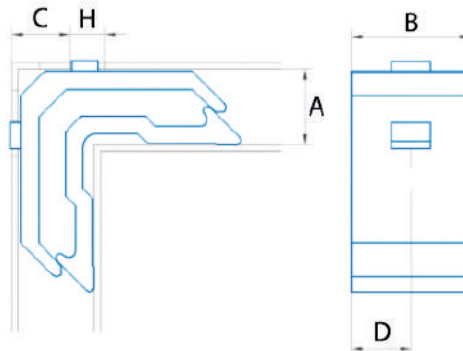
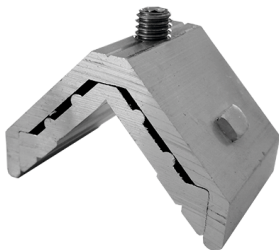

Escuadra Bloqueo Mecanizada  
Tetón Rectangular 8x6  
Prisionero M8 Inox-A2

A= 18 a 50 (tetón incluido)  
B= 10 a 45  
C= 27,5  
D= VARIABLE  
H= 9x8

**NOTA:** Disponemos de escuadras con diferente medida C. Consultar con departamento comercial.

## Escuadra bloqueo tetón redondo (tetón de 4, 5, 6 y 8mm)

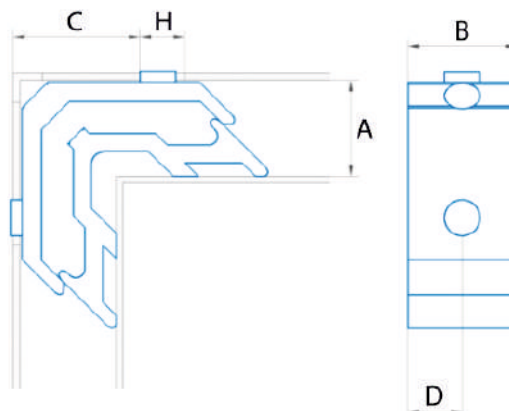

Escuadra Bloqueo Mecanizada  
Tetón Redondo Ø4,5,6 y 8  
Prisionero M8 Inox-A2

A= 15 a 50 (tetón incluido)  
B= 10 a 45  
C= 26,5  
D= VARIABLE  
H= 4,5,6 u 8

**NOTA:** Disponemos de escuadras con diferente medida C. Consultar con departamento comercial.

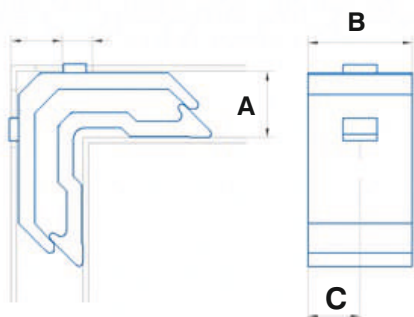

**ESCUADRAS DE TETON CUADRADO (8x6) CENTRADO**

CODIGO	REF. (ABC)	
■ 10557	1137-C/TC	250
■ 7334	1422-C/TC	250
■ 8426	1425-C/TC	250
■ 9047	14255-C/TC	300
■ 8427	1437-C/TC	180
■ 21458	1528-C/TC	250
■ 13973	1637-C/TC	160
■ 8958	2741-C-TC	180
■ 9134	3637-C/TC	150

**ESCUADRAS DE TETON CUADRADO (8x6) DESPLAZADO**

CODIGO	REF. (ABC)	
■ 5396	1437-150TC	180
8184	1442-150TC	150
■ 8160	1525-100/TC	250
■ 9358	1537-150TC	180
■ 5224	1637-150/TC	160
■ 8414	1837-150/TC	150
■ 8449	3137-150/TC	180
■ 8442	3637-150/TC	150
■ 9648	4025-100TC	220
8498	4037-150/TC	140
■ 5102	4237-150/TC	140

**ESCUADRAS DE TETON REDONDO CENTRADO 8 mm**

CODIGO	REF. (ABC)	
18818	10245-C	200
■ 8375	1025-C	400
■ 7977	1029-C	300
■ 5639	1121-C	200
■ 7662	1130-C	300
■ 5035	1137-C	220
■ 6410	1422-C	300
■ 7859	1423-C	300
4899	1425-C	250
8906	1426-C	250
■ 8444	1430-C	220
■ 5063	1437-C	180
5040	1525-C	250
■ 5043	1630-C	200
■ 4903	1637-C	160
■ 4911	1937-C	130
■ 6226	2137-C	250
■ 8423	2623-C	200
■ 5046	2737-C	250
■ 5047	3137-C	180
■ 5025	3637-C	150
■ 7407	4037-C	150

**ESCUADRAS DE TETON REDONDO DESPLAZADO 8mm**

CODIGO	REF. (ABC)	
■ 13867	1422-80	300
■ 5039	1425-80/H	260
■ 5038	1437-150	180
8362	1525-90	250
■ 5041	1542-170	180
■ 6070	1542-180	150
16709	1625-90	250
■ 4902	1637-150	160
■ 11439	3125-80	250
■ 4904	3137-150	180
■ 5050	3242-170	150
■ 6069	3242-180	150
■ 5051	3325-80	250
■ 5052	3637-150	150
■ 5116	4037-150	150
■ 8847	4225-80	200

**ESCUADRAS DE TETON REDONDO DE 4 Y 6mm**

CODIGO	REF. (ABC)	
■ 15279	6/4/1195-C	500
■ 19434	6/4/1495-C	400
12537	6/6/1112-C	300
■ 12503	6/6/1117-C	250
■ 8901	6/6/1218-C	250
9751	6/6/1412-C	250
■ 9899	6/6/1415-C	250
■ 9289	6/6/1420-C	350
■ 8981	6/6/1425-80	250
■ 8809	6/6/1511-C	300
10089	6/6/1512-C	300
11636	6/6/15215-80	250
10090	6/6/1522-C	300
■ 8904	6/6/1813-C	400
■ 9403	6/6/3115-C	220
■ 9900	6/6/3125-80	250



**ESCUADRA ESPECIAL 12.7x5,5mm TETON DE 3mm**

CODIGO	REF. (ABC)	
21955	49-055127-C	250

**NOTA:** series para la escuadra:  
 -IT-72 HO RPT C16  
 -IT-71 RPT C16  
 -IT-61 RPT C16  
 -IT-72 HO RPT  
 -IT-71 RPT  
 -IT-52 RPT  
 -IT-45 RPT



**MONTE BIANCO 1**      **FUJI**      **GRAN SASSO**



**MARMOLADA**

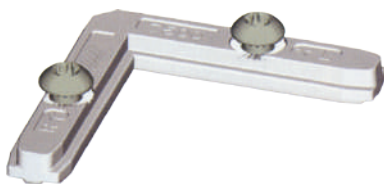

la squadra vincente  
la escuadra que convence

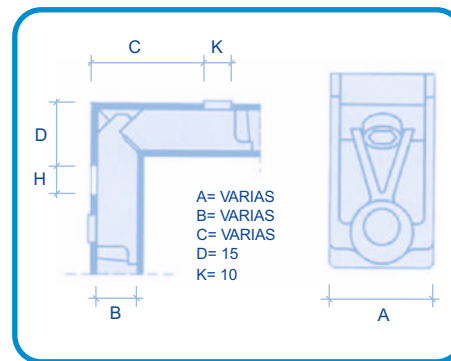

CODIGO	REF.	MEDIDA	
1385	200	35.9x13.8	250
5422	0315	23.9x10.5	250
1389	0333SX	37x15.8-150	250
1391	0356SX	36,8x13,8	250
1393	0363	20.3x17.3	250
8619	0367SX	36x29,2	250
■ 1401	0403	35.9x14.7	250
■ 1403	0404	23.9x10.5	250
1405	0406	36x30,5	250
1406	0407	36x35	200
1408	0409	28.5x14.5	250
1409	0410	23.3x14.5	250
1410	0417	22.4x10.4	250
1411	0420	36x15.5	250
■ 1412	0421	35.9x13.9	250
13675	0423	19x10,6	250
6627	0426	27,1X31,6	200
■ 1386	0427	16.8x14.3	250
1416	0430	51.2x14.5	200
■ 1420	0443	24x14	250

CODIGO	REF.	MEDIDA	
1421	0444	23,9x26	250
13329	0445	31,8x10,7	250
14038	0446	23,8x39,2	150
1423	0446.10/9	23,8x39,2	150
19425	0453	27,8x20,3	250
7430	0460.8L	13.8x11.8	250
1425	0478	36x35.5	150
■ 1428	0491	20.5x10.3	250
1429	0495	28x10.5	250
13080	4113.9	25,4x10,3	250
13081	4114.9	29,6x11,7	250
11572	4170	16x10,5	250
10681	A7101	8,9x11,2	250
1444	2007 (fuji)	7,1x15,2	250
9799	2008 (fuji)	4,8 X16,2	250
1445	2013 (fuji)	4.5x11.2	250
13103	2023 (fuji)	6,5x11,2	250
16849	0852	29,2X12	250
7151	0910.10	23,1x14	20
16862	1010	33,5x35,8	50

## Escuadra Europea

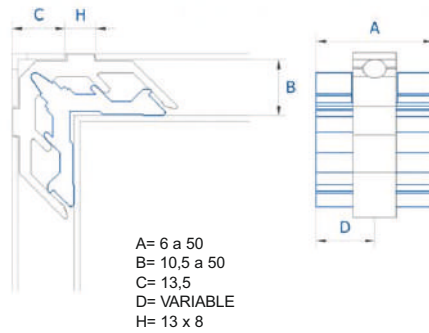

CODIGO	REF. (AB)	
10162	8-2910-C	250
1524	8-3714-C	200
1515	8-3714-150	200
1547	8-3716-C	200
1535	8-3716-150	200
10163	8-3721-C	150
1571	8-3731-C	100
3241	8-3731-150	100
1584	8-3736-C	100
1577	8-3736-150	100

## Escuadra graduable

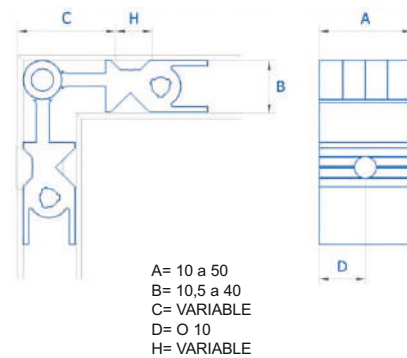

CODIGO	REF. (AB)	
953	12-2214-C	250
5191	12-2414-C	250
1459	12-2514-C	-
5255	12-3010-C	100
7164	12-3014-C	100
4400	12-3710-C	100
1510	12-3714-C	200
175	12-3731-C	50
1585	12-3736-C	50

**NOTA:** Especial para montajes de ángulos diferentes de 90°.

## Escuadra Tubular

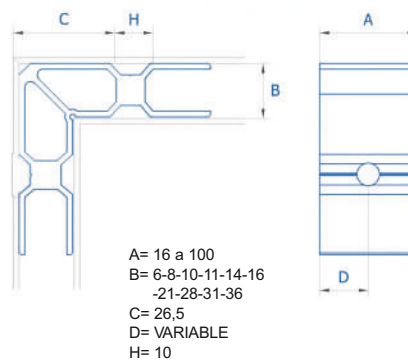

CODIGO	REF. (AB)	
7507	3-3714-C	150
1555	E03-3716-C	150
1591	E03-3736-C	100

## Escuadra tubular abierta

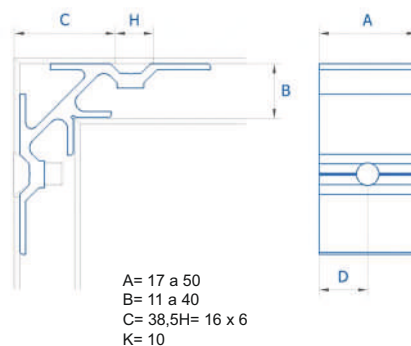

CODIGO	REF. (AB)	
8106	3714	250
1545	3716	250
1582	3736	150

Disponemos de escuadras y uniones para todas las series del mercado.  
Ver catálogo técnico.

## Escuadra Pivote

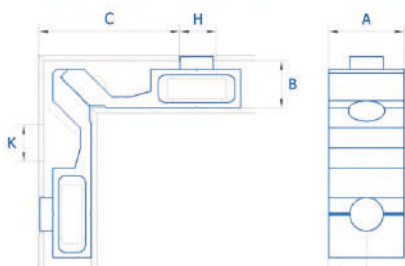

A= 17 a 50  
B= 11 a 40  
C= 38,5  
H= O10  
D= VARIABLE  
K= 16X6

CODIGO	REF.	
5189	10-1711	300
20726	10-2510	200
7319	10-2310	200
20725	10-2910 Int	200
20727	10-3715	100

## Unión Europea

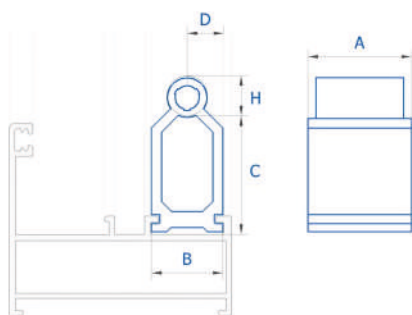
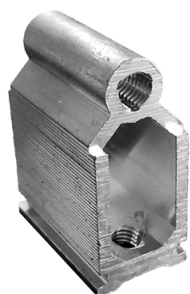

A= 5 a 100  
B= 18  
C= 26  
H= O 10  
D= 9

CODIGO	REF.	
3747	1118	200
3752	1418	200
3754	1518	200
3757	1618	200

CODIGO	REF.	
3774	3118	200
9344	3218	200
3776	3618	200
3786	3718	-
292	4018	200

## Unión Tubular

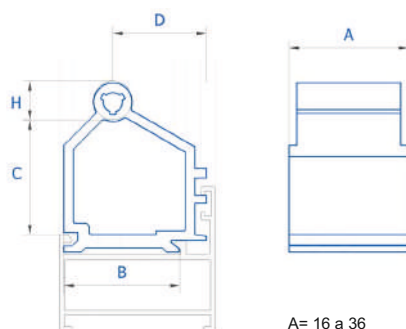

A= 16 a 36  
B= 37  
C= 29  
H= O 10  
D= 12,5

### Cerrada

CODIGO	REF.	
3784	1637 (4020)	250
3777	3637 (4040)	250

### Abierta

CODIGO	REF.	
3779	14-1637 (4020)	250
3778	14-3637 (4040)	250

## Union Europea Abierta

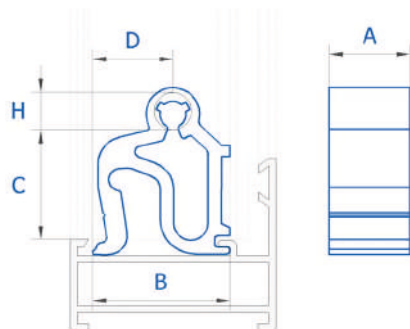
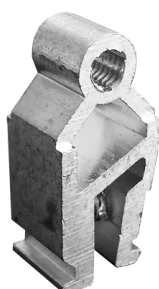

A= 14 a 36  
B= 18-37  
C= 26  
H= O 10  
D= 12,5

CODIGO	REF.	
3745	14-1118	200
3750	14-1218	-
3751	14-1418	200
3753	14-1518	200
3756	14-1618	200
3240	14-2618	200
7991	14-3018	200
3773	14-3118	200
3790	14-4018	200

Disponemos de escuadras y uniones para todas las series del mercado.



## Escuadra de alineación FIJACION FORRO F1. 12 x 2

CODIGO	REF.	
3668	F1	250

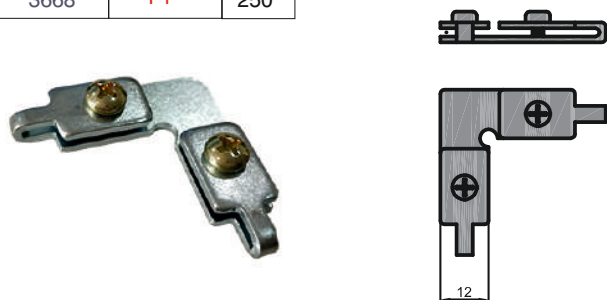

## Escuadra de alineación FIJACION FORRO F2. 10,6 x 1,5

CODIGO	REF.	
4275	F2	--

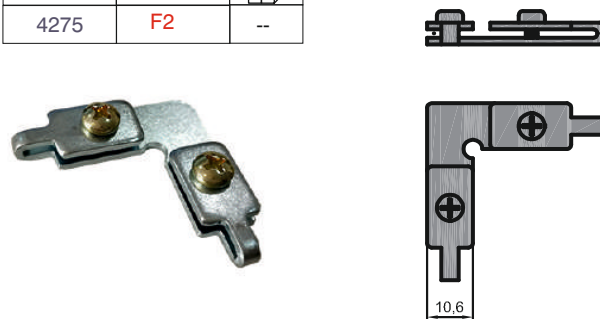

## Escuadra de alineación metálica. 9.1 x 0,8

CODIGO	REF.	
1641	2419608	250

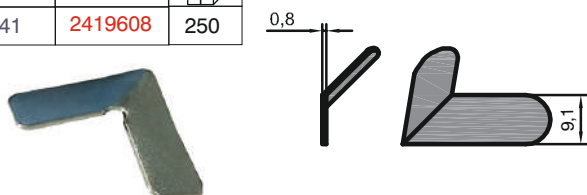

## Escuadra de alineación metálica. 4,8x0,5

CODIGO	REF.	
1642	2484805	1000

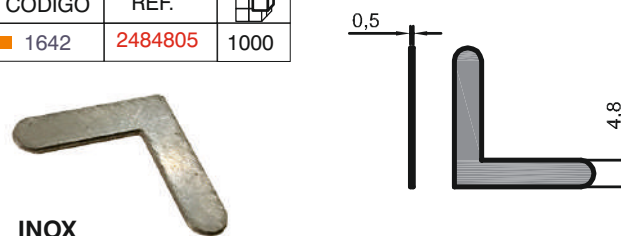

INOX

## Escuadra de alineación. 5 x 1 y 5 x2

CODIGO	REF.	
4948	5x1	500
6447	5x2	--

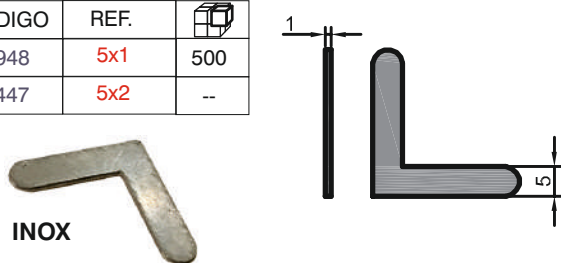

INOX

## Escuadra alineación. S/AI-18 6,8 x 0,5

CODIGO	REF.	
1640	2507106	500

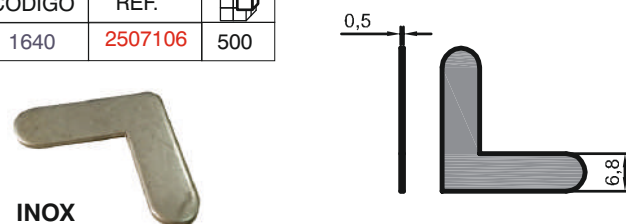

INOX

## Escuadra de alineación. 14,2 x 1,2

CODIGO	REF.	
4042	nº 16	200

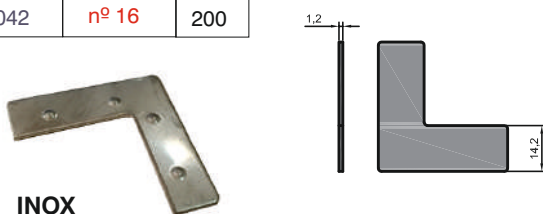

INOX

## Escuadra de alineación V94. 5 x 1,6

CODIGO	REF.	
1636	5x1,6	500

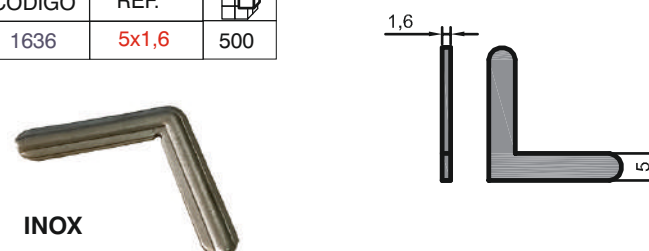

INOX

## Escuadra alineación. 9,8 x 1,5

CODIGO	REF.	
1643		500

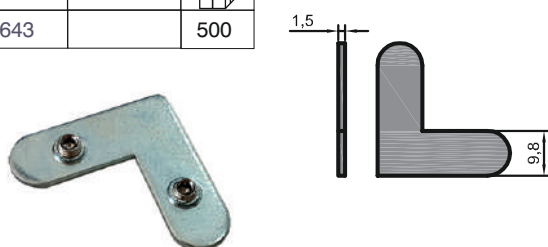

## Escuadra alineación. 4,8 x 0,8

CODIGO	REF.	
1635	2005010	500

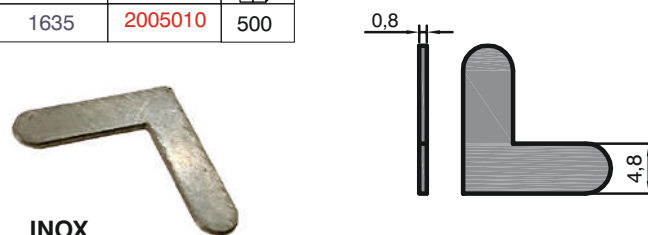

INOX

NOTA: Para otros modelos consultar con Dpto. Comercial.

## Escuadra de alineación con 4 esparragos 6 x 6

CODIGO	REF.	
8756	NI4050.1	500



INOX

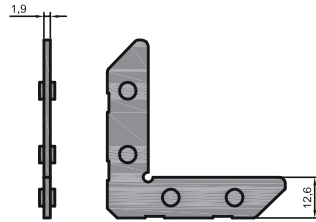

## Escuadra de alineación con esparrago 6 x 6

CODIGO	REF.	
6085		500



INOX

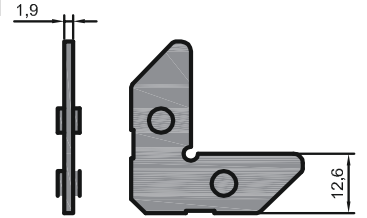

## Escuadra de alineación 9,6 x 0,8

CODIGO	REF.	
13606	2686611	500



INOX

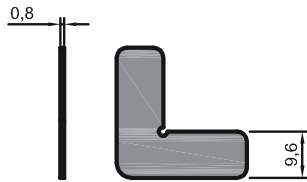

## Escuadra de alineación. 11,9 X 1

CODIGO	REF.	
17746		500



INOX

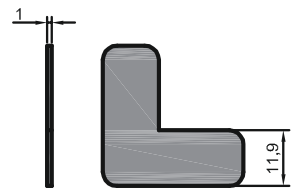

## Escuadra de alineación 7 x 1

CODIGO	REF.	
15211	2686611	500

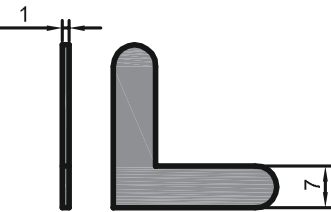

## Escuadra de alineación 4,5 x 0,5

CODIGO	REF.	
1632	3901628	500



INOX

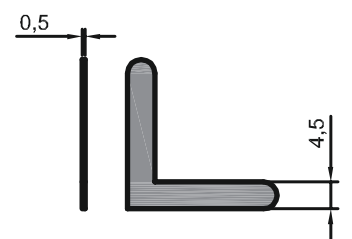

11

## Escuadra alineación forro 12 x 3,7

CODIGO	REF.	
23386	6-26123	250

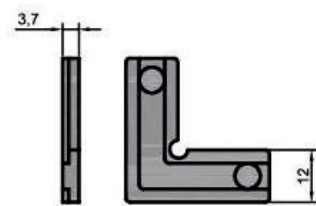

## Escuadra de alineación con dos tornillos

CODIGO	REF.	
9847	----	200

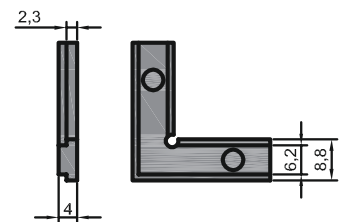

## Escuadra alineación 15 x 0,8

CODIGO	REF.	
4459	19215008V	500



INOX

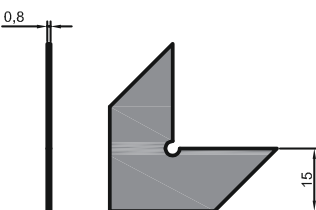

## Escuadra alineación 15 x 1,2

CODIGO	REF.	
4458	18001860	500



INOX

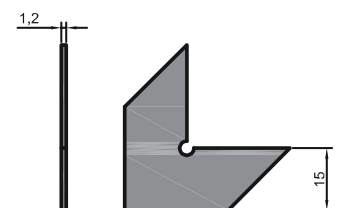

## Pie de barandilla de zamac, para tubo 30x30

CÓDIGO	REF.	COLOR	
2960	815	CRUDO	100
2958	815	BLANCO	100
2959	815	NEGRO	100

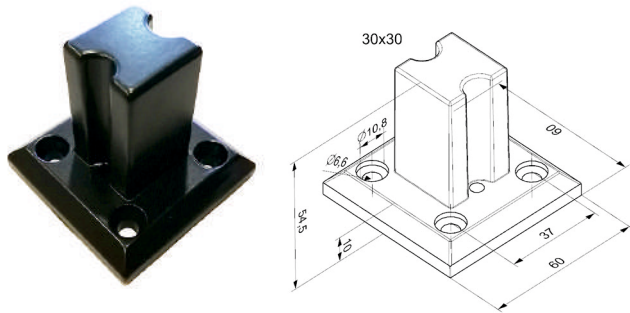

## Pie de barandilla de zamac, para tubo 30x30

www.herrajesuropeos.com

CÓDIGO	REF.	COLOR	
3497	508	BLANCO	100
2956	508	NEGRO	100
2957	508	LAC PLATA	100
4591	508	LAC INOX	100

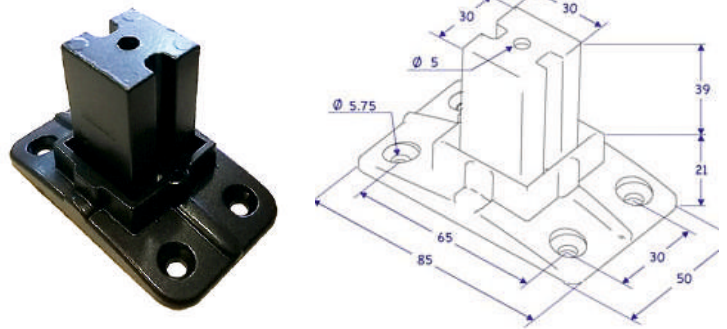

## Embellecedor pie de barandilla de zamac, para tubo 30x30

CÓDIGO	REF.	COLOR	
1368	816	CRUDO	200
1366	816	BLANCO	200
1367	816	NEGRO	200

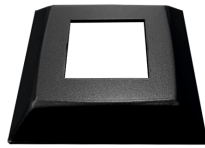

## Pie de barandilla de aluminio para perfiles de 30x30 o 40x40

CÓDIGO	REF.	COLOR	
8526	----	BLANCO	48
5468	----	NEGRO	48
11464	----	LAC PLATA	50
13359	----	LAC INOX	50

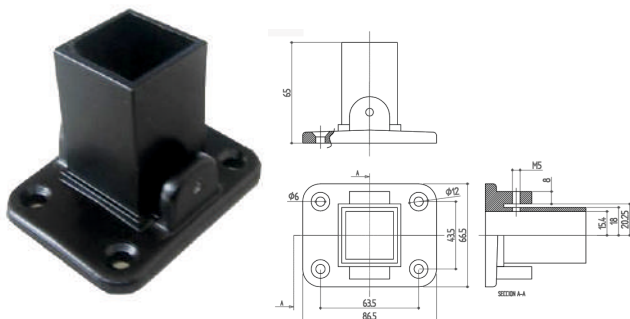

## Soporte de aluminio 30 x 30

CÓDIGO	REF.	COLOR	
6008	5082	Blanco	50
7010	5082	Negro	50
8700	5082	Lac plata	1
13618	5082	Lac inox	1

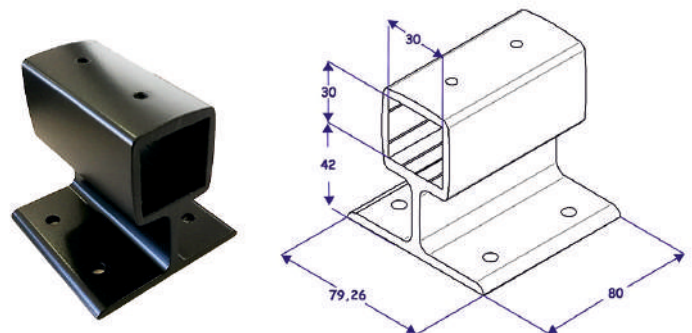

## Pie de barandilla de aluminio, para tubo 40x20

CÓDIGO	REF.	COLOR	
8778	008	BLANCO	20
9338	008	NEGRO	20
17356	008	LAC PLATA	20
17865	008	LAC INOX	20

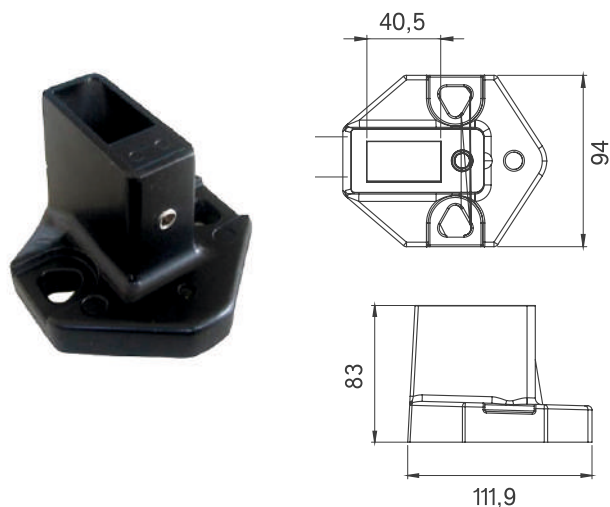

## Soporte de aluminio 40x20

CÓDIGO	REF.	COLOR	
5631	5081	Blanco	30
6800	5081	Negro	30
16182	5081	Lac plata	1
20844	5081	Lac inox	1

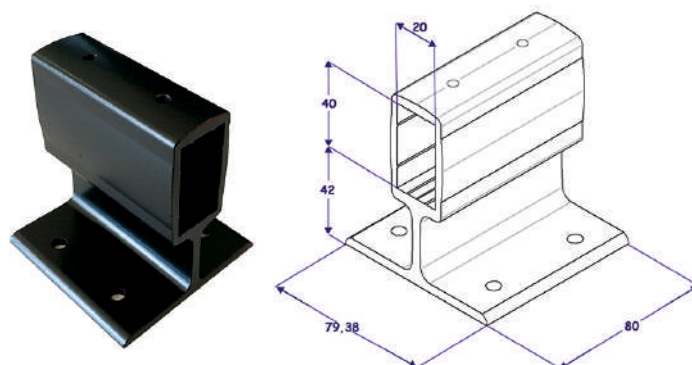

## Soporte fijo de aluminio para cristal y tubo 40X20 (posibilidad de acabado anodizado)

CÓDIGO	REF.	COLOR	
11043	5120	Blanco	1
11615	5120	Negro	1
11614	5120	Lac plata	1
20237	5120	Lac inox	1

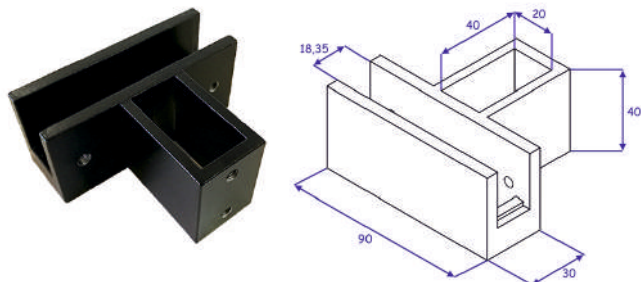

## Cuña de nylon para soporte 5120

CÓDIGO	REF.	CRISTAL	
23749	5120	crystal 4 + 4	1
23750	5120	crystal 6 + 6	1

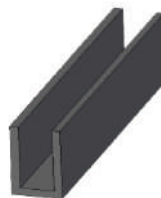

## Soporte pasamanos de aluminio (posibilidad de acabados anodizados)

CÓDIGO	REF.	COLOR	
5920	SOP	Blanco	12
6329	SOP	Negro	12
7823	SOP	Lac Plata	1
16953	SOP	Lac Inox	1

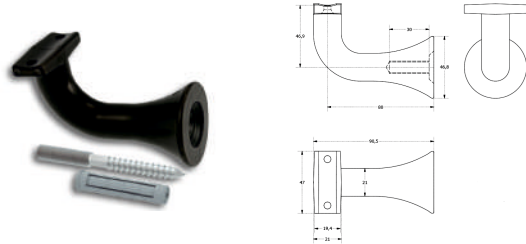

## Fijabarandillas de aluminio a pared

CÓDIGO	REF.	COLOR	
6476	5091	Blanco	100
7011	5091	Negro	100

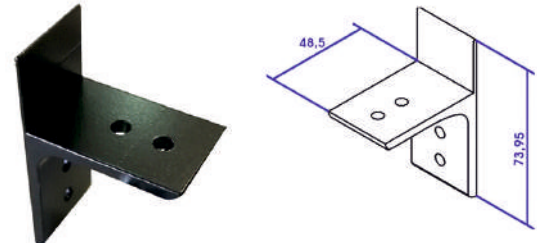

## Pinza de aluminio para vidrio

CÓDIGO	REF.	COLOR	
4552	511	Blanco	50
6477	511	Negro	50
4987	511	Anod plata	1
7328	511	Lac inox	1

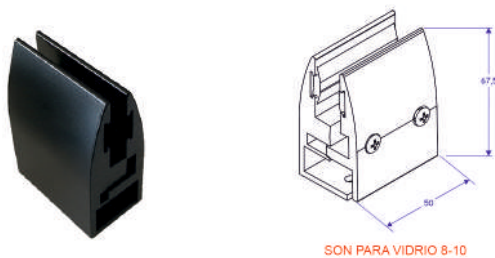

## Anclaje a pared para U

CÓDIGO	U	
20444	40X20	1
20521	51X21	1

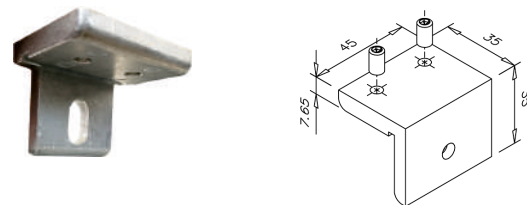

## Remate de aluminio para pasamanos

CÓDIGO	REF.	COLOR	A	B	
4041	514	Blanco	18	45	1
4434	514	Negro			1
19236	515	Blanco	22	50	1
15191	515	Negro			1



## Remate de aluminio para pasamanos

CÓDIGO	REF.	COLOR	MEDIDA	
4201	514R	Blanco	O60	1
4341	514R	Negro	U52	1
9149	515R	Blanco	O60	1
9533	515R	Negro	U56	1

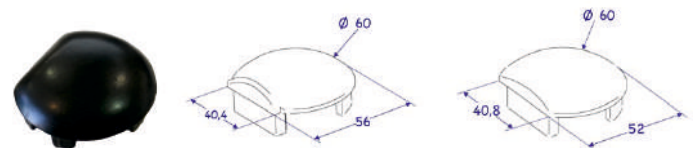

## Escuadra fija barandilla 90°

CÓDIGO	REF.	U	
1624	506	40x20	100
17678	EFAU51	51x21	1

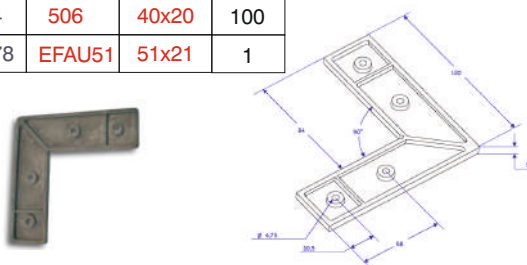

## Escuadra barandilla regulable

CÓDIGO	REF.	U	
1625	507	40x20	100
23403	B45	51x21	1

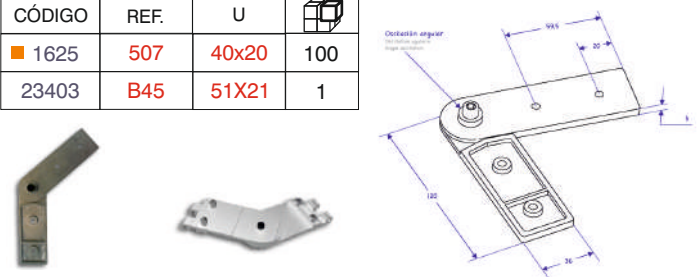



## Sistema de barandilla de vidrio con perfil base de aluminio:

### - PERFILES:

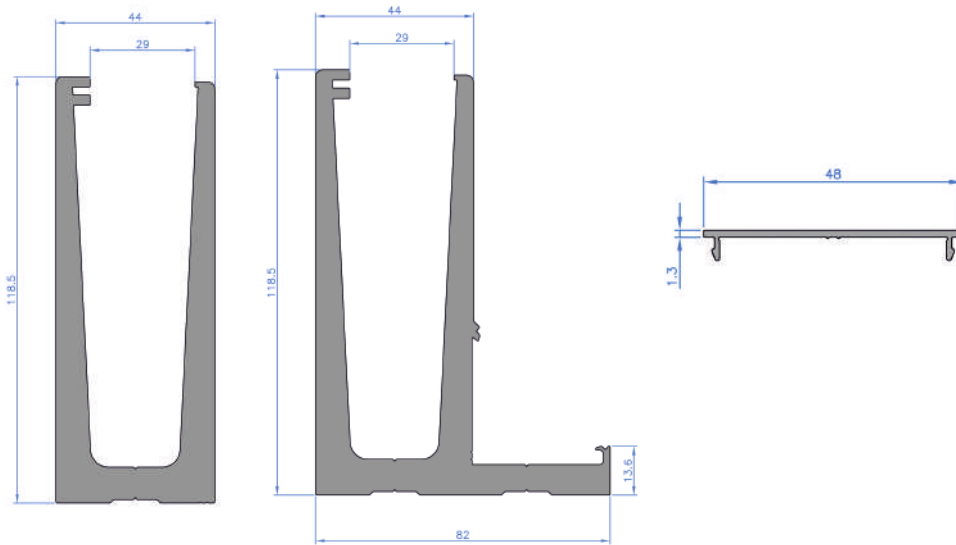

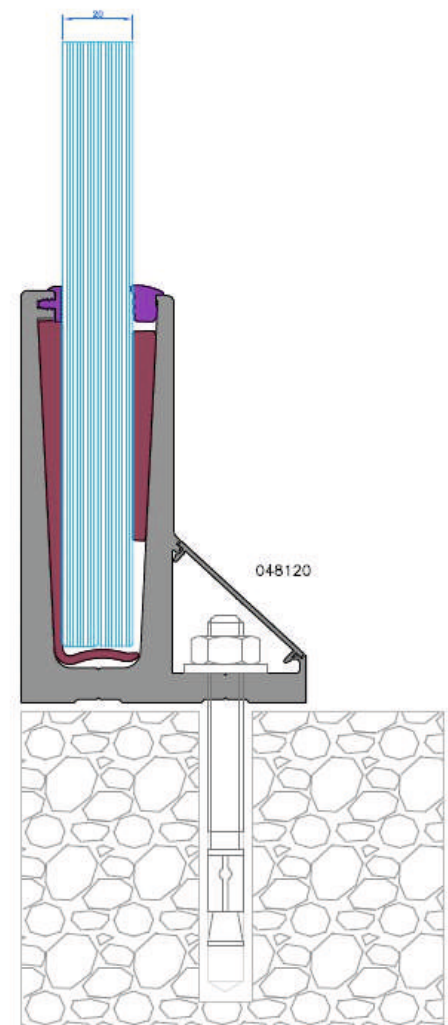

### - SECCIÓN:



### - ACCESORIOS:

#### Inyectadas barandilla (juego cuñas)

CÓDIGO	DESCRIPCION	
14741	Cuña vidrio 8 + 8	400
11166	Cuña vidrio 10 + 10	400

CÓDIGO	DESCRIPCION	
■ 19969	Cuña vidrio 6 + 6	500
■ 19970	Soporte 6 + 6	500

**NOTA:** Es necesario pedir las dos piezas.

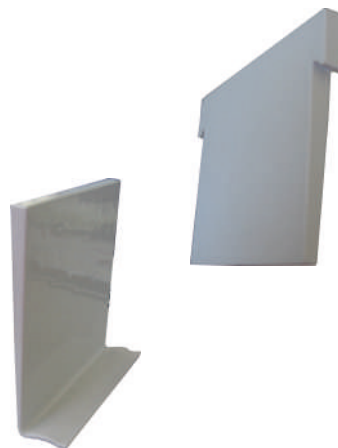

#### Gomas barandilla

CÓDIGO	DESCRIPCION	
11347	Goma T	100
11346	Goma vidrio 10 + 10	100
2234	Goma acristalar para vidrio 8+8	100









## DATOS TÉCNICOS:

	MEDIDAS MAX ALTO	MEDIDAS MAX ANCHO	PESO
Hoja con vidrio de 6mm	3000mm	840mm	40 kgs
	2740mm	900mm	
Hoja con vidrio de 8mm	3000mm	775mm	50 kgs
	2570mm	900mm	
Hoja con vidrio de 10mm	3000mm	740mm	60 kgs
	2470mm	900mm	
Hoja con vidrio de 12mm	3000mm	725mm	70 kgs
	2400mm	900mm	

Nº bisagras intermedias	
De 2100mm a 2200mm alto	2 uds
De 2200mm a 2600mm alto	3 uds
De 2600mm a 3000 mm alto	4 uds

## PERFILES:

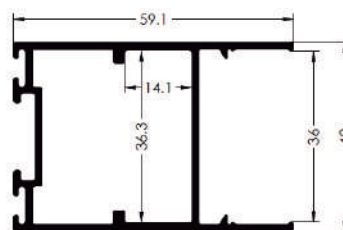

Ref.1689  
Hoja  
Mallorquinas

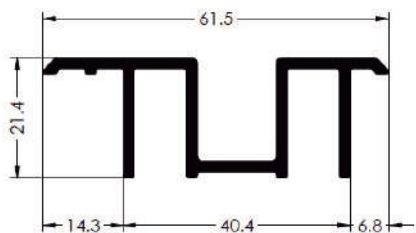

Ref.1685  
Guía Inferior Empotrar

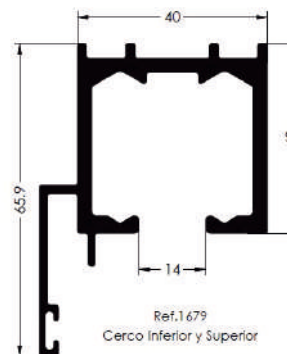

Ref.1679  
Cercos Inferior y Superior

## Juego bisagras superior e inferior

CODIGO	REF.	COLOR	
11928	30R01	Blanco	50
11926	30R01	Negro	50

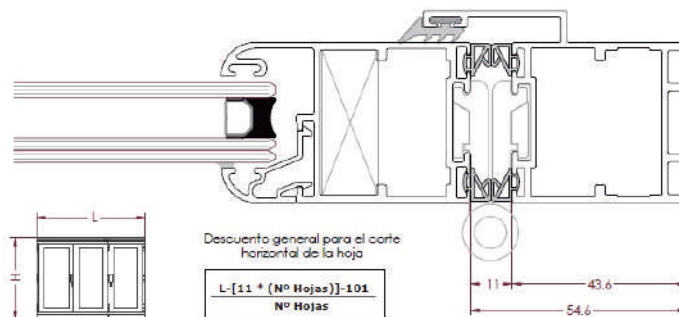
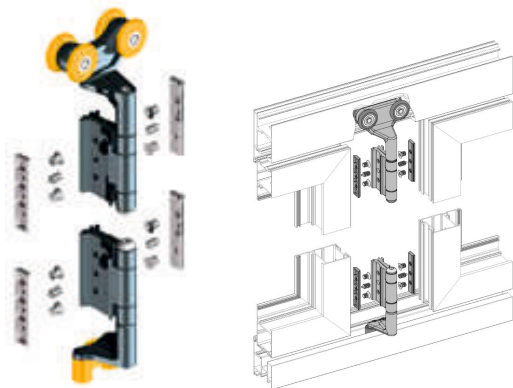

## Bisagra desmontable

CODIGO	REF.	COLOR	
14409	30B06	Blanco	2
14408	30B06	Negro	2

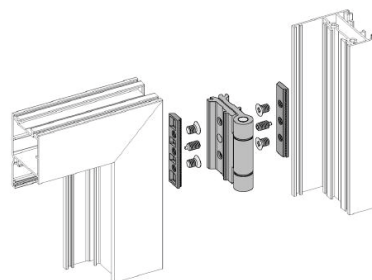

## Bisagra fija

CODIGO	REF.	COLOR	
17638	30B05	Blanco	2
17063	30B05	Negro	2

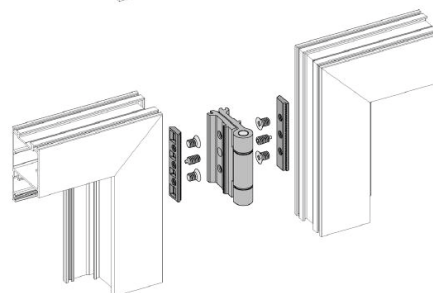

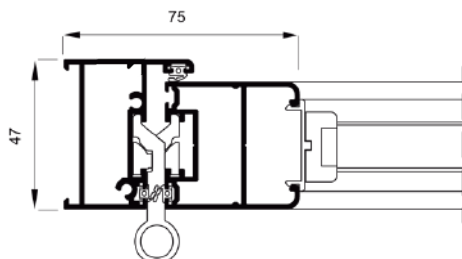

Artículo / Article	H max	L min	L max	Portata max
Art. 9147.4 Cernlera 2 all	1500 mm	550 mm	700 mm	50 Kg per anta
Art. 9147.46 Cernlera 3 all	2500 mm	550 mm	700 mm	60 Kg per anta

## Bisagra normal de dos cuerpos.

CODIGO	REF.	COLOR		
7685	9147.4	Blanco	Alas largas	50
7684	9147.4	Negro		50
11758	9148.4	Blanco	Alas largas	50
11809	9148.4	Negro		50



## Bisagra normal de tres cuerpos.

CODIGO	REF.	COLOR		
7922	9147.46	Blanco	Alas largas	50
7826	9147.46	Negro		50
11866	9148.46	Blanco	Alas largas	50
11867	9148.46	Negro		50



## Bisagra dos cuerpos con asa

CODIGO	REF.	COLOR	
21587	93638.8	Blanco	50
21588	93638.8	Negro	50



## Conjunto carro / bisagra superior.

CODIGO	REF.	COLOR	
7583	93630.5A	Blanco	10
7673	93630.5A	Negro	10



## Conjunto carro / guía inferior para guía embutida.

CODIGO	REF.	COLOR	CANAL	
7584	93630.6A	Blanco	11 mm	10
7674	93630.6A	Negro	11 mm	10



## Plegable 120 kgs. \* Rodamiento de aguja

CODIGO	REF.	COLOR	
16954	bisagra 2 palas	Blanco	1
16955	bisagra 2 palas	Negro	1
16956	conjunto carros sup/inf*	Blanco	1
16957	conjunto carro sup/inf*	Negro	1



## Conjunto carro / guía inferior para guía superpuesta

CODIGO	REF.	COLOR	CANAL	
7923	93630.6B	Blanco	15 mm	10
7924	93630.6B	Negro	15 mm	10



## Tapón mecanizado para carro superior.

CODIGO	REF.	
12739	2337	1

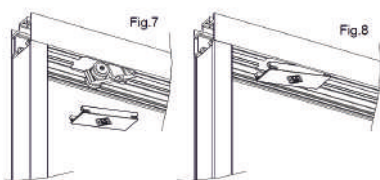
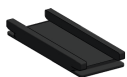

## Carro hojas pares

CODIGO	REF.	
7680	402000000	1



13

## Cremona 6027 plana.

CODIGO	REF.	COLOR	PALAS	
7642	6027.7	Blanco	37 mm	20
7643	6027.7	Negro	37 mm	20
7640	6027.5	Blanco	42 mm	20
7641	6027.5	Negro	42 mm	20
7648	6427.1	Tornillo de 25mm		20
7762	6427.2	Tornillo de 40mm		20



## Cierre doble acción 215

CODIGO	REF.	COLOR	
14967	215	Blanco	10
14968	215	Negro	10

## Pomo para cierre 215

CODIGO	REF.	COLOR	
14971	215-T	Blanco	10
14970	215-T	Negro	10

## Bulones para cierre 215

CODIGO	
14969	10

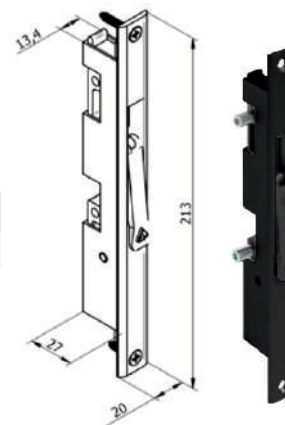

## Goma plegable hoja / marco

CODIGO	REF.	
24788	41868	200





## Carro ruedas corredera. Peso máximo 120 kgs (2 carros)

CODIGO	REF.		
7677	93635.2		60
■ 16367	1420	Alcoa	2

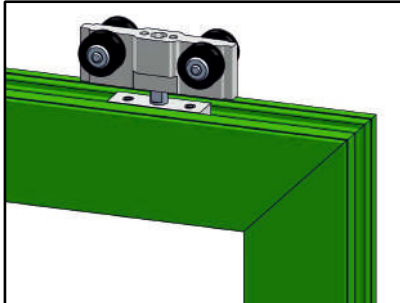
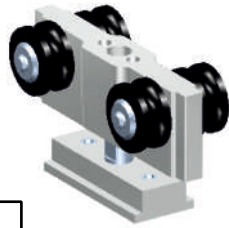

## Pieza retencion hoja corredera.

CODIGO	REF.	
7681	83635.1	50
7678	83635.2	50

Ref.83635.1

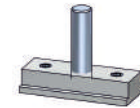
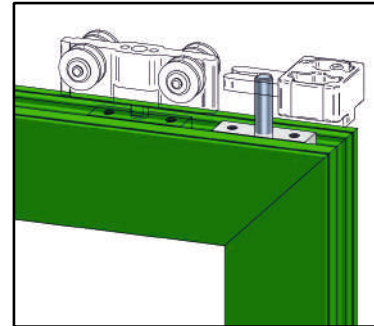
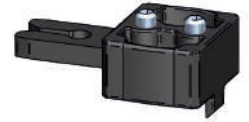

Ref. 83635.2  
**Tope con amortiguación**

CODIGO	REF.	
■ 17080	1430	Alcoa

## Pieza inferior guia hojas corredera.

CODIGO	REF.		
7683	83635.3		50
■ 16471	1425 (14mm)	Alcoa	2

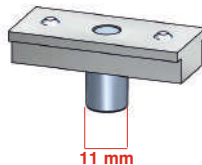

11 mm

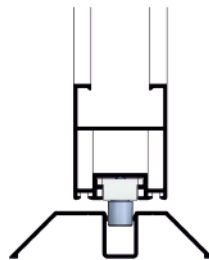
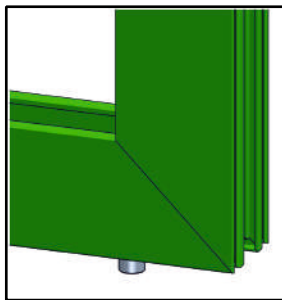

## Kit cerraderos entre hojas correderas.

CODIGO	REF.	
7679	93638.1	50

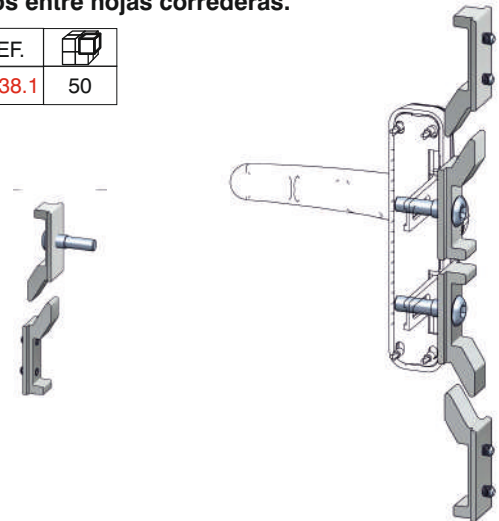

**NOTA:** para una cremona se necesitan dos kits.

## Terminal falleba, cerradero y pasador.

CODIGO	REF.		
7682	A4032.58	200	
7675	93638.2	50	
7676	A4011.50	100	
■ 17082	Kit puntera y cerradero ALCOA		1
■ 17081	Puntera para guia empotrada ALCOA		1



**A4032.58**

terminal falleba, con refuerzo de acero y cabezal regulable



**93638.2**

cerradero mallorquina batiente



**A4011.50**

pasador hoja secundaria con refuerzo de acero y cabezal regulable

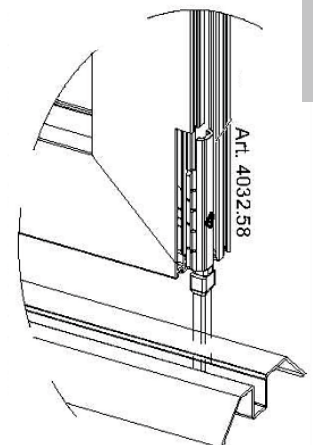
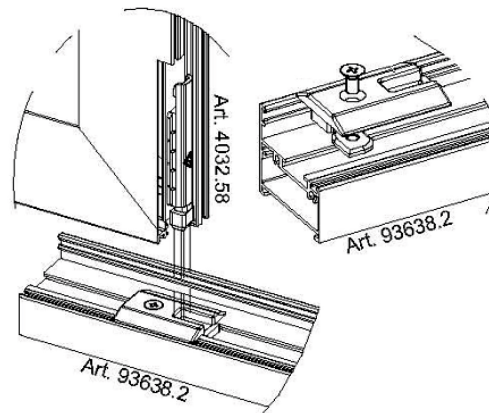



## Aireador TRIMVENT S13

Aireador de plástico y atornillado. Puede instalarse en el cajón de la persiana o en el marco de la ventana. Se puede utilizar en ventanas de PVC, madera y aluminio.

CÓDIGO	REF.	LARGO	COLOR	
5757	TV S13	411 mm	Blanco	100
8283	TV S13	411 mm	Negro	100
5887	TV S13	411 mm	Plata	100



## Rejilla exterior plástico

Rejilla de plástico y atornillada.

CÓDIGO	REF.	LARGO	COLOR	
6320	TV C13	412 mm	Blanco	100
10702	TV C13	412 mm	Negro	100

## Aireador TRIMVENT 90

Aireador de aluminio y embutido. Puede instalarse en el cajón de la persiana o en el marco de la ventana. Se puede utilizar en ventanas de PVC, madera y aluminio.

CÓDIGO	REF.	LARGO	COLOR	
5746	TV 90	300 mm	Blanco	100
5944	TV 90	300 mm	Negro	100
5945	TV 90	300 mm	Anod. plata	100
6532	TV 90	525 mm	Blanco	50
6102	TV 90	525 mm	Negro	50
5936	TV 90	525 mm	Anod. plata	50

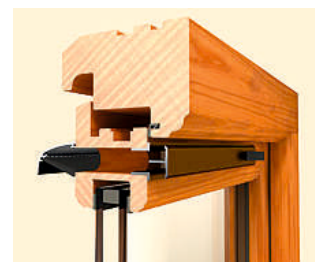

## Rejilla exterior aluminio (dos posiciones)

CÓDIGO	REF.	LARGO	COLOR	
5749	TV SF	318	Blanco	50
6029	TV SF	318	Negro	50
6031	TV SF	318	Lac. Plata	50
5753	TV SF	643	Blanco	50
6534	TV SF	643	Negro	50
5937	TV SF	643	Lac. Plata	50



## Aireador TRIMVENT SF XTRA.

Aireador de aluminio. Aireador en barras de 3 metros. Puede instalarse en el cajón de la persiana o en el marco de la ventana. Se puede utilizar en ventanas de PVC, madera y aluminio.

CÓDIGO	REF.	LARGO	COLOR	
17412	TV SF XTRA	3 mts	Blanco	60 mts
17521	TV SF XTRA	3 mts	Negro	
17428	TV SF XTRA	3 mts	Crudo	
17370	KIT SF XTRA	-----	Blanco	
17432	KIT SF XTRA	-----	Negro	



## Rejilla exterior aluminio

Rejilla de aluminio con dos posiciones.

CÓDIGO	REF.	LARGO	COLOR	
5822	TV SF	3 mts	Blanco	60 mts
6318	TV SF	3 mts	Negro	
5948	TV SF	3 mts	Crudo	
5821	KIT SF	-----	Blanco	
5949	KIT SF	-----	Negro	

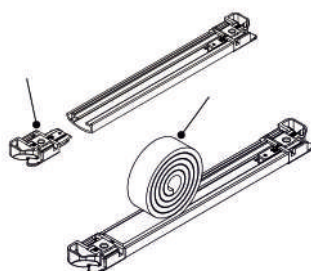

CÓDIGO	REF.	LARGO
17371	GOMA SF XTRA	25 mts



## Aireador TRIMVENT TH

CÓDIGO	REF.	LARGO	COLOR
6405	Th278-020	275 mm	Blanco
5741	Th278-026	275 mm	Negro
■ 8369	Th31-020	505 mm	Blanco
■ 6519	Th31-026	505 mm	Negro

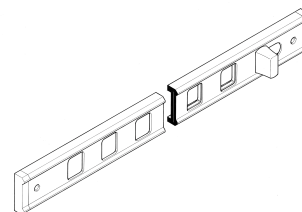

## Aireador autoregulable M-G

Entrada de aire fabricada en poliestireno de alto impacto. Garantiza la renovación del aire en una vivienda a través de las estancias principales. Permite obtener un caudal entre 15 y 45 m<sup>3</sup>/h.

CÓDIGO	REF.	MEDIDAS	COLOR
■ 15379	M-G 45	405 x 20 x 18	Blanco
■ 13696	M-G 45	405 x 20 x 18	Negro



## Aireador autoregulable ISOLA 2 y Aireador Higroregulable ISOLA HY

CÓDIGO	REF.	LARGO	COLOR
■ 7386	ISOLA 2	422 mm	Blanco
■ 7388	ISOLA 2	422 mm	Negro
■ 7374	ISOLA HY	420 mm	Blanco
■ 7663	ISOLA HY	420 mm	Negro



## Aireador CASETE S

CÓDIGO	REF.	MEDIDAS	COLOR
■ 20431	CASETE S	400 X 26 X 27	Blanco
■ 14522	CASETE S	400 X 26 X 27	Negro

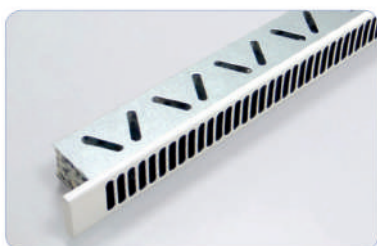

## Aireador AIRSLOT 45.

CÓDIGO	REF.	MEDIDAS	COLOR
■ 9044	AIRSLOT 45	624 X 16 X 45	Blanco
■ 9805	AIRSLOT 45	624 X 16 X 45	Negro



## Aireador SWING UP.

Aireador de aluminio. Se instala en la parte superior del vidrio. Se sirve en barras de 3 metros. No necesita rellija exterior. Disponible para vidrios de 20-22mm y 24-28mm.

CÓDIGO	REF.	LARGO	COLOR
5772	SWING UP 24-28	3 mts	Blanco
4996	SWING UP 24-28	3 mts	Negro
4805	SWING UP 24-28	3 mts	Plata
■ 5443	SWING UP 24-28	3 mts	Crudo
4806	KIT SWING UP L	-----	Negro



**NOTA:** Disponemos de un catalogo específico de aireadores.

## Sistema de sellado para ventanas:

El principio de estanqueidad y aislamiento de juntas entre carpintería y obra se basa en tres niveles de sellado y aislamiento

### SELLADO EFICIENTE DE 3 NIVELES:

#### NIVEL 1: Separación del clima interior y exterior. (Hermeticidad / barrera de vapor)

En este nivel se evita la penetración de aire húmedo en la estructura, evitando las condensaciones en las zonas donde las temperaturas superficiales están por debajo del punto de rocío. Los productos de sellado estanco evitan las pérdidas incontroladas de calor y las corrientes de aire húmedo no deseadas a través de las juntas de conexión.

#### NIVEL 2: Área funcional, aislamiento térmico y acústico (Material flexible)

En este nivel se garantiza la protección térmica y acústica. El área funcional debe permanecer seca y sin riesgo de que se forme condensación ni dentro ni fuera de la habitación a causa de la lluvia. Un 5% de humedad puede reducir el aislamiento hasta un 50%

#### NIVEL 3: Protección segura contra la intemperie. (Sellado exterior)

Este sellado proporciona resistencia a la lluvia torrencial y actúa de barrera contra el viento y la lluvia. Para las cintas expansivas de sellado, el valor de impermeabilidad al agua, debe ser al menos de 600 Pa-BG1.

Estos 3 niveles se consiguen mediante la combinación de productos o utilizando productos multifunción.

**SELLADO EXTERIOR**  
Estanqueidad al agua 1.000Pa.  
<La capa de sellado exterior debe de ser impermeable y resistente a la intemperie>.



**SELLADO INTERIOR**  
Hermeticidad al aire  
( $\alpha=0,00 \text{ m}^3$ ).  
<Resistente al vapor de agua. La capa de sellado interior debe de ser estanca>.

**AISLAMIENTO**  
Aislamiento térmico desde  $U=0,8$ ,  
y acústico desde 45dB.  
<La unión entre la carpintería y la obra se debe aislar con material flexible térmico y acústico>.

## UNE 85219:16

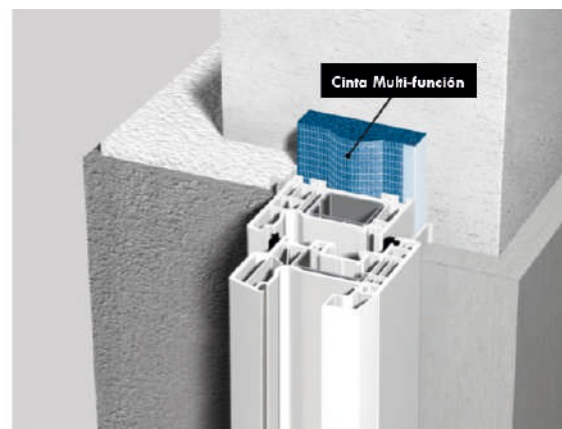
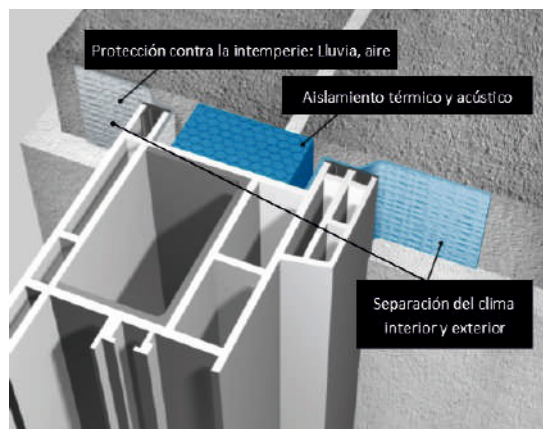

## Cinta expansiva multifunción ISO-BLOCO ONE

CODIGO	ANCHO DE CINTA / AREA DE APLICACIÓN	ANCHO PERFIL	ROLLO	CAJA
19251	40/2-10	50	30	270
18391	54/2-10	60	30	210
18403	64/2-10	70	30	180
■ 20729	74/2-10	80	30	150
■ 19791	54/2-12	60	30	210
■ -----	64/2-12	70	30	180
■ ----	74/2-12	80	30	150
■ 20730	82/2-12	90	30	120
■ 20591	92/2-12	--	--	----
■ 20590	162/2-12	--	--	---
20589	40/3-15	---	---	----
19923	54/3-15	60	20	140
■ 20679	64/3-15	70	20	120
■ 21962	74/3-15	80	20	100
■ -----	54/3-18	60	20	140
18791	64/3-18	70	20	120
■ -----	74/3-18	80	20	100
■ 24242	82/3-18	90	20	80
■ 21919	54/5-30	60	12	84
■ -----	64/6-30	70	12	72
■ -----	74/6-30	80	12	60
■ -----	82/5-30	80	12	48

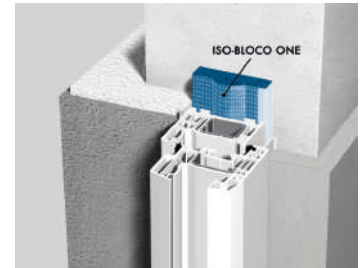

MEDIDA MINIMA: 40mm  
MEDIDA MAXIMA: 300mm

EXPANSIÓN MINIMA: 2 - 10mm  
EXPANSIÓN MAXIMA: 5 - 30mm

Escanee el código para ver el video de instalación 1:



Escanee el código para ver el video de instalación 2:



### UTILIZACIÓN:

- Para el sellado optimo de las juntas que existen entre las ventanas o puertas y el premarco o muro.

### CARACTERÍSTICAS:

- Cinta con altísima funcionalidad, compuesta por espuma poliuretánica de celdas abiertas, impregnada con resina sintética.
- Elevada capacidad de expansión.
- **Garantiza el cumplimiento de las 3 barreras:** la parte externa nos garantiza la estanqueidad al agua con la acción del viento hasta 1000Pa, en la parte intermedia el aislamiento térmico y acústico y en la parte interna una absoluta impermeabilidad al aire con barrera al vapor de agua.

### VENTAJAS:

- Tres productos en uno.
- Fácil y rápido de aplicar.
- Contribuye a reducir las pérdidas de calor por convección.
- Facilita la difusión del vapor hacia el exterior, garantizando una junta siempre seca.

Datos técnicos	Norma	Clasificación
Impermeable a la lluvia torrencial, una sola junta	DIN EN 1027	≥ 1.000 Pa
Coefficiente de permeabilidad al aire	DIN EN 12114	a = 0,00m3/(h·m·(daPa)n)
Valor U: profundidad de construcción de la ventana 60 mm / 70 mm / 80mm	DIN 4108-3	U= 0,8W / (m2·K) 0,70 W / (m2·K) / 0,6 W / (m2·K)
Aislamiento acústico		56 dB en junta de 10mm



## Cinta expansiva ISO-BLOCO MULTI-FUNCTIONAL TAPE

CODIGO	ANCHO DE CINTA / AREA DE APLICACIÓN	ROLLO	CAJA
18535	30/5-10	5,6	56
18971	30/7-15	4,3	43
■ 18925	30/10-20	3,3	33
■ 20212	54/7-15	4,3	21,5
■ 23875	74/5-10	5,6	22,4



**MEDIDA MINIMA: 30mm**  
**MEDIDA MAXIMA: 84mm**

**EXPANSIÓN MINIMA: 5 - 10mm**  
**EXPANSIÓN MAXIMA: 10 - 20mm**

La ISO BLOCO MULTI-FUNCTIONAL TAPE es una cinta de sellado especial de juntas de aplicación multi funcional y excelentes prestaciones. Sella las juntas de unión de ventanas y puertas al aire y la lluvia torrencial, a la vez que ofrece propiedades de aislamiento térmico en toda la profundidad de la junta.

Posee las propiedades de sellado que permite la difusión del vapor conforme al principio RAL, lo que garantiza el perfecto secado de la junta.

### APLICACIÓN

La ISO BLOCO MULTI-FUNCTIONAL TAPE es una cinta polivalente que unifica en un solo producto todas las exigencias de instalación. Resulta especialmente indicado para un sellado seguro, sencillo y rápido de uniones de ventanas y puertas.

### VENTAJAS:

- Sellado de 3 niveles en un solo producto.
- Sellado rápido y fiable de las ventanas con una instalación en un solo paso.
- Gran ahorro de costes al reducir el tiempo de instalación
- Instalación en cualquier condición climática.



Datos técnicos	Norma	Clasificación
Impermeable a la lluvia torrencial, una sola junta	DIN EN 1027	$\geq 600$ Pa
Coefficiente de permeabilidad al aire	DIN EN 12114	$a \leq 0,1 \text{ m}^3 / (\text{h} \cdot \text{m} \cdot (\text{daPa}) \cdot \text{n})$
Valor U: profundidad de construcción de la ventana 60 mm / 70 mm / 80mm	DIN 4108-3	$U = 0,8 \text{ W} / (\text{m}^2 \cdot \text{K})$ / $0,70 \text{ W} / (\text{m}^2 \cdot \text{K})$ / $0,6 \text{ W} / (\text{m}^2 \cdot \text{K})$
Conductividad térmica		$\lambda = 0,048 \text{ W} / \text{m} \cdot \text{K}$

## Cinta multifunción ISO-BLOCO HYBRATEC

CODIGO	ANCHO DE CINTA / AREA DE APLICACIÓN	ROLLO	CAJA
■ 24604	40/3-14	30	300
■ 23406	40/6-40	10	100



**MEDIDA MINIMA: 30mm**  
**MEDIDA MAXIMA: 105mm**

**EXPANSIÓN MINIMA: 3 - 14mm**  
**EXPANSIÓN MAXIMA: 6 - 40mm**

La ISO BLOCO HYBRATEC es una cinta multifunción 4.0 equipada con tecnología híbrida.

### APLICACIÓN

ISO BLOCO HYBRATEC es la cinta multifunción que cumple al 100% con los requisitos de edificios en cuanto a eficiencia energética y fiabilidad. Ofrece una hermeticidad absoluta y el máximo aislamiento térmico, ambos estipulados con carácter obligatorio para casas pasivas y edificios de energía cero, así como una elevada hermeticidad contra la lluvia torrencial adaptada a las variaciones climatológicas y la capacidad de alta absorción de movimiento continuo a largo plazo.

### VENTAJAS:

- Tecnología híbrida mediante capas de láminas
- Absolutamente hermética gracias a varias capas de bloqueo

Datos técnicos	Norma	Clasificación
Impermeable a la lluvia torrencial, una sola junta	DIN EN 1027	$\geq 1.050$ Pa
Coefficiente de permeabilidad al aire	DIN EN 12114	$a = 0,00 \text{ m}^3 / (\text{h} \cdot \text{m} \cdot (\text{daPa}) \cdot \text{n})$
Valor U: profundidad de construcción de la ventana 60 mm / 70 mm / 80mm	DIN 4108-3	$U = 0,8 \text{ W} / (\text{m}^2 \cdot \text{K})$ / $0,70 \text{ W} / (\text{m}^2 \cdot \text{K})$ / $0,6 \text{ W} / (\text{m}^2 \cdot \text{K})$
Aislamiento acústico		Hasta 60dB





Ejemplos de instalación:

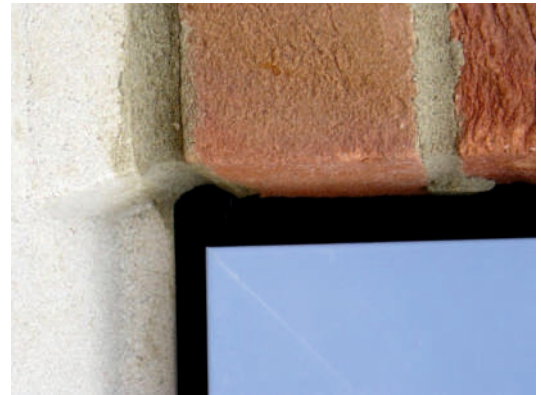
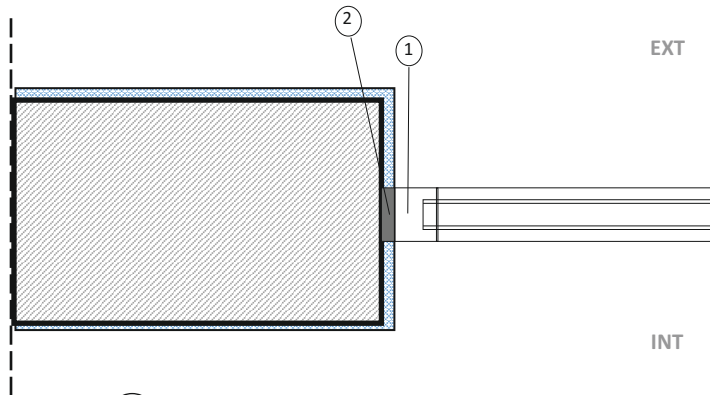

1 Cerco

2 ISO BLOCO ONE  
ISO BLOCO MULTI-FUNCTIONAL TAPE  
ISO- BLOCO HYBRATEC

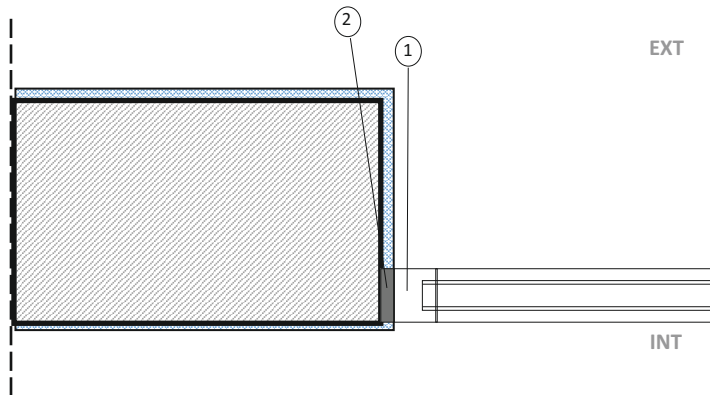

**Sellador ISO TOP FLEX ADHESIVE PA**  
(potente adhesivo / sellador)

CODIGO	TUBO
20771	310ml



ISO-TOP FLEX ADHESIVE está especialmente concebido para garantizar la continuidad de la hermeticidad entre láminas y muros. Muy recomendable para sellar las 4 esquinas en la instalación de carpintería con cintas expansivas. De esta forma reforzamos y garantizamos el sellado hermético en los puntos críticos de la instalación.

Compatible con:

- ISO BLOCO ONE
- HIBRATEC
- ISO CONNECT VARIO SD
- ISO MULTIFUNCTIONAL TAPE
- ISO BLOCO 600



## Cinta multifunción para el compacto ISO BLOCO 600

CODIGO	ANCHO DE CINTA / AREA DE APLICACIÓN	ROLLO	CAJA
19252	15/4-9	20R x 8M	160 M
19393	15/1-4	20R X 13M	260 M
■ 21128	15/6-15	20R x 4,3M	86 M
■ 20731	20/6-15	15R X 4,3M	64,5 M
■ 21545	20/9-20	15R x 3,3M	49,5 M
■ 13866	30/2-6	10R X 12M	120 M



ISO-BLOCO 600 ha sido concebida especialmente para el perfecto sellado de juntas en edificios y fachadas de hasta 100m de altura. Junto a una resistencia a la lluvia torrencial de más de 600 Pa, ISO BLOCO 600 posee además excelentes propiedades de aislamiento térmico y acústico.

### APLICACIONES:

Muros cortina, tapajuntas, encuentros y sellados contra muros.

### CARACTERÍSTICAS

Aisla contra la lluvia torrencial, viento y polvo  
Resiste la exposición a los rayos del sol

Datos técnicos	Norma	Clasificación
Impermeable a la lluvia torrencial, una sola junta	DIN EN 1027	$\geq 600$ Pa
Coefficiente de permeabilidad al aire	DIN EN 12114	$a \leq 1,0m3/(h \cdot m \cdot (daPa)n)$ controlado externamente por ift
Valor sd	DIN EN ISO 12572108-3	$U = 0,8W / (m^2 \cdot K) / 0,70 W / (m^2 \cdot K) / 0,6 W / (m^2 \cdot K)$
Clase de material de construcción		B1 (resistente al fuego)



## Cinta multifunción ISO CONECT VARIO SD tipo C

(1 tira auto-adhesiva en la cara lanosa + 1 tira de butilo en cara plástica en lados opuestos)

CODIGO	ANCHO PERFIL	ROLLO	CAJA
19253	70	30	120
■ 21862	90	30	90

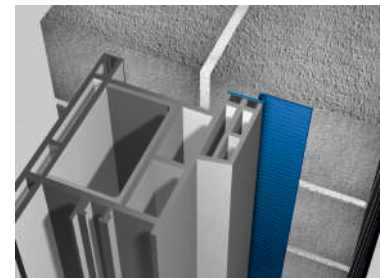

La lámina de unión innovadora para ventanas se adapta a los diferentes cambios de temperatura de cada estación del año y la transmisión de la humedad hacia el exterior y hacia el interior. ISO-CONNECT VARIO SD pertenece a una generación completamente nueva de láminas que garantizan que las juntas permanezcan secas durante todo el año, impidiendo la formación de moho en la junta de conexión y sellando la junta.

Cinta ideal para instalar en la parte de interior y exterior de la junta

Datos técnicos	Norma	Clasificación
Impermeable a la lluvia torrencial, una sola junta	DIN EN 1027	$\geq 1.050$ Pa
Coefficiente de permeabilidad al aire	DIN EN 1026	$a = 0 m3/(h \cdot m \cdot (daPa)n)$
Valor sd (permeabilidad a la difusión del vapor)	DIN EN ISO 12572	valor sd en función de la humedad media del aire entre 0.03 m (permeable al vapor) y 15m (barrera de vapor)





## ESPUMA ELASTIFLEX

CODIGO		
21875	750ML	12



ELASTIFLEX es una espuma de PUR de alta elasticidad y baja expansión que triplica aproximadamente la elasticidad de las espumas de PUR convencionales en el mercado. Gracias a su alta flexibilidad se reduce notablemente el riesgo de agrietamiento de la espuma en la junta, lo que asegura la conservación del aislamiento térmico y acústico.



## ISO-TOP CLEANEX

CODIGO		
21876	500ML	12



Ha sido desarrollado especialmente para la limpieza interna de pistolas de botes de espuma PUR. También está indicado para la eliminación de impurezas de PUR frescas, aún húmedas y no endurecidas en diversas superficies de metal, plástico y madera. ISO TOP CLEANEX se puede utilizar en pequeñas cantidades como acelerador de expansión para cintas de sellado de juntas precomprimidas e impregnadas. Para ello, la cinta se rocía con ISO-TOP CLEANEX después de su instalación en la junta.

## PISTOLA DOSIFICADORA ISO-TOP GUN EASY

CODIGO	
21877	1



Pistola dosificadora realizada en plástico robusto de alta calidad y con regulador de dosificación grande, para manejo fácil y aplicación de espuma PUR en construcción.

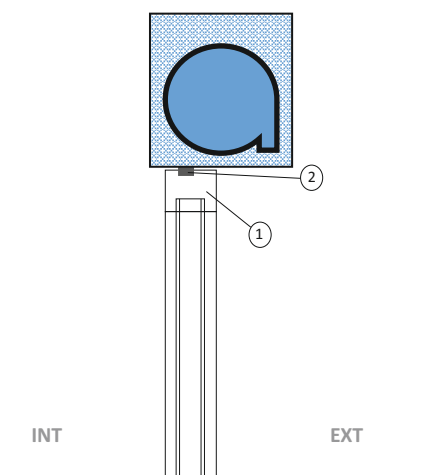

1: Cerco  
2: Iso Bloco 600

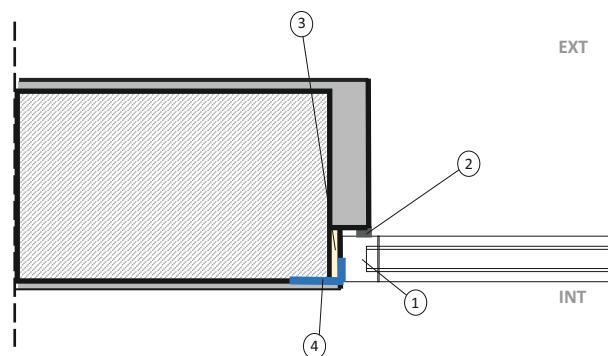

1: Cerco  
2: Iso Bloco 600  
3: Elastiflex  
4: Iso Connect Vario SD

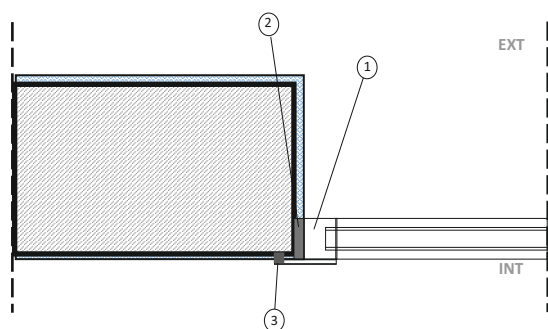

1: Cerco  
2: Elastiflex  
3: Iso Bloco 600

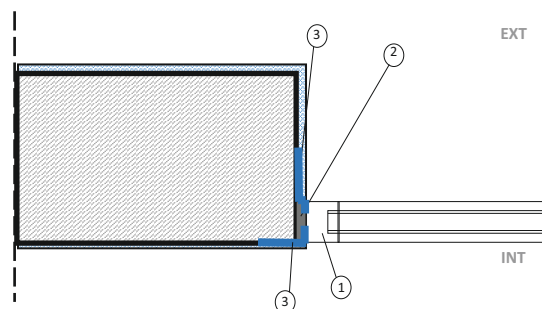

1: Cerco  
2: Elastiflex  
3: Iso connect Vario SD



## PREMARCOS AISLADOS

### Sistema de montaje en la pared ISO-TOP WINFRAMER "TYP 3"

El sistema de montaje en la pared ISO-TOP WINFRAMER "TYP 3" está compuesto de perfiles de aislamiento térmico y con capacidad de carga, realizados en material altamente comprimido THERMAPOR. La excelente conductividad térmica de las piezas moldeadas garantiza su perfecta integración en el Aislamiento de Muros exteriores. De este modo, se optimizan los puentes térmicos y se consigue un alto grado de aislamiento en toda la envolvente del edificio. Previene el riesgo de formación de moho en la zona de unión del perímetro de la abertura de la ventana.

- No absorbe humedad
- Soporta 200 kg/ml



Opción de perfiles estándar con uniones con cola-milano y en paneles de formato 800x1200 mm y diferentes espesores.

Datos técnicos	Norma	Clasificación
Peso volumetrico		150kg/m <sup>3</sup> ± 10%
Coefficiente de permeabilidad al aire	DIN EN 12114	$a \leq 0,00m^3/(h \cdot m \cdot (daPa)n)$
Resistencia al arqueamiento	DIN en 12089	≥ 650 Pa
Conductividad térmica	DIN EN 12667	$\lambda = 0,040W / (m \cdot K)$



- 1: Cerco
- 2: Winframer
- 3: Bloco one / Hybratec / Tape

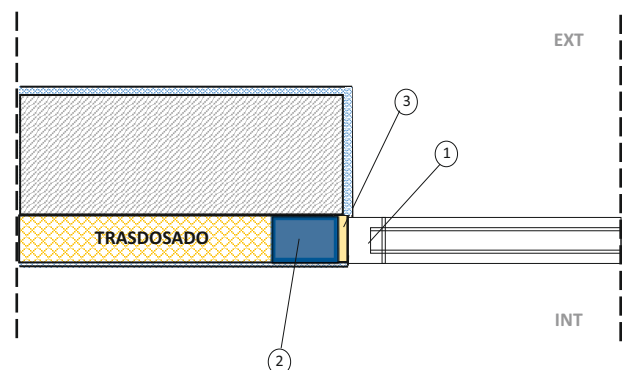
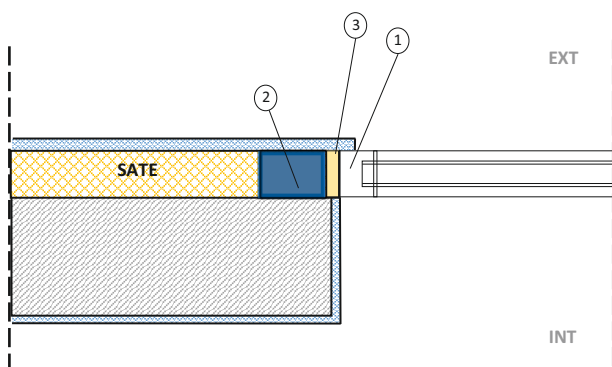

Material sobre pedido, consulta con el departamento comercial



Perfiles división oficina

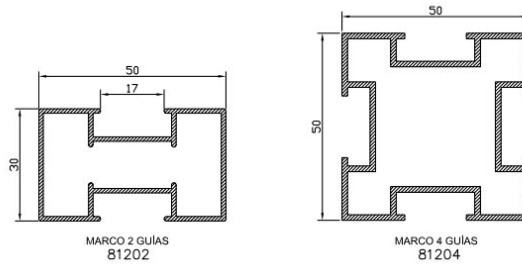

Bisagra para perfiles planos (tubo + tubo)

CODIGO	REF.	COLOR	A	
4470	DIVISORIA	Blanco	105mm	50
4471	DIVISORIA	Negro	105mm	50
6760	DIVISORIA	Plata anod	105mm	50
16610	DIVISORIA	Inox anod	105mm	50
9501	DIVISORIA PUERTA	Blanco	155mm	50
9502	DIVISORIA PUERTA	Negro	155mm	50
11407	DIVISORIA PUERTA	Plata anod	155mm	50

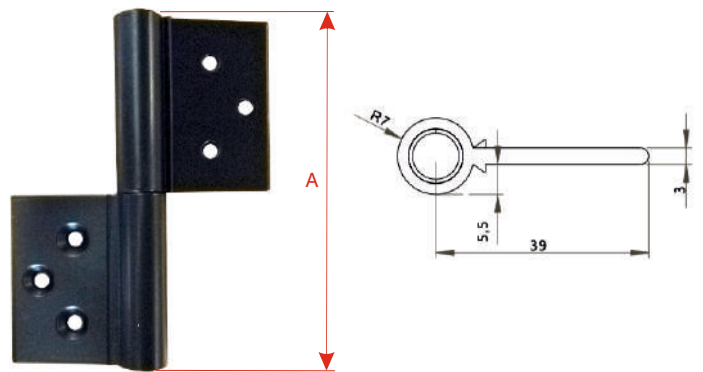

Tensor mobiliario división oficina con tornillo

CODIGO	REF.	
18417	TENSOR	1



Conjunto gomas división oficina para cristal de 6mm

CODIGO	REF.	
5055	c-26 / b-26	100

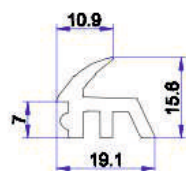

C-23



B-26

## Garras para ventanas o puertas.

CODIGO	REF.	DESCRIPCION	LARGO	ANCHO	ESPESOR	
2059	G.0.1	Garra puerta	125	24	1	1200
■ 2060	G.0.3	Garra puerta	125	24	0,6	1500
2063	G.1.2	Garra ventana	100	20	0,5	2000
■ 2064	G.1.3	Garra ventana	125	20	0,8	1500
■ 7004	G.2.1	Garra reforzada ancho esp.	125	15	1,2	1800
■ 2065	G.2.2	Garra reforzada ancho esp.	125	14	1	2000
2066	G.3.1	Garra ventana larga	170	20	0,8	900
■ 2067	G.3.2	Garra ventana larga	200	20	0,8	900
■ 4227	G.6.1	Garra para portones	200	25	2	500
260	G.7.1	Garra larga esp. puerta	170	24	1	800
2061	G.7.2	Garra larga esp. puerta	200	24	1	750

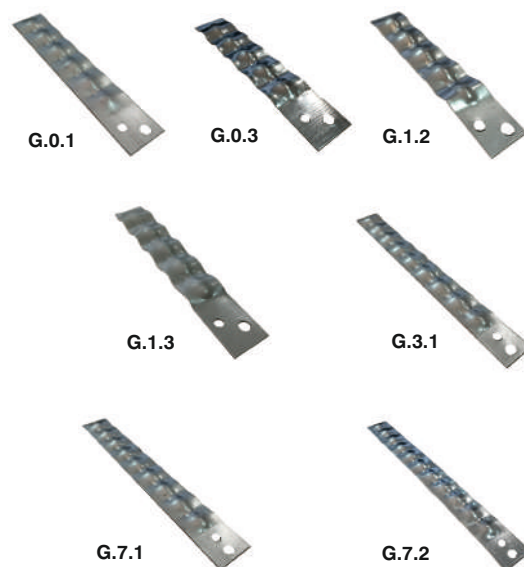

## Cartabón premarco metálico.

CODIGO	REF.	
■ 410	C.235	300



## Cartabón premarco nylon.

CODIGO	REF.	
■ 1649	Es006	200



## Cartabón premarco fijo metálico no recuperable.

CODIGO	REF.	
■ 397	C.19715	500

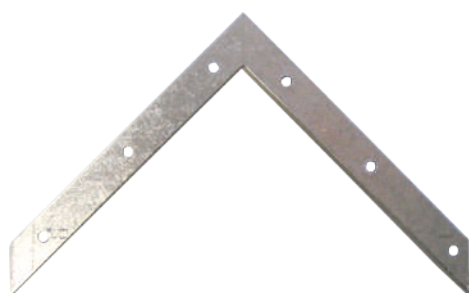

## Cartabón premarco fijo recuperable.

CODIGO	REF.	
412	C.500	25



## Escuadra premarco 24x16 plástico negro.

CODIGO	REF.	
■ 1454	2416	500



## Escuadra premarco 37x12 plástico negro.

CODIGO	REF.	
■ 13465	3712	500



## Escuadra premarco 37x16 plástico negro.

CODIGO	REF.	
■ 1532	3716	400



## Escuadra de premarco

CÓDIGO	REF.	
■ 4063	15-2312	400
13659	15-3712	250

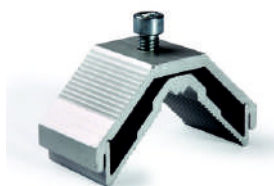

## Escuadra de premarco plástico

CÓDIGO	REF.	
13120	37-2412	200
13465	37-3712	500



## Garra de premarco

CÓDIGO	REF.	
15673	PRE-005	200

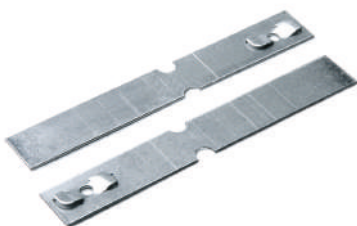

## Cruceta de premarco

CÓDIGO	REF.	MEDIDA	
■ 19099	PRE-006	300mm	125
■ 19103	PRE-007	600mm	250
■ 19105	PRE-008	1000mm	125
■ 19201	PRE-009	1350mm	125

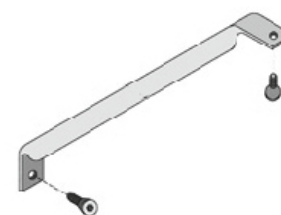

## Pasacinta persiana Aluplaver

CÓDIGO	REF.	
■ 19202	PER-502	72



## Cajetin cinta persiana Aluplaver

CÓDIGO	REF.	
■ 15803	PER-503	48



## Juego soporte reforzado (Balconera)

CÓDIGO	REF.	
■ 15799	PER-501RE	12



## Juego soporte simple (ventana)

CÓDIGO	REF.	
■ 13298	PER-501SI	12



## Soporte

CÓDIGO	REF.	
■ 19204	PER-995	24



## Soporte

CÓDIGO	REF.	
■ 19205	PER-996	24



## Soporte

CÓDIGO	REF.	
■ 19207	PER-997	24



## Soporte

CÓDIGO	REF.	
■ 19208	PER-998	24



## Soporte

CÓDIGO	REF.	
■ 19209	PER-999	24



## Soporte

CÓDIGO	REF.	
■ 19210	PER-501CN	12





## Pletina de falleba para las series de CE.

CODIGO	REF.	ENVASE	MATERIAL	
2965	PFCE	ROLLO	NYLON	125
2964	PFCE	BARRA	NYLON	3
10649	----	ROLLO	POLIAMIDA	200

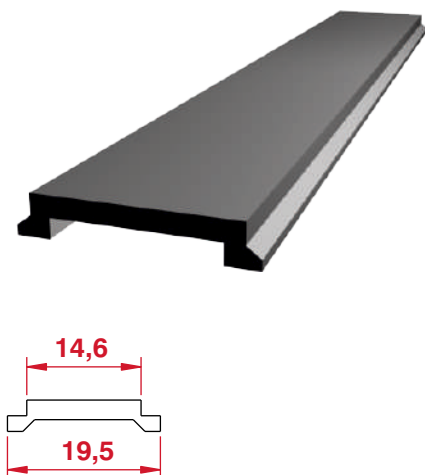

## Pletina de falleba de nylon para las series 6000 y 4000.

CODIGO	REF.	ENVASE		
2966	PF6000	ROLLO	40X20	85
2963	PF6000	BARRA		3
2967	PF4000	ROLLO	40X18	300
2962	PF4000	BARRA		3

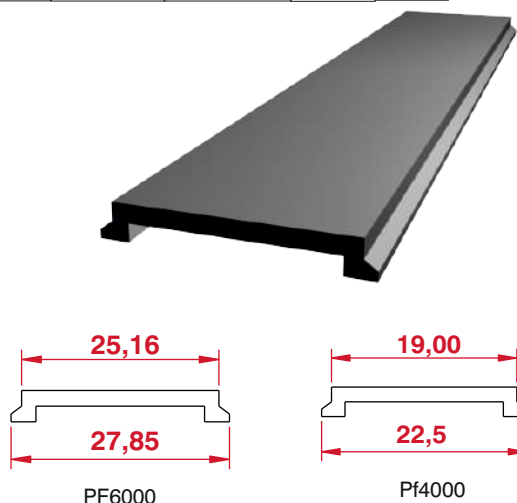

## Tapon zócalo

CODIGO	MEDIDA	COLOR	A	B	
4048	014B	Blanco	14	8,5	500
4049	014N	Negro	14	8,5	500
8997	016B	Blanco	16	10	500
8998	016N	Negro	16	10	500

CODIGO	MEDIDA	COLOR	B	
1079	12mm	Blanco	12	500
3557	12mm	Negro	12	500
460	12mm	Marrón	12	500
3556	12mm	Gris	12	500
459	12mm	Bronce	12	500
456	12mm	Verde	12	500
1080	12mm	ral 1013	12	500



## Tapon rectangular o cuadrado.

CODIGO	MEDIDA	COLOR	
3525	20x20	Blanco	100
3526	20x20	Negro	100
4140	30x30	Blanco	100
3530	30x30	Negro	100
3541	40x40	Blanco	100
3542	40x40	Negro	100
3652	60x60	Negro	50
7452	70x70	Negro	50
5771	70x70	Blanco	50

CODIGO	MEDIDA	COLOR	
3528	30x15	Negro	-
3537	40x20	Blanco	200
3538	40x20	Negro	200
3540	40x30	Negro	200
3543	60x30	Negro	100
3545	60x40	Negro	100
3544	60x40	Blanco	100
7461	70x20	Negro	100
3546	80x20	Blanco	100
3547	80x20	Negro	100



Consultar otras medidas con Dep. Comercial

### Deflector pequeño desagüe carril inferior.

CODIGO	REF.	COLOR	
1138	DPI	Negro	200

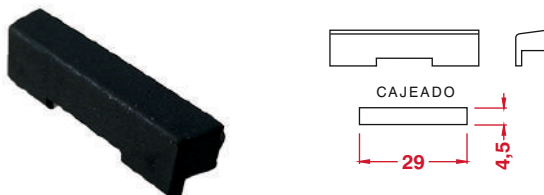

### Deflector pequeño desagüe carril lateral.

CODIGO	REF.	COLOR	
1139	DPL	Blanco	200
1140	DPL	Negro	200



### Deflector IB desagüe carril inferior.

CODIGO	REF.	COLOR	
1129	D-IB	Blanco	150
1130	D-IB	Negro	150



### Deflector TT desagüe carril inferior.

CODIGO	REF.	COLOR	
1141	D-TT	Blanco	150
1142	D-TT	Negro	150



### Deflector desagüe carril inferior.

CODIGO	REF.	COLOR	
1128	D-25	Negro	500

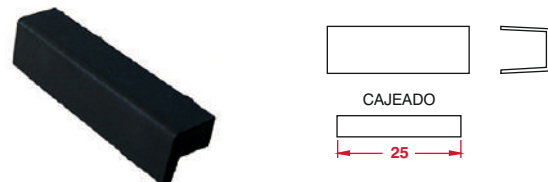

### Válvula de drenaje.

CODIGO	REF.	COLOR	
3809	VD	Blanco	1000
3810	VD	Negro	1000



### Válvula de drenaje con bola.

CODIGO	REF.	COLOR	
5547	18001200	Negro	500



### Tapa perfil inversor de 40x20 y 40x18.

CODIGO	REF.	COLOR	
3536	TI 40X20	Negro	350
3532	TI 40X20 antiguo	Negro	175
3533	TI 40X18	Blanco	350
3534	TI 40X18	Negro	350

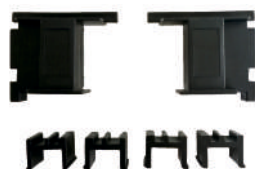

### Tapa perfil inversor V-94 recta.

CODIGO	REF.	COLOR	
20362	TI V94	Negro	400



### Tapa perfil inversor V-94 curvo.

CODIGO	REF.	COLOR	
8380		Negro	350



### Tapa perfil inversor GP40/45 GALISUR

CODIGO	REF.	COLOR	
21831		Negro	400

### Tapa perfil inversor 40x16. (Mallorquina)

CODIGO	REF.	
3564	TI 40X16	200



### Grapa junquillo curvo o recto.

CODIGO	REF.	MODELO	
2281	GJC	Curvo	150
7153	CJR	Recto	150



## Plásticos para calzar el cristal en las ventanas.



CODIGO	ANCHO	ESPESOR	COLOR	Nº TIRAS	CANTIDAD
371	10mm	2mm	BLANCO	4000 tiras	12000 uds
372	10mm	3mm	VERDE	4000 tiras	12000 uds
373	10mm	4mm	AZUL	3000 tiras	9000 uds
374	10mm	5mm	NEGRO	3000 tiras	9000 uds

379	14mm	2mm	Blanco	3000 tiras	9000 uds
380	14mm	3mm	VERDE	3000 tiras	9000 uds
381	14mm	4mm	AZUL	2000 tiras	6000 uds
382	14mm	5mm	NEGRO	2000 tiras	6000 uds

10601	20mm	1mm	BEIGE	4000 tiras	12000 uds
390	20mm	2mm	ROJO	2000 tiras	6000 uds
391	20mm	3mm	BLANCO	2000 tiras	6000 uds
392	20mm	4mm	VERDE	1500 tiras	4500 uds
393	20mm	5mm	AZUL	1500 tiras	4500 uds
394	20mm	6mm	AMARILLO	1000 tiras	3000 uds
395	20mm	8mm	NEGRO	1000 tiras	3000 uds
388	20mm	10mm	MARRON	750 tiras	2250 uds
389	20mm	12mm	GRIS	700 tiras	2100 uds

383	18mm	3mm	BLANCO	1000 uds
384	18mm	4mm	VERDE	750 uds
385	18mm	5mm	AZUL	750 uds
386	18mm	6mm	AMARILLO	650 uds
387	18mm	7mm	NEGRO	500 uds



CODIGO	ANCHO	ESPESOR	COLOR	Nº TIRAS	CANTIDAD
■ 13720	20mm	1mm	MARRON	1000 tiras	3000 uds
■ 13721	20mm	2mm	AMARILLO	1000 tiras	3000 uds
■ 16907	20mm	3mm	ROJO	750 tiras	2250 uds
■ 13722	20mm	4mm	AZUL	500 tiras	1500 uds
■ 13723	20mm	5mm	VERDE	500 tiras	1500 uds
■ 13724	20mm	6mm	NEGRO	500 tiras	1500 uds
■ 13725	20mm	8mm	GRIS	350 tiras	1050 uds
■ 13726	20mm	10mm	DORADO	250 tiras	750 uds
■ 13727	20mm	12mm	VERDE OSC.	250 tiras	750 uds

## Pala acristalar

CODIGO	REF.
8877	102-002



## Surtido de calzos

CODIGO	MEDIDAS	CANTIDAD
■ 14825	10mm	250 uds (5,4,3,2 mm)
14777	14mm	
14963	20mm	20 uds (12,10) 30 uds (8) 50 uds (6,4) 100 uds (5,3)
■ 14952	22mm	70 uds(2) 60 uds (1)



**Limpiador - Abrillantador especial para aluminio y PVC.**

CODIGO	REF.	
■ 4855	DPD-10	5 lts



**Sellador protector de corrosión elástico e impermeable.**

CODIGO	REF.	COLOR	
■ 4856	CS-257	Transparente	12



**Adhesivo instantáneo**

CODIGO	REF.	
■ 19634	50411110005	60



Pegado instantáneo de juntas de goma

**Silicona DOW CORNING**

Siliconas neutras, acéticas, estructurales, sanitarias, acuarios, espejos, etc. Con una gran gama de colores: verde, rojo, piedra, gris, bronce, marrón, transparente, blanco, negro, etc.



**Film estirable.**

CODIGO	REF.	
■ 1679	FILM transparente (50 cm)	6
■ 1678	FILM transparente (10 cm)	60



**Rejilla ventilacion**

CODIGO	REF.	COLOR	
■ 3026	80x20	BLANCO	1
■ 4215	15x15	BLANCO	1



**Lámina aislante para chapa registro de persiana: Neopreno POLITEC TA con adhesivo 1 cara**

CODIGO	MEDIDA	ROLLO
18264	5x250	50
18265	5x300	50
18555	10x300	50

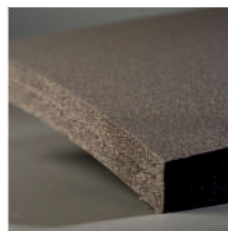

**CARACTERÍSTICAS DEL PRODUCTO:**

- Instalación simple y fácil
- Auto-Adhesivo por un lado
- Se adapta a cualquier caja de persiana
- Extremadamente flexible y de alta calidad
- Ahorro de energía

**APLICACIONES:**

- Para optimizar el comportamiento de aislamiento térmico y acústico de las cajas de persianas

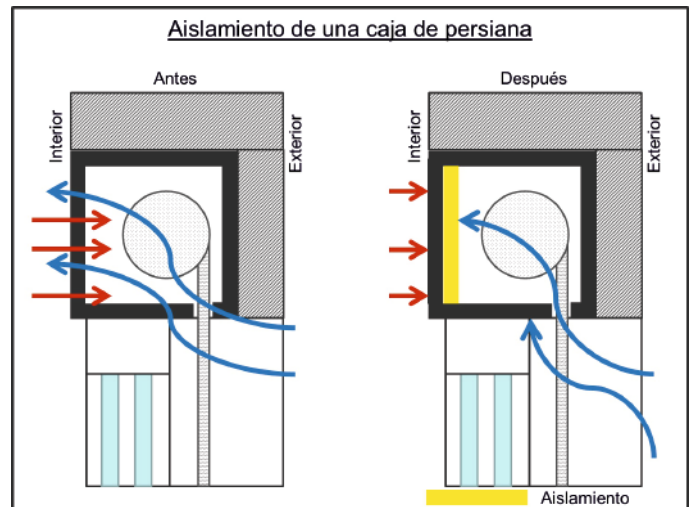



**NOTA:** Ver catálogo de mosquitera.

## Mosquitera corredera



Estas mosquiteras están indicadas para colocar sobre el marco de una ventana balconera o puerta corredera. El sistema dispone de rodamientos en su parte inferior para poder correrla de lado a lado sin problemas.

## Mosquitera enrollable



La mosquitera enrollable es de los modelos más habituales para instalar en ventanas, ya que permiten recogerse en invierno y desplegarse en verano.

18

## Mosquitera abatible



Mosquitera fija, indicada para instalar delante de una puerta de entrada. Una solución útil para cubrir zonas de paso continuo.

## Mosquitera plisada



Las mosquiteras plisadas son ideales para zonas de paso, debido a que no tienen marco inferior. Perfectas para grandes dimensiones. Elegante y muy duradera. También disponibles en tejido liso.

### Escuadra mosquitera centrada negra (con rodamientos de bolas)

CODIGO	REF.	
1650	EMC	400



### Escuadra mosquitera desplazada negra (con rodamientos de bolas)

CODIGO	REF.	
1653	EMD	400



### Escuadra mosquitera grande. Kit corte recto.

CODIGO	REF.	COLOR	
12683	TROPIC	Blanco	---
12684	TROPIC	Negro	---
19357	PERFILEX curvo	Blanco	75
19358	PERFILEX curvo	Negro	75



### Tela mosquitera. Color: Gris

CODIGO	MEDIDA	
2702	0,6 x 30 mts	18 m2
2703	0,8 x 30 mts	24 m2
2691	1 x 30 mts	30 m2
2692	1,2 x 30 mts	36 m2
2695	1,5 x 30 mts	45 m2





19

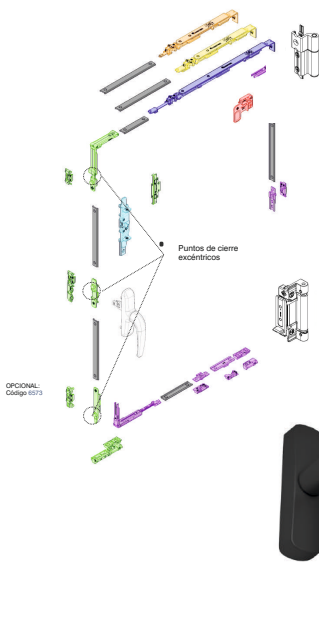

### Oscilo WEEN KARMA - COMPAS CORTO

CODIGO	MEDIDA	COLOR
25448	369/451	2100 sable
25451	369/451	Ral 7016 TXT
25454	369/451	Ral 7022 TXT
25457	369/451	Ral 8014 TXT
25460	369/451	Ral 9005 TXT
25463	369/451	Ral 9016 TXT

### Oscilo WEEN KARMA - COMPAS MEDIO

CODIGO	MEDIDA	COLOR
25449	450/651	2100 sable
25452	450/651	Ral 7016 TXT
25455	450/651	Ral 7022 TXT
25458	450/651	Ral 8014 TXT
25461	450/651	Ral 9005 TXT
25464	450/651	Ral 9016 TXT

### Oscilo WEEN KARMA - COMPAS LARGO

CODIGO	MEDIDA	COLOR
25450	650/1701	2100 sable
25453	650/1701	Ral 7016 TXT
25456	650/1701	Ral 7022 TXT
25459	650/1701	Ral 8014 TXT
25462	650/1701	Ral 9005 TXT
25465	650/1701	Ral 9016 TXT

### Basic kit oscilo SIN CREMONA

CODIGO	MEDIDA	COLOR
25353	650/1701	2100 sable
25348	650/1701	Ral 7016 TXT
25350	650/1701	Ral 7022 TXT
25352	650/1701	Ral 8014 TXT
25351	650/1701	Ral 9005 TXT
25349	650/1701	Ral 9016 TXT

### Compas ween

CODIGO	MEDIDA
14796	369/451
14728	450/651
14729	650/1701

**NOTA:** Para ventanas con medidas de 1200 o más utilizar compas suplementario CODIGO 6563.

### Juego bisagra 2ª hoja de 3 cuerpos regulable (con falso compás)

CODIGO	REF.	COLOR
25359	3400.23	2100 sable
25354	3400.23	Ral 7016 TXT
25356	3400.23	Ral 7022 TXT
25358	3400.23	Ral 8014 TXT
25357	3400.23	Ral 9005 TXT
25355	3400.23	Ral 9016 TXT



### Pasador Ween (incluye los cerraderos)

CODIGO	REF.	
15497	3420.51	5



### Pasador palanca Ween con punteras metalicas (incluye los cerraderos)

CODIGO	REF.	
11293	4515.52	5



### Punto cierre oculto

CODIGO	REF.	
8044	40809	50



### Ángulo extra de reenvío

CODIGO	REF.	
15494	3400G.31	10



### Kit microventilación regulable.

CODIGO	REF.		
15493	3400.39	pieza marco	1
6652	3520.39		1



**NOTA:** la ref. 3400.39 es para el compás mediano y grande. Para el compás pequeño hay que utilizar la ref 3520.39.

### Cremona oscilo con muelle KARMA

CODIGO	REF.	COLOR
25347	6061	2100 sable
25342	6061	Ral 7016 TXT
25344	6061	Ral 7022 TXT
25346	6061	Ral 8014 TXT
25345	6061	Ral 9005 TXT
25343	6061	Ral 9016 TXT



### Kit microventilacion practicable.

CODIGO	REF.
7348	33527

**NOTA:** Se necesitan 2 kits microventilación por hoja

### Empalme cremona + cerraderos.

CODIGO	REF.
25000	6111.13



## Bisagra CE eje inox pletina inox

CODIGO	REF.	COLOR	REF.
22211	1070.1	2100 sable	Dcha
22212	1070.1	2100 sable	Izqda
22209	1070.1	Ral 7016 TXT	Dcha
22210	1070.1	Ral 7016 TXT	Izqda
25382	1070.1	Ral 7022 TXT	Dcha
25383	1070.1	Ral 7022 TXT	Izqda
22213	1070.1	Ral 8014 TXT	Dcha
22214	1070.1	Ral 8014 TXT	Izqda
22207	1070.1	Ral 9005 TXT	Dcha
22208	1070.1	Ral 9005 TXT	Izqda
22205	1070.1	Ral 9016 TXT	Dcha
22206	1070.1	Ral 9016 TXT	Izqda



**NOTA:** Ver pag. 90 para datos técnicos.

## Bisagra CE 3ª hoja eje inox pletina inox

CODIGO	REF.	COLOR	REF.
22227	1075.1	2100 sable	Dcha
22228	1075.1	2100 sable	Izqda
22225	1075.1	Ral 7016 TXT	Dcha
22226	1075.1	Ral 7016 TXT	Izqda
25380	1075.1	Ral 7022 TXT	Dcha
25381	1075.1	Ral 7022 TXT	Izqda
22229	1075.1	Ral 8014 TXT	Dcha
22230	1075.1	Ral 8014 TXT	Izqda
22223	1075.1	Ral 9005 TXT	Dcha
22224	1075.1	Ral 9005 TXT	Izqda
22221	1075.1	Ral 9016 TXT	Dcha
22222	1075.1	Ral 9016 TXT	Izqda



**NOTA:** Ver pag. 91 para datos técnicos.

## Bisagra CE 4ª hoja eje inox pletina zamak

CODIGO	REF.	COLOR	REF.
22237	1090	2100 sable	Dcha
22238	1090	2100 sable	Izqda
22235	1090	Ral 7016 TXT	Dcha
22236	1090	Ral 7016 TXT	Izqda
25378	1090	Ral 7022 TXT	Dcha
25379	1090	Ral 7022 TXT	Izqda
22239	1090	Ral 8014 TXT	Dcha
22240	1090	Ral 8014 TXT	Izqda
22233	1090	Ral 9005 TXT	Dcha
22234	1090	Ral 9005 TXT	Izqda
22231	1090	Ral 9016 TXT	Dcha
22232	1090	Ral 9016 TXT	Izqda



**NOTA:** Ver pag. 91 para datos técnicos.

## Bisagra CE puerta eje inox pletina zamak

CODIGO	REF.	COLOR
22219	3000	2100 sable
22218	3000	Ral 7016 TXT
25384	3000	Ral 7022 TXT
22220	3000	Ral 8014 TXT
22217	3000	Ral 9005 TXT
22216	3000	Ral 9016 TXT



## Manilla multifunción KARMA

CODIGO	REF.	COLOR
25397	3100	2100 sable
25392	3100	Ral 7016 TXT
25394	3100	Ral 7022 TXT
25396	3100	Ral 8014 TXT
25395	3100	Ral 9005 TXT
25393	3100	Ral 9016 TXT



**NOTA:** Ver pag. 66-67 para datos técnicos.

## Manilla oculta 180º/90º multifunción

CODIGO	REF.	COLOR
25427	6397.19	2100 sable
25422	6397.19	Ral 7016 TXT
25424	6397.19	Ral 7022 TXT
25426	6397.19	Ral 8014 TXT
25425	6397.19	Ral 9005 TXT
25423	6397.19	Ral 9016 TXT



**NOTA:** Ver pag. 45 para datos técnicos.

## Manilla multifunción ACODADA DERECHA KARMA

CODIGO	REF.	COLOR
25409	3102S	2100 sable
25404	3102S	Ral 7016 TXT
25406	3102S	Ral 7022 TXT
25408	3102S	Ral 8014 TXT
25407	3102S	Ral 9005 TXT
25405	3102S	Ral 9016 TXT

## Manilla multifunción ACODADA IZQUIERDA KARMA

CODIGO	REF.	COLOR
25403	3102D	2100 sable
25398	3102D	Ral 7016 TXT
25400	3102D	Ral 7022 TXT
25402	3102D	Ral 8014 TXT
25401	3102D	Ral 9005 TXT
25399	3102D	Ral 9016 TXT



**NOTA:** La mano de la manilla es según el desplazamiento de la manilla y no de la posición de la manilla en la ventana.

**NOTA:** Ver pag. 66-67 para datos técnicos.

## Cierre multipunto EDGE ventana (165mm)

CODIGO	MEDIDA	COLOR	MANO	
23888	165mm	2100 sable	Derecha	20
23889	165mm	2100 sable	Izquierda	20
23876	165mm	Ral 7016 TXT	Derecha	20
23877	165mm	Ral 7016 TXT	Izquierda	20
25326	165mm	Ral 7022 TXT	Derecha	20
25327	165mm	Ral 7022 TXT	Izquierda	20
23882	165mm	Ral 8014 TXT	Derecha	20
23883	165mm	Ral 8014 TXT	Izquierda	20
23885	165mm	Ral 9005 TXT	Derecha	20
23886	165mm	Ral 9005 TXT	Izquierda	20
23879	165mm	Ral 9016 TXT	Derecha	20
23880	165mm	Ral 9016 TXT	Izquierda	20

**NOTA:** La manilla de derecha va colocada en la hoja izquierda y viceversa.

## Tirador exterior EDGE ventana

CODIGO	MEDIDA	COLOR	
23890	165mm	2100 sable	20
23878	165mm	7016 TXT	20
25325	165mm	7022 TXT	20
23884	165mm	8014 TXT	20
23887	165mm	9005 TXT	20
23881	165mm	9016 TXT	20



**NOTA:** Ver pag. 46 para datos técnicos.

**Cremona ap. interior KARMA**

CODIGO	REF.	COLOR
25365	6060	2100 sable
25360	6060	Ral 7016 TXT
25362	6060	Ral 7022 TXT
25364	6060	Ral 8014 TXT
25363	6060	Ral 9005 TXT
25361	6060	Ral 9016 TXT



**Kit 1ª hoja de nylon para CE con puntera regulable.**

CODIGO	REF.
■ 2452	Kc20510

**Kit 2ª hoja de nylon para CE con puntera regulable.**

CODIGO	REF.
■ 2454	Kc20510

**NOTA:** Ver pag. 66-67 para datos técnicos.

**Cremona ap. exterior KARMA**

CODIGO	REF.	COLOR
25371	6065.2	2100 sable
25366	6065.2	Ral 7016 TXT
25368	6065.2	Ral 7022 TXT
25370	6065.2	Ral 8014 TXT
25369	6065.2	Ral 9005 TXT
25367	6065.2	Ral 9016 TXT

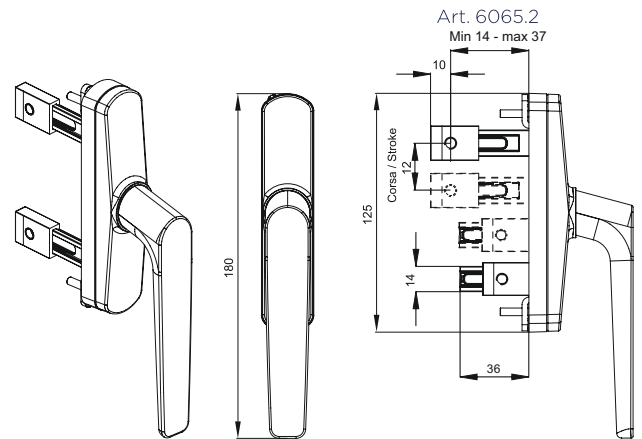

**Pernio M6**

CODIGO	REF.	
6128	15mm	1
2951	22mm	1

**Manilla recuperable KARMA**

CODIGO	REF.	COLOR
25391	3067	2100 sable
25386	3067	Ral 7016 TXT
25388	3067	Ral 7022 TXT
25390	3067	Ral 8014 TXT
25389	3067	Ral 9005 TXT
25387	3067	Ral 9016 TXT



**Embelledor KARMA**

CODIGO	REF.	COLOR
25377	2129.4	2100 sable
25372	2129.4	Ral 7016 TXT
25374	2129.4	Ral 7022 TXT
25376	2129.4	Ral 8014 TXT
25375	2129.4	Ral 9005 TXT
25373	2129.4	Ral 9016 TXT



**NOTA:** Ver pag. 66-67 para datos técnicos.

## Cierre golpete

CODIGO	REF.	COLOR
25421	1504.2	2100 sable
25416	1504.2	Ral 7016 TXT
25418	1504.2	Ral 7022 TXT
25420	1504.2	Ral 8014 TXT
25419	1504.2	Ral 9005 TXT
25417	1504.2	Ral 9016 TXT

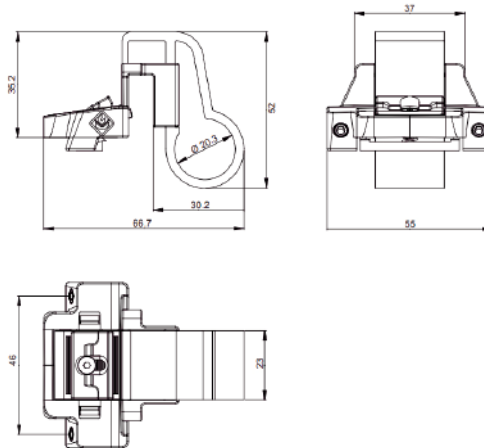

## Compas retenedor

CODIGO	REF.	MEDIDA
869	01	150 mm
872	02	250 mm

## Cierre corredera

CODIGO	REF.	COLOR
22282	4309	2100 sable
22281	4309	Ral 7016 TXT
25385	4309	Ral 7022 TXT
22283	4309	Ral 8014 TXT
22280	4309	Ral 9005 TXT
22279	4309	Ral 9016 TXT

**NOTA:** Ver pag. 28 para datos técnicos.



## Manilla elevable y uñero LINEA KARMA

CODIGO	REF.	COLOR
25415	3081.20	2100 sable
25410	3081.20	Ral 7016 TXT
25412	3081.20	Ral 7022 TXT
25414	3081.20	Ral 8014 TXT
25413	3081.20	Ral 9005 TXT
25411	3081.20	Ral 9016 TXT

**NOTA:** Ver pag. 66-67 para datos técnicos.



## Oscilo GALICUBE crudo

### 1. Kit base

CODIGO	REF.
13432	1461

### 2. Juego bisagras

CODIGO	REF.
23486	1410A

### 3. Compás

CODIGO	REF.	
23470	1447	364-700
23469	1447A	402-750
23471	1447B	562-1200
23472	1447C	816-1700

### 4. Cremona

CODIGO	REF.
17281	0530B

## Juego bisagras 2ª hoja Oscilo

CODIGO	REF.
23489	1414AI

## Manilla Multifuncion EOS. Linea OLIMPO

CODIGO	REF.
16512	0510A

## Manilla Multifuncion con llave EOS Linea OLIMPO

CODIGO	REF.
24729	0510A

## Manilla Multifuncion acodada. Linea OLIMPO

CODIGO	REF.	MANO
24635	0514AR	Dcha
24634	0514AL	Izda

## Manilla Multifuncion embutida

CODIGO	REF.
515	6397.1

## Cierre multipunto minimalista EDGE

CODIGO	REF.	MANO
23360	EDGE	Dcha
23361	EDGE	Izda

## Tirador exterior EDGE

CODIGO	REF.
23362	EDGE

## Manilla recuperable HERA. Linea OLIMPO. (Jgo)

CODIGO	REF.
17144	2041

## Embellecedor bombillo

CODIGO	REF.
18077	2100B

## Manilla elevable PRISMA

CODIGO	REF.
1815	5126AC

## Uñero

CODIGO	REF.	REF.
1816	5129ZA	11mm
23322	5129ZM	6,5mm

## Bisagra CE

CODIGO	REF.
16321	9730
18350	9730T (3ª HOJA)
17708	5603Q (4ªHOJA)

## Bisagra puerta CE MONZA

CODIGO	REF.
16992	5671

## Bisagra 4020

CODIGO	REF.
5956	1060.2
17220	1060.4 (3ª HOJA)
9275	1080 (4ª HOJA)

## Bisagra 2ª y 3ª hoja canal centrado

CODIGO	REF.
4469	1040.4

## Bisagra 4ª hoja canal centrado

CODIGO	REF.
17346	1040.5

## Cremona interior 2 palas GEA. Linea OLIMPO

CODIGO	REF.
17737	540B

## Cremona ap. exterior GAIA

CODIGO	REF.
23586	1800A
24275	1806A-PLANA
24061	1801A CYL (llave)

## Pernio M6

CODIGO	REF.	
6128	15mm	1
2951	22mm	1

## Golpete

CODIGO	REF.
15053	3217

## Cierre embutido OLE TOP sin tornillos

CODIGO	REF.
18910	5003DB

**NOTA:** El cierre necesita su propia uña. Consultar al depto. técnico.

**Cremona GAIA apertura exterior**

CODIGO	REF.	RAL
■ 24747	1800A	1011
■ 24748	1800A	1015
■ 24749	1800A	6002
■ 24750	1800A	6009
■ 24751	1800A	6009 mate
■ 24752	1800A	8007
■ 24753	1800A	8014



**Cremon GAIA PLANA apertura exterior**

CODIGO	REF.	RAL
■ 24754	1806A	1011
■ 24755	1806A	1015
■ 24756	1806A	6002
■ 24757	1806A	6009
■ 24758	1806A	6009 mate
■ 24759	1806A	8007
■ 24760	1806A	8014



**Pernio M6 INOX para cremona GAIA**

CODIGO	REF.	
6128	15mm	1
2951	22mm	1



**Cremona 6303 4 hojas con pernios**

CODIGO	REF.	RAL
■ 8563	6303	1011
■ 7302	6303	1015
■ 7301	6303	6002
■ 5105	6303	6009
■ 9615	6303	6009 mate
■ 7027	6303	8007
■ 5223	6303	8014



**Cremona 2008 apertura exterior**

CODIGO	REF.	RAL
■ 9617	2008	1011
■ 7305	2008	1015
■ 7304	2008	6002
■ 7303	2008	6009
■ 9618	2008	6009 mate
■ 7306	2008	8007
■ 9573	2008	8014



**Cierre 205 + pieza 567**

CODIGO	REF.	RAL
■ 18065	205	1011
■ 18970	205	1015
■ 18066	205	1015 mate
■ 18067	205	6002
■ 18813	205	6009
■ 18068	205	6009 mate
■ 18070	205	8007
■ 18069	205	8014 mate



**Manilla recuperable 7200**

CODIGO	REF.	RAL
■ 13042	7200	1011
■ 13043	7200	1015
■ 13044	7200	6002
■ 13046	7200	6009
■ 13045	7200	6009 mate
■ 13047	7200	8007
■ 13048	7200	8014



**Cierre presión 4940**

CODIGO	REF.	RAL
■ 9622	4940	1011
■ 9623	4940	1015
■ 4541	4940	6002
■ 9624	4940	6009
■ 9625	4940	6009 mate
■ 9626	4940	8007
■ 9628	4940	8014





**Bisagra 1070.1 2 hojas CE (eje inox).**

CODIGO	REF.		RAL
■ 4428	1070.1	Dcha	1011
■ 4429	1070.1	Izqda	1011
■ 1187	1070.1	Dcha	1015
■ 1204	1070.1	Izqda	1015
■ 1188	1070.1	Dcha	6002
■ 1205	1070.1	Izqda	6002
■ 1189	1070.1	Dcha	6009
■ 1206	1070.1	Izqda	6009
■ 9629	1070.1	Dcha	6009 mate
■ 9630	1070.1	Izqda	6009 mate
■ 9468	1070.1	Dcha	8007
■ 9469	1070.1	Izqda	8007
■ 9579	1070.1	Dcha	8014
■ 8606	1070.1	Izqda	8014



**Bisagra 1075.1 3ª hoja CE (eje inox).**

CODIGO	REF.		RAL
■ 9633	1075.1	Dcha	1011
■ 9634	1075.1	Izqda	1011
■ 9583	1075.1	Dcha	1015
■ 9580	1075.1	Izqda	1015
■ 9584	1075.1	Dcha	6002
■ 9581	1075.1	Izqda	6002
■ 12244	1075.1	Dcha	6009
■ 0289	1075.1	Izqda	6009
■ 9635	1075.1	Dcha	6009 mate
■ 9636	1075.1	Izqda	6009 mate
■ 9471	1075.1	Dcha	8007
■ 9470	1075.1	Izqda	8007
■ 9585	1075.1	Dcha	8014
■ 9582	1075.1	Izqda	8014



**Bisagra 1090.1 4ª hoja (eje inox)**

CODIGO	REF.	RAL
■ 9639	1090.1	1011
■ 1198	1090.1	1015
■ 1199	1090.1	6002
■ 1200	1090.1	6009
■ 9640	1090.1	6009 mate
■ 457	1090.1	8007
■ 0349	1090.1	8014



**Bisagra VENICE BABY 4ª hoja**

CODIGO	REF.	RAL
■ 18309	5603Q	1015
■ 16598	5603Q	6002
■ 15777	5603Q	6009
■ 17863	5603Q	6009 mate
■ 18420	5603Q	8007
■ 18419	5603Q	8014

**Bisagra 1040.4 2ª y 3ª hoja (eje inox)**

CODIGO	REF.		RAL
■ 3993	1040.4	Dcha	1011
■ 4055	1040.4	Izqda	1011
■ 3994	1040.4	Dcha	1015
■ 4056	1040.4	Izqda	1015
■ 3990	1040.4	Dcha	6002
■ 4053	1040.4	Izqda	6002
■ 3989	1040.4	Dcha	6009
■ 4052	1040.4	Izqda	6009
■ 3992	1040.4	Dcha	6009 mate
■ 7734	1040.4	Izqda	6009 mate
■ 4029	1040.4	Dcha	8007
■ 4059	1040.4	Izqda	8007
■ 8737	1040.4	Dcha	8014
■ 8736	1040.4	Izqda	8014



**Bisagra 1040.5 4ª hoja (eje inox)**

CODIGO	REF.	RAL
■ 5509	1040.5	1011
■ 6482	1040.5	1015
■ 5511	1040.5	6002
■ 5512	1040.5	6009
■ 7628	1040.5	6009 mate
■ 5510	1040.5	8007
■ 9586	1040.5	8014

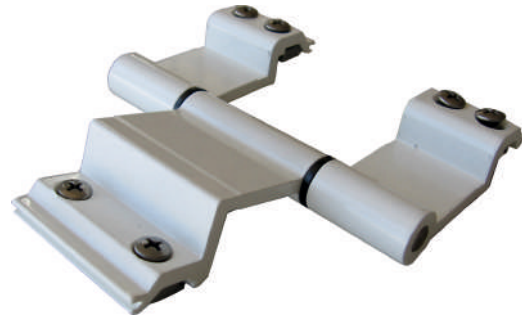

**Cerrojo. (varilla inox de 8 mm)  
Apertura interior**

CÓDIGO	REF.	COLOR	MEDIDAS	
■ 10289	323AI	6002	200	197
■ 10288		6009		
■ 19260		8007		
■ 19261		8014		
■ 10295	325AI	6002	300	297
■ 10294		6009		
■ 19265		8007		
■ 19266		8014		

**Puente bajo (varilla de 8 mm)**

CÓDIGO	COLOR
■ 19256	6002
■ 19257	6009
■ 19258	8007
■ 19259	8011



**Oscilo WEEN**

1. Basic Kit

CODIGO	REF.	COLOR
■ 16177	3400G.1	8007
■ 16192	3400G.1	8014
■ 19870	3400G.1	6009
15755	3400G.1	9010 BLANCO MATE

2. Compás

CODIGO	REF.	MEDIDAS
14796	3400.20	369-451
14728	3400.21	450-651
14729	3400.22	650-1701

3. Cremonas

CODIGO	REF.	COLOR
■ 8173	6015	8007
■ 8165	6015	8014
■ 19869	6015	6009
13211	6015	9010 BLANCO MATE

**Jgo bisagras 2ª hoja Oscilo**

CODIGO	REF.	COLOR
■ 16026	3420.23	8007
■ 17812	3420.23	8014
■ -----	3420.23	6009
14730	3420.23	9010 BLANCO MATE

**Bisagra TOP RAPID**

CODIGO	REF.	COLOR	MANO
■ 12475	9211.23	9010 BLANCO MATE	Dcha
■ 12476	9211.23	9010 BLANCO MATE	Izda

## ACABADO: ORO ANODIZADO

CODIGO	REF.	DESCRIPCIÓN
18834	D0117PD	Oscilo GALICUBE (562-1200)
18835	D0116PD	Oscilo GALICUBE (402-750)
■ 19090	D0062PD	Cremona oscilo BLANDA
18836	D060PD	Cremona ap. interior BLANDA
18983	D0067PD	Manilla multifunción BLANDA
18912	D0064PD	Manilla recuperable BLANDA
18837	D0113	Kit cremona izquierda BLANDA
18984	D0070PD	Embellecedor BLANDA
18838	1070.1PD	Bisagra 1070.1



19

## ACABADO: ORO VIEJO

CODIGO	REF.	DESCRIPCIÓN
5342	-----	Manilla multifunción
3925	-----	Bisagra PG CE eje inox dcha
3926	-----	Bisagra PG CE eje inox izqda
3927	-----	Bisagra PG 40x20 eje inox dcha
3928	-----	Bisagra PG 40x20 eje inox izqda
1122	-----	Cremona PG practicable
2449	-----	Manilla recuperable PG
14316	3500	Embellecedor



20

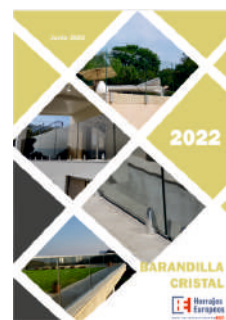







[www.herrajeseuropeos.com](http://www.herrajeseuropeos.com)



Herrajes Europeos S.L.  
Pol.Ind. Les Foies C/Forn del vidre sn  
CP.46830 Beniganim(Valencia)  
Tel. 962 920 314  
[herrajeseuropeos@herrajeseuropeos.com](mailto:herrajeseuropeos@herrajeseuropeos.com)